

PENNSYLVANIA

Stormwater BMP Manual

December 30, 2006



DEPARTMENT OF ENVIRONMENTAL PROTECTION  
Bureau of Watershed Management

**DOCUMENT NUMBER:** 363-0300-002

**TITLE:** Pennsylvania Stormwater Best Management Practices Manual

**EFFECTIVE DATE:** December 30, 2006

**AUTHORITY:** Pennsylvania Clean Streams Law (35 P.S. §§ 691.1-691.1001); Pennsylvania Stormwater Act (32 P.S. §§ 680.1-680.17); Federal Clean Water Act (33 U.S.C.A. § 1342), 40 CFR Part 122 and 25 Pa Code Chapters 92, 93, 102, 105 and 111.

**POLICY:** The Department will ensure that activities and plans approved under its authority will employ stormwater management plans utilizing best management practices to control the volume, rate and water quality of post construction stormwater runoff so as to protect and maintain the chemical, physical and biological properties of waters of the Commonwealth. These best management practices must, at a minimum, protect and maintain water resources, preserve water supplies, maintain stream base flows, preserve and restore the flood carrying capacity of waters, preserve to the maximum extent practicable the natural stormwater runoff regimes and natural course, current and cross section of waters of the Commonwealth, and protect and conserve ground waters and ground-water recharge areas.

**PURPOSE:** Clean, reliable water resources are critical for sustaining the environmental health of our natural resources, protecting the public's health and safety, and maintaining the economic vitality of the Commonwealth. The purpose of this guidance manual is to ensure effective stormwater management to minimize the adverse impacts of stormwater on ground water and surface water resources to support and sustain the social, economic and environmental quality of the Commonwealth.

**APPLICABILITY:** This guidance applies to all persons conducting or planning to conduct activities that require a written post-construction stormwater management plan.

**DISCLAIMER:** The policies and procedures outlined in this guidance are intended to supplement existing requirements. Nothing in the policies or procedures shall affect regulatory requirements. The guidelines herein are not an adjudication or a regulation. The Department reserves the discretion to vary from this guidance as circumstances warrant.

PAGE LENGTH: 642  
LOCATION: Volume 34, Tab 20  
DEFINITIONS: See Title 25 Pa. Code, Chapters 92, 93, 102, 105 and 111.

---

# Pennsylvania Stormwater Best Management Practices Manual

---

December 2006





# Table of Contents

## Foreword

## Chapter 1 Introduction and Purpose

1.1 Purpose of This Manual.....	1
1.2 How to Use This Manual.....	1
1.3 Overview of Pennsylvania's Existing Stormwater Management Program .....	3

## Chapter 2 Making The Case For Stormwater Management

2.1 A Brief Review of Stormwater Problems in Pennsylvania .....	1
2.2 The Hydrologic Cycle and The Effects of Development .....	4
2.2.1 Rainfall, Runoff, and Flooding.....	6
2.2.2 The Impacts of Vegetation Loss and Soil Changes .....	10
2.2.3 Groundwater Recharge, Stream Base Flow, and First Order Streams .....	10
2.2.4 Stream Channel Changes .....	13
2.2.5 Water Quality .....	14
2.3 References .....	19

## Chapter 3 Stormwater Management Principles and Recommended Control Guidelines

3.1 Introduction.....	1
3.2 Recommended Site Control Guidelines .....	1
3.3 Recommended Volume Control Guidelines.....	2
3.3.1 Volume Control Criteria.....	4
3.3.2 Volume Control Alternatives.....	5
3.3.3 Volume Control Guideline 1 .....	6
3.3.4 Volume Control Guideline 2.....	7
3.3.5 Retention and Detention Considerations .....	7
3.4 Recommended Peak Rate Control Guideline.....	8
3.5 Recommended Water Quality Control Guideline.....	8
3.6 Stormwater Standards for Special Areas.....	9

## Chapter 4 Integrating Site Design and Stormwater Management

4.1 A Recommended Site Design Procedure for Comprehensive Stormwater Management.....	1
4.2 The Site Design Checklist for Comprehensive Stormwater Management.....	3
4.3 Importance of Site Assessment.....	7
4.3.1 Background Site Factors.....	7
4.3.2 Site Factors Inventory .....	8
4.3.3 Site Factors Analysis.....	8







## **Chapter 5 Non-Structural BMPs**

5.1 Introduction .....	1
5.2 Non-Structural Best Management Practices.....	1
5.3 Non-Structural BMPs and Stormwater Methodological Issues .....	3
5.4 Protect Sensitive and Special Value Resources.....	5
BMP 5.4.1 Protect Sensitive and Special Value Features .....	7
BMP 5.4.2 Protect/Conserve/Enhance Riparian Areas .....	13
BMP 5.4.3 Protect/Utilize Natural Flow Pathways in Overall Stormwater Planning and Design .....	21
5.5 Cluster and Concentrate.....	27
BMP 5.5.1 Cluster Uses at Each Site; Build on the Smallest Area Possible .....	29
BMP 5.5.2 Concentrate Uses Areawide through Smart Growth Practices .....	37
5.6 Minimize Disturbance and Minimize Maintenance.....	47
BMP 5.6.1 Minimize Total Disturbed Area – Grading .....	49
BMP 5.6.2 Minimize Soil Compaction in Disturbed Areas .....	57
BMP 5.6.3 Re-Vegetate and Re-Forest Disturbed Areas, Using Native Species .....	63
5.7 Reduce Impervious Cover .....	69
BMP 5.7.1 Reduce Street Imperviousness .....	71
BMP 5.7.2 Reduce Parking Imperviousness .....	77
5.8 Disconnect / Distribute / Decentralize.....	82
BMP 5.8.1 Rooftop Disconnection.....	85
BMP 5.8.2 Disconnection from Storm Sewers.....	89
5.9 Source Control.....	92
BMP 5.9.1 Streetsweeping .....	95

## **Chapter 6 Structural BMPs**

6.1 Introduction .....	1
6.2 Groupings of Structural BMPs .....	1
6.3 Manufactured Products.....	2
6.4 Volume/Peak Rate Reduction by Infiltration BMPs.....	5
BMP 6.4.1 Pervious Pavement with Infiltration Bed.....	7
BMP 6.4.2 Infiltration Basin .....	27
BMP 6.4.3 Subsurface Infiltration Bed.....	33
BMP 6.4.4 Infiltration Trench .....	41
BMP 6.4.5 Rain Garden/Bioretenion .....	49
BMP 6.4.6 Dry Well / Seepage Pit.....	67
BMP 6.4.7 Constructed Filter.....	71
BMP 6.4.8 Vegetated Swale.....	83
BMP 6.4.9 Vegetated Filter Strip .....	99
BMP 6.4.10 Infiltration Berm & Retentive Grading.....	113



6.5 Volume/Peak Rate Reduction BMPs .....	123
BMP 6.5.1 Vegetated Roof .....	125
BMP 6.5.2 Runoff Capture & Reuse .....	139
6.6 Runoff Quality/Peak Rate BMPs.....	149
BMP 6.6.1 Constructed Wetland.....	151
BMP 6.6.2 Wet Pond/Retention Basin .....	163
BMP 6.6.3 Dry Extended Detention Basin .....	173
BMP 6.6.4 Water Quality Filters & Hydrodynamic Devices .....	183
6.7 Restoration BMPs.....	189
BMP 6.7.1 Riparian Buffer Restoration.....	191
BMP 6.7.2 Landscape Restoration .....	211
BMP 6.7.3 Soil Amendment & Restoration .....	221
BMP 6.7.4 Floodplain Restoration .....	231
6.8 Other BMPs and Related Structural Measures.....	241
BMP 6.8.1 Level Spreader.....	243
BMP 6.8.2 Special Detention Areas - Parking Lot, Rooftop.....	253

## **Chapter 7 Special Management Areas**

7.1 Introduction .....	1
7.2 Brownfields .....	1
7.2.1 Site Remediation (i.e. Cleanup).....	2
7.2.2 Site Redevelopment .....	2
7.3 Highways and Roads.....	3
7.3.1 Roadway Runoff Quality Issues.....	4
7.3.2 BMP Considerations for Roadways .....	5
7.3.3 Specific BMP Considerations .....	9
7.3.4 Gravel Roads.....	10
7.4 Karst Areas .....	11
7.4.1 The Nature of Karst .....	11
7.4.2 Infiltration vs non-infiltration .....	12
7.4.3 Basic Principles .....	13
7.4.4 BMP Considerations .....	15
7.5 Mined Lands .....	16
7.6 Stormwater Management Close to Water Supply Wells.....	17
7.7 Surface Water Supplies and Special Protection Waters.....	20
7.8 Urban Areas .....	21
7.8.1 Highly Impervious Urban Land .....	21
7.8.2 Urban Water Quality .....	22
7.8.3 Other Urban Stormwater Management Considerations.....	24
7.9 References .....	25



## Chapter 8 Stormwater Calculations and Methodology

8.1 Introduction to Stormwater Methodologies .....	1
8.2 Existing Methodologies for Runoff Volume Calculations and their Limitations .....	1
8.2.1 Runoff Curve Number Method .....	1
8.2.2 Small Storm Hydrology Method .....	2
8.2.3 Infiltration Models for Runoff Calculations.....	3
8.3 Existing Methodologies for Peak Rate/Hydrograph Estimations and their Limitations .....	3
8.3.1 The Rational Method.....	3
8.3.2 SCS (NRCS) Unit Hydrograph Method .....	4
8.4 Computer Models .....	4
8.4.1 HEC Hydrologic Modeling System (HEC-HMS).....	4
8.4.2 SCS/NRCS Models: WIN TR-20 and WIN TR-55 .....	5
8.4.3 EFH2 .....	5
8.4.4 Storm Water Management Model (SWMM) .....	5
8.4.5 Source Loading and Management Model (SLAMM) .....	6
8.5 Precipitation Data for Stormwater Calculations .....	6
8.6 Stormwater Quality Management .....	7
8.6.1 Analysis of Water Quality Impacts from Developed Land .....	8
8.6.2 Analysis of Water Quality Benefits from BMPs .....	10
8.6.3 Water Quality Analysis .....	12
8.7 Guidance for Stormwater Calculations for CG1 and CG2 .....	13
8.7.1 Stormwater Calculation Process .....	14
8.7.1.1 For Control Guideline 1 (Flow Chart B).....	14
8.7.1.2 For Control Guideline 2 (Flow Chart C) .....	15
8.7.2 Water Quality Calculations (Flow Chart D).....	16
8.8 Non-structural BMP Credits .....	17
8.9 References and Additional Sources .....	45



## **Chapter 9 Case Studies: Innovative Stormwater Management Approaches and Practices**

9.1 Introduction .....	1
9.2 Outline of Information Needed for Case Studies .....	2
9.3 Case Studies .....	3
Case Study 1: Penn State University - Centre County Visitor Center, Centre County .....	3
Case Study 2: Dennis Creek Streambank Restoration, Franklin County .....	10
Case Study 3: Commerce Plaza III, Lehigh County .....	11
Case Study 4: Flying J. Truck Plaza for Welsh Oil of Indiana Truck Refueling Terminal .....	13
Case Study 5: Ephrata Performing Arts Center, Lancaster County .....	16
Case Study 6: Lebanon Valley Agricultural Center, Lebanon County .....	18
Case Study 7: Penn State University Berks County Campus, Berks County .....	19
Case Study 8: Warm Season Meadows at Williams Transco, Chester County.....	22
Case Study 9: Hills of Sullivan Residential Subdivision, Chester County.....	24
Case Study 10: Applebrook Golf Course Community, Chester County.....	28
Case Study 11: Swan Lake Drive Development, Delaware County .....	30

### **Appendix A - Water Quality**

### **Appendix B - Pennsylvania Native Plant List**

### **Appendix C - Protocols for Structural BMPs**

Protocol 1 – Site Evaluation and Soil Infiltration Testing

Protocol 2 – Soil Evaluation and Investigation for Infiltration BMPs

### **Appendix D - Stormwater Calculations and Methodology – Case Study**

### **Glossary**





## FOREWORD

Stormwater runoff and flooding are natural events that, over the millennia, have helped shape the world around us. Our activities on the landscape routinely alter these natural drainage patterns by intensifying and redirecting runoff, potentially leading to stream pollution, property damage and, in extreme cases, loss of life.

Localized flash flooding, stream bank scour and destabilization, siltation, loss of ground water recharge, declining dry-weather stream flows and habitat destruction are all the results of unmanaged or poorly managed stormwater. In addition to its physical impact on the environment, stormwater may carry a variety of pollutants into our waters including metals, bacteria, oil and grease, pesticides, nutrients and sediment. The Department's stream assessment efforts have documented that urban runoff is the third leading source of stream impairment in Pennsylvania. Moving forward, these historic problems can be avoided or minimized through a combination of forethought and planning, and properly constructed and maintained best management practices (BMPs). By managing stormwater runoff as a valuable and reusable resource rather than as a waste that must be quickly moved away, a host of opportunities are opened that promote environmental protection and enhancement while complementing new growth and development.

This manual is based on the following set of principles:

1. Managing stormwater as a resource;
2. Preserving and utilizing existing natural features and systems;
3. Managing stormwater as close to the source as possible;
4. Sustaining the hydrologic balance of surface and ground water;
5. Disconnecting, decentralizing and distributing sources and discharges;
6. Slowing runoff down, and not speeding it up;
7. Preventing potential water quality and quantity problems;
8. Minimizing problems that cannot be avoided;
9. Integrating stormwater management into the initial site design process; and
10. Inspecting and maintaining all BMPs.

The manual supplements federal and state regulations, and the Department's Comprehensive Stormwater Management Policy, by emphasizing effective site planning as the preferred method of managing runoff while also providing numerous examples of BMPs that can be employed in Pennsylvania to further avoid and minimize flooding and water resource problems. This manual has no independent regulatory authority. The manual is intended to be a technical reference of planning concepts and design standards that will satisfy Pennsylvania's regulatory requirements and stormwater management policies when properly tailored and applied to local site conditions. Alternate BMPs not listed in the manual may also be used to satisfy regulatory requirements if they provide the same or greater level of protection. No predetermined set of practices will be applicable to every building site. Specific considerations such as soil type, underlying geology, slope, project size and building density will determine which practices are applicable and feasible for a given project.



## Acknowledgements

The following individuals and organizations participated in developing this manual. Participation does not infer concurrence or endorsement of the manual or its contents.

### **Stormwater Manual Oversight Committee**

Special thanks are expressed to the members of the Stormwater Manual Oversight Committee who assisted in providing direction, guidance and expertise in the preparation of this manual. Committee members include:

Kevin Abbey, Center for Dirt and Gravel Road Studies, Pennsylvania State University  
John Amend, Malcolm Pirnie, Inc.  
Mark A. Bahnick, P.E., Van Cleef Engineering Associates  
Theresa M. Bentley, Bucks County Planning Commission  
Joan Blaustein, Three Rivers Wet Weather, Inc.  
Scott A. Brown, P.E., The Pennsylvania Housing Research Center  
Frank X. Browne, PhD, P.E., F.X. Browne, Inc.  
Albert T. Brulo, P.E., Herbert Rowland & Grubic, Inc.  
Rebecca Burns, Pennsylvania Department of Transportation  
Paul A. DeBarry, P.E., P.H., Borton-Lawson Engineering, Inc.  
Warren Neal Cohn, ACF Environmental  
Timothy J. Edinger, P.E., Base Engineering, Inc.  
Lawrence A. Fennessey, PhD, P.E., Sweetland Engineering & Assoc., Inc.  
Dan Greig, District Manager, Chester County Conservation District  
David Klepadlo, P.E., Malcolm Pirnie, Inc.  
Anthony Miller, P.E., Pennsylvania Department of Transportation  
Timothy J. Murphy, P.E., Natural Resources Conservation Service  
Scott Pidcock, P.E., R.A., The Pidcock Company  
James W. Pillsbury, P.E., Westmoreland County Conservation District  
Bruce R. Snyder, Atlas America, Inc.  
Mike M. Stadulis, Realen Homes  
Thaddeus K. Stevens, President, Sylvan Glen, Inc.  
Albert H. Todd, U.S. Forest Service  
Robert G. Traver, PhD, P.E., Civil and Environmental Engineering Department, Villanova University  
Maya K. van Rossum, the Delaware Riverkeeper, Delaware Riverkeeper Network  
Paul White, P.G., Walter B. Satterthwaite Assoc., Inc.  
Kerry Wilson, Pennsylvania Department of Community and Economic Development  
Paul Zeigler, P.E., Governors Green Government Council

### **Pennsylvania Department of Environmental Protection**

Committee Members: Steven Burgo, Stuart Demanski, Durla Lathia, Margaret Murphy, Kenneth Murin, Kenneth Reisinger, Edward Ritzer, Dennis Stum, and Raymond Zomok

Special technical assistance and editing provided by Patrick Bowling, Stuart Demanski, Stuart Gansell, Dave Goerman, Joseph Hebelka, Cedric Karper, William Kochnov, Sharon Hill, William Manner, Jeffrey Means, Claudia Merwin, Barry Newman, Tahmina Parvin, Frank Payer, Shelby Reisinger, Domenic Rocco, and Diane Wilson.

## **Contractor and Supporting Project Teams**

### Contractor Team

Michele Adams, P.E., Thomas Cahill, P.E., Wesley Hoerner, and Courtney Marm of Cahill Associates Inc., West Chester, PA

### Supporting Project Team

Amy Green, Amy Green Associates, Flemington, NJ  
Charles Miller, P.E., Roofscapes, Philadelphia, PA  
Ann Smith, Pennsylvania Environmental Council, Philadelphia, PA  
Eric Strecker, P.E., and Steven Roy, P.S., GeoSyntec Consultants, Boxborough, MA  
Neil Weinstein, P.E., Low Impact Development Center, Inc., Rockville, MD

---

# Pennsylvania Stormwater Best Management Practices Manual

---

## Chapter 1

### Introduction and Purpose





## **Chapter 1      Introduction and Purpose**

<b>1.1</b>	<b>Purpose of this Manual.....</b>	<b>1</b>
<b>1.2</b>	<b>How to Use this Manual.....</b>	<b>1</b>
<b>1.3</b>	<b>Overview of Pennsylvania’s Existing Stormwater Management Program....</b>	<b>3</b>





## 1.1 Purpose of this Manual

The purpose of the Pennsylvania Stormwater Best Management Practices (BMP) Manual is to provide guidance, options and tools that can be used to protect water quality, enhance water availability and reduce flooding potential through effective stormwater management. This manual presents design standards and planning concepts for use by local authorities, planners, land developers, engineers, contractors, and others involved with planning, designing, reviewing, approving, and constructing land development projects.

This manual describes a stormwater management approach to the land development process that strives to:

- First, prevent or minimize stormwater problems through comprehensive planning and development techniques, and
- Second, to mitigate any remaining potential problems by employing structural and non-structural BMPs.

Manual users are strongly encouraged to follow the progression of prevention first and mitigation second. Throughout the chapters of this manual the concept of an integrated stormwater management program, based on a broad understanding of the natural land and water systems, is a key and recurring theme. Such a thorough understanding of the natural systems demands an integrated approach to stormwater management, so critical to “doing it better, doing it smarter.”

This manual provides guidance on managing all aspects of stormwater: rate, volume, quality, and groundwater recharge. Controlling the peak rate of flow during extreme rainfall events is important, but it is not sufficient to protect the quality and integrity of Pennsylvania streams. Reducing the overall volume of runoff during large and small rainfall events, improving water quality, and maintaining groundwater recharge for wells and stream flow are all vital elements of protecting and improving the quality of Pennsylvania’s streams and waterways.

It is important to note that The Pennsylvania Stormwater Best Management Practice Manual has no independent regulatory authority. The strategies, practices, recommendations and control guidelines presented in the manual can become binding requirements only through the following means:

1. Ordinances and rules established by local municipalities, or
2. Permits and other authorizations issued by local, state, and federal agencies.

## 1.2 How to Use this Manual

The following provides a guide to the various chapters of the Manual.

### **Chapter 1 – Introduction and Purpose**

### **Chapter 2 – Stormwater and the Impacts of Development and Impervious Surfaces**

This section provides an overview of the impacts of development on Pennsylvania’s natural systems and natural resources, including discussions about the effect of increased runoff volumes, water quality, stream channel erosion, flooding, and lost groundwater recharge and stream baseflow.

### **Chapter 3 – Stormwater Management Principles and Recommended Control Guidelines**

This section discusses stormwater management principles to protect water resources and provides recommended control guidelines for stormwater management. This chapter also discusses how the recommended guidelines relate to diverse conditions, such as urban areas rural settings, brownfield sites and karst topography.

### **Chapter 4 – Integrating Site Design and Stormwater Management**

This section discusses the *process* of comprehensive stormwater management, which begins with better site design and protection of important natural features first, and the use of structural Best Management Practices to manage stormwater second. An approach to site design and stormwater management for Pennsylvania is outlined in flowchart and checklist formats.

### **Chapter 5 – Non-Structural BMPs**

This section describes in detail 13 design and development techniques (non-structural BMPs) that reduce the impact of stormwater. It includes both specific design practices and recommendations that may be required or encouraged by municipal officials within the context of zoning and land development ordinances. Use of these “non-structural” BMPs is considered to be the primary means of stormwater management.

### **Chapter 6 – Structural BMPs**

This section describes in detail 21 specific engineering measures that reduce and mitigate the impacts of development. The use of the “structural BMPs” is considered the second step in stormwater design. Chapter 6 includes recommendations (protocols) for the design of infiltration systems and for soil investigation for infiltration systems.

### **Chapter 7 – Special Management Areas**

This chapter discusses issues and stormwater management implications unique to some special management areas such as brownfields, highways and roads, karst areas, mined lands, water supply well areas, surface water supplies, special protection waters, and highly urbanized areas.

### **Chapter 8 – Stormwater Calculations and Methodology**

This chapter discusses engineering techniques and methods used to perform stormwater calculations. Improved sources for rainfall estimates (NOAA Atlas 14, 2004) are suggested. This chapter also provides guidance on developing stormwater calculations based on the recommended control guidelines in Chapter 3 of the manual. In addition, this chapter includes optional flowcharts and worksheets to assist stormwater designers and reviewers organize and conduct their calculations.

### **Chapter 9 - Case Studies**

This chapter presents case studies of projects that have been implemented throughout Pennsylvania that incorporate innovative techniques and approaches to stormwater management. This chapter identifies sites in various regions of the state that users of the manual may visit to observe innovative stormwater management techniques in a range of development settings.

**Appendix A – Water Quality****Appendix B – Pennsylvania Native Plant List****Appendix C – Protocols for Structural BMPs**

Protocol 1 – Site Evaluation and Soil Infiltration Testing  
Protocol 2 – Infiltration Systems Design and Construction Guideline

**Appendix D – Storm water Calculations and Methodology – Case Study****Glossary****1.3 Overview of Pennsylvania’s Existing Stormwater Management Program**

The Clean Stream Law of 1937 provides the legal foundation for water quality protection and restoration, and water resources management in Pennsylvania. The Department of Environmental Protection is primarily responsible for administering the provisions of the act. The Clean Streams Law has been affected by passage of a series of federal laws, such as the Clean Water Act (CWA) of 1972, which has also been amended over time. Local government implements specific regulations for land development and stormwater management. Pennsylvania has 2566 municipalities and 376 designated stormwater management watersheds, with diverse natural, social, and cultural features. The Pennsylvania Municipalities Planning Code (MPC) law enables, but does not require, comprehensive planning, zoning, and subdivision/land development regulation on the municipal, county, and regional levels. To achieve regulatory status, the recommendations and guidelines in this manual must be implemented by ordinances and zoning at the municipal level.

The Pennsylvania Storm Water Management Act of 1978 (Act 167) provides the legislative basis for statewide stormwater management. The Act 167 stormwater management program is mandated, administered, and funded at a 75 percent level by the state. However, stormwater management plans must be developed by the respective counties in a given watershed, and be implemented by the effected municipalities through the adoption of stormwater ordinances. This is a rather uniquely structured “sharing” of authority and powers by all levels of Pennsylvania government. In addition to the requirements under local zoning and ordinances, federal regulations require individual land development projects to obtain National Pollutant Discharge Elimination System (NPDES) permits. These permits are required for all land development projects that disturb one acre or more. The permits authorize discharges from erosion and sediment control facilities and approve post-construction stormwater management plans. The 1999 update to the federal stormwater regulations also required 923 small municipalities and numerous institutions throughout Pennsylvania to obtain NPDES permits for their stormwater discharges. Each permit holder must implement and enforce a stormwater management program that reduces the discharge of pollutants to the maximum extent practicable. More detailed discussions of individual and municipal NPDES construction and stormwater management permits can be found on the DEP web site under the keyword “Stormwater Management”.



---

# **Pennsylvania Stormwater Best Management Practices Manual**

---

## **Chapter 2**

### **Making the Case for Stormwater Management**





## Chapter 2 Making the Case for Stormwater Management

2.1	A Brief Review of Stormwater Problems in Pennsylvania.....	1
2.2	The Hydrologic Cycle and the Effects of Development.....	4
2.2.1	Rainfall, Runoff, and Flooding.....	6
2.2.2	The Impacts of Vegetation Loss and Soil Changes.....	10
2.2.3	Groundwater Recharge, Stream Base Flow, and First-Order Streams.....	10
2.2.4	Stream Channel Changes.....	13
2.2.5	Water Quality.....	14
2.3	References.....	19





## 2.1 A Brief Review of Stormwater Problems in Pennsylvania

Pennsylvania is the most flood prone state in the country. It has experienced several serious and sometimes devastating floods during the past century, often as a result of tropical storms and hurricanes, and heavy rainfall on an existing snow pack. To a large extent, the flooding that results from such extreme storms and hurricanes occurs naturally and will continue to occur. Stormwater management cannot eliminate flooding during such severe rainfall events (Figure 2-1).



*Figure 2-1. Flooding impacts are devastating communities, even with conventional stormwater management programs (F. Thorton).*

In many watersheds throughout the state, flooding problems from rain events, including the smaller storms, have increased over time due to changes in land use and ineffective stormwater management. This additional flooding is a result of an increased volume of stormwater runoff being discharged throughout the watershed. This increase in stormwater volume is the direct result of more extensive impervious surface areas (Figure 2-2), combined with substantial tracts of natural landscape being converted to lawns on highly compacted soil or agricultural activities.



*Figure 2-2. Parking lots are common impervious surfaces that affect stormwater runoff.*

The problems are not limited to flooding. Stormwater runoff carries significant quantities of pollutants washed from the impervious and altered land surfaces (Figure 2-3). The mix of potential pollutants ranges from sediment to varying quantities of nutrients, organic chemicals, petroleum hydrocarbons, and other constituents that cause water quality degradation.



*Figure 2-3. Pollutant laden runoff degrades water quality.*

Increased stormwater runoff volume can turn small meandering streams into highly eroded and deeply incised stream channels (Figure 2-4). Stream meander and the resulting erosion and sedimentation is a natural process, and all channels are in a constant process of alteration. However, as the volume of runoff from each storm event is increased, natural stream channels experience more frequent bank full or near bankfull conditions. As a result, streams change their natural shape and form. Pools and riffles that support aquatic life are disrupted as channels erode to an unnatural level, and the eroded bank material contributes to sediment in the stream and degrades it's health by smothering stream bottom habitat. The majority of this stream channel devastation is intensified during the frequently occurring small-to-moderate precipitation events, not during major flooding events.



*Figure 2-4. Stormwater influenced stream bank morphology in Valley Creek.*

Rainfall is an important resource to replenish the groundwater and maintain stream flow (Figure 2-5). When the stormwater runoff during a storm event is allowed to drain away rather than recharge the groundwater, it alters the hydrologic balance of the watershed. As a consequence, stream base flow is deprived of the constant groundwater discharge and may diminish or even cease. During a drought, reduced stream base flow may also significantly affect the water quality in a stream.

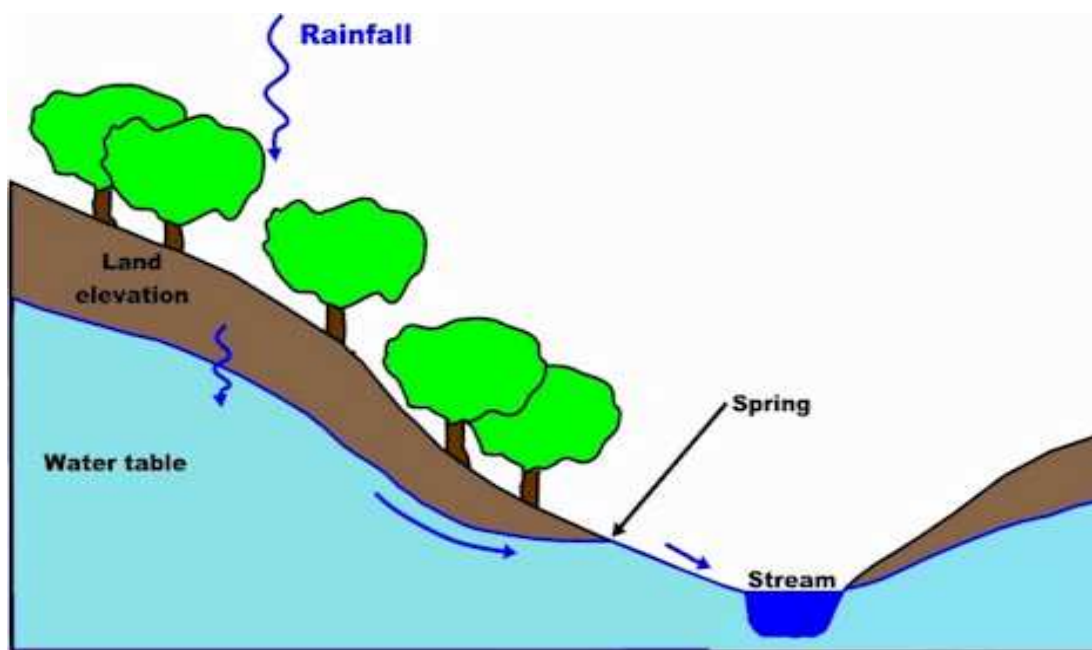


Figure 2-5. Rainfall replenishes the groundwater, which in turn provides stream base flow.

The groundwater discharge to a stream is at a relatively constant temperature, whereas stormwater runoff from impervious surfaces may be very hot in the summer months and extremely cold in the winter months. These temperature extremes can have a devastating effect on aquatic organisms, from bacteria and fungi to larger species. Many fish, especially native trout, can be harmed by acute temperature changes of only a few degrees.

Improperly managed stormwater causes increased flooding, water quality degradation, stream channel erosion, reduced groundwater recharge, and loss of aquatic species. But these and other impacts can be effectively avoided or minimized through better site design. This chapter discusses the potential problems associated with stormwater and explains the need for better stormwater management. The problems caused by impervious and altered surfaces can be avoided or minimized, but only through stormwater management techniques that include runoff volume reduction, pollutant reduction, groundwater recharge and runoff rate control for all storms.

## 2.2 The Hydrologic Cycle and The Effects of Development

The movement of water from the atmosphere to the land surface and then back to the atmosphere is a continuous process, with water constantly in motion. This balanced water cycle of precipitation, runoff, evapotranspiration, infiltration, groundwater recharge, and stream base flow sustains Pennsylvania’s water resources. This representation of the hydrologic cycle, while depicting the general concept, over-simplifies the complex interactions that define the surface and subsurface flow processes of humid regions in the United States.

Changes to the land surface, along with inappropriate stormwater management, can significantly alter the natural hydrologic cycle. In a natural Pennsylvania woodland or meadow, very little of the annual rainfall leaves the site as runoff. More than half of the annual amount of rainfall returns to the atmosphere through evapotranspiration. Surface vegetation, especially trees, transpires water to the atmosphere (with seasonal variations). Water is also stored in puddles, ponds and lakes on the earth’s surface, where some of it will evaporate. Water that percolates through the soil either moves vertically and eventually reaches the zone of saturation or water table, moves laterally through the soil and often emerges as springs or seeps down gradient or is stored in the soil.

Soils are influenced and formed by vegetation, climate, parent material, topography and time. All of these factors have some effect on how water will move through the soil. Restrictive soil horizons may impede the vertical movement of water and cause it to move laterally. It is important to understand these factors when designing an appropriate stormwater system at a particular location. Under natural woodland and meadow conditions, only a small portion of the annual rainfall becomes stormwater runoff. Although the total amount of rainfall varies in different regions of the state, the basic average hydrologic cycle shown below holds true (Figure 2-6).

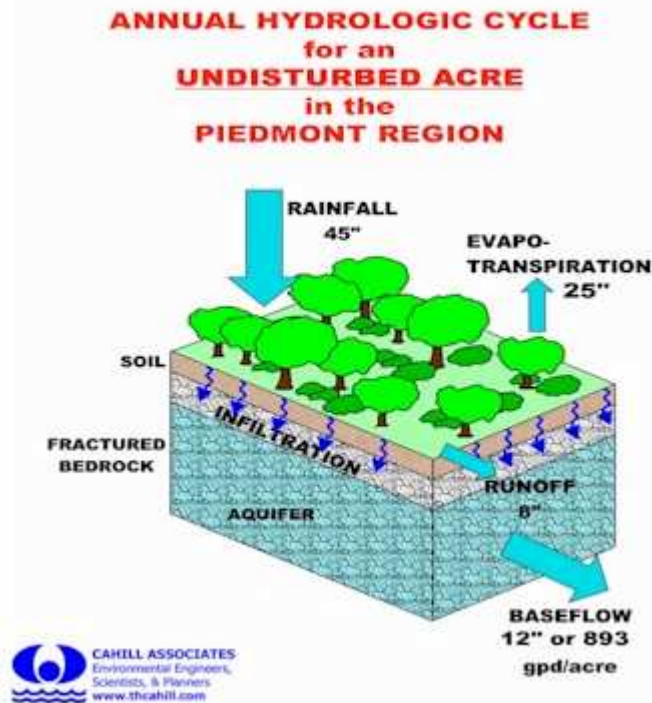


Figure 2-6. Annual hydrologic cycle for an undisturbed acre in the Pennsylvania Piedmont region.

Changing the land surface causes varying changes to the hydrologic cycle (Figure 2-7). Altering one component of the water cycle invariably causes changes in other elements of the cycle. Roads, buildings, parking areas and other impervious surfaces prevent rainfall from soaking into the soil and significantly increase the amount of runoff. As natural vegetation is removed, the amount of evapotranspiration decreases.

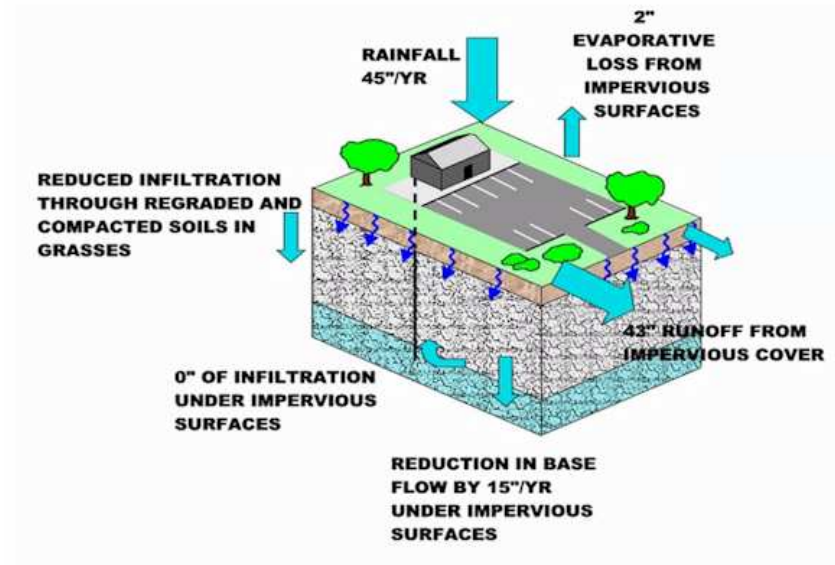


Figure 2-7. Representative altered hydrologic cycle for a developed acre in the Piedmont region.

These changes in the hydrologic cycle have a dramatic effect on streams and water resources. Annual stormwater runoff volumes increase from inches to feet per acre, groundwater recharge decreases, stream channels erode, and populations of fish and other aquatic species decline. Past practices focused on detaining the peak flows for larger storms. While detention is helpful in reducing peak flows for the immediate downstream neighbor, it does not address most of the other problems discussed earlier.

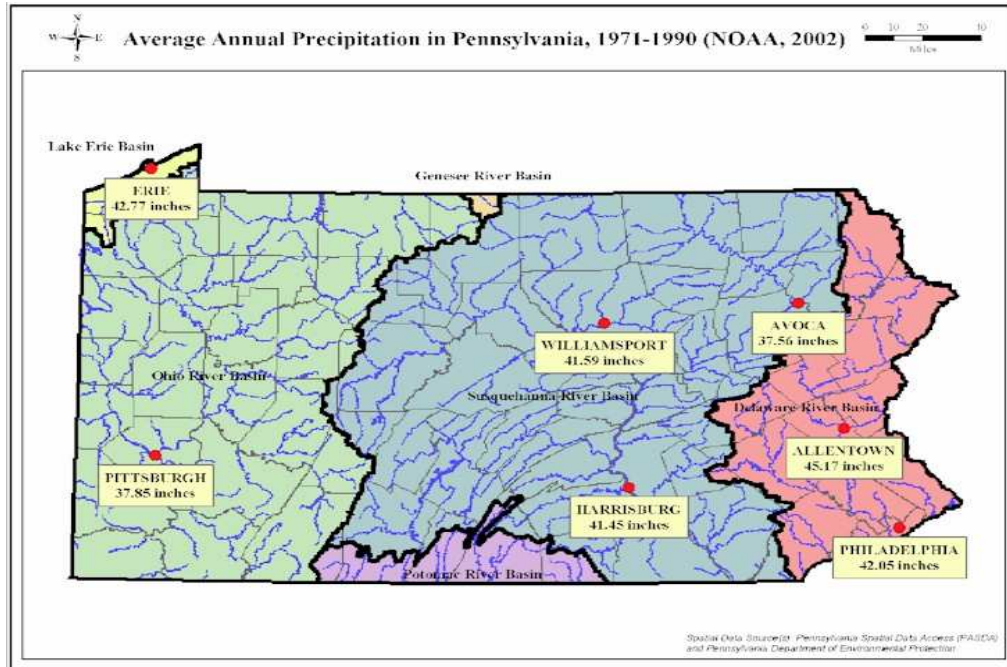


Figure 2-8. Average annual precipitation in Pennsylvania.

### 2.2.1 Rainfall, Runoff, and Flooding

In Pennsylvania, average annual precipitation ranges from 37 inches to more than 45 inches per year (Figure 2-8), and reflects a humid pattern. Nearly all of the annual rainfall occurs in small storm events (Figure 2-9). Precipitation of an inch or less is frequent and well distributed throughout the year. However, large storms, hurricanes, and periods of intense rainfall can occur at any time.

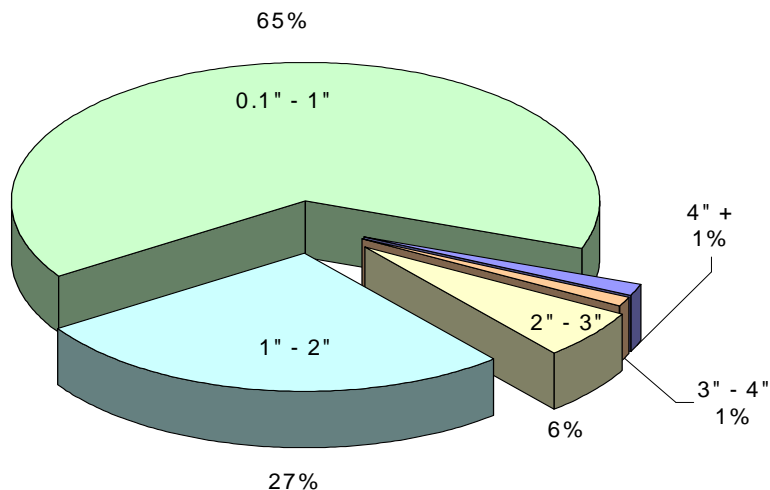


Figure 2-9. Distribution of precipitation by storm magnitude for Harrisburg, PA (Original Data from Penn State Climatological Office, 1926-2003)

Stormwater management has historically focused on managing flooding from the larger but less frequent extreme event storms (Table 2-1). Traditional site design has focused on the **peak rate** of runoff during such events; that is, how fast the stormwater runoff is leaving the site after

development. Detention facilities are built to slow down the rate of runoff leaving a site during large storms so that the rate of runoff after development is not greater than the rate before development. Regulatory criteria is often based on controlling the “release” rate of runoff from the 2-year through 100-year storm events. Storm frequency is based on the statistical probability of a storm being exceeded in any year. That is, a 2-year storm has a 50% probability of being exceeded in any single year, and a 100-year storm, a 1% probability.

Table 2-1. Statistical Storm Frequency Events for locations in PA (24 hour duration) (Source: NOAA National Weather Service Precipitation Frequency Data Server, 2004).

Location	Frequency of Occurrence (Years)				
	2-year	5-year	10-year	50-year	100-year
Philadelphia	3.3	4.1	4.8	6.7	7.6
Pittsburgh	2.4	2.9	3.3	4.4	4.9
Scranton	2.6	3.2	3.7	5.4	6.4
State College	2.7	3.3	3.8	5.2	5.9
Williamsport	2.8	3.5	4.1	6.0	7.0
Erie	2.6	3.2	3.7	5.1	5.8

Preventing increased runoff rates from large storm events is extremely important but it does not do enough to protect streams and water quality. With a change in land surface, not only does the peak **rate** of runoff increase, the **volume of** runoff also increases. While a stormwater detention facility may slow the rate of runoff leaving a site, there may still be an increased volume of runoff. This is shown graphically in Figure 2-10. Detention controls the peak runoff rate by extending the hydrograph. So while the rate of runoff may not increase, the duration of runoff will be longer than before development because of the increased volume.

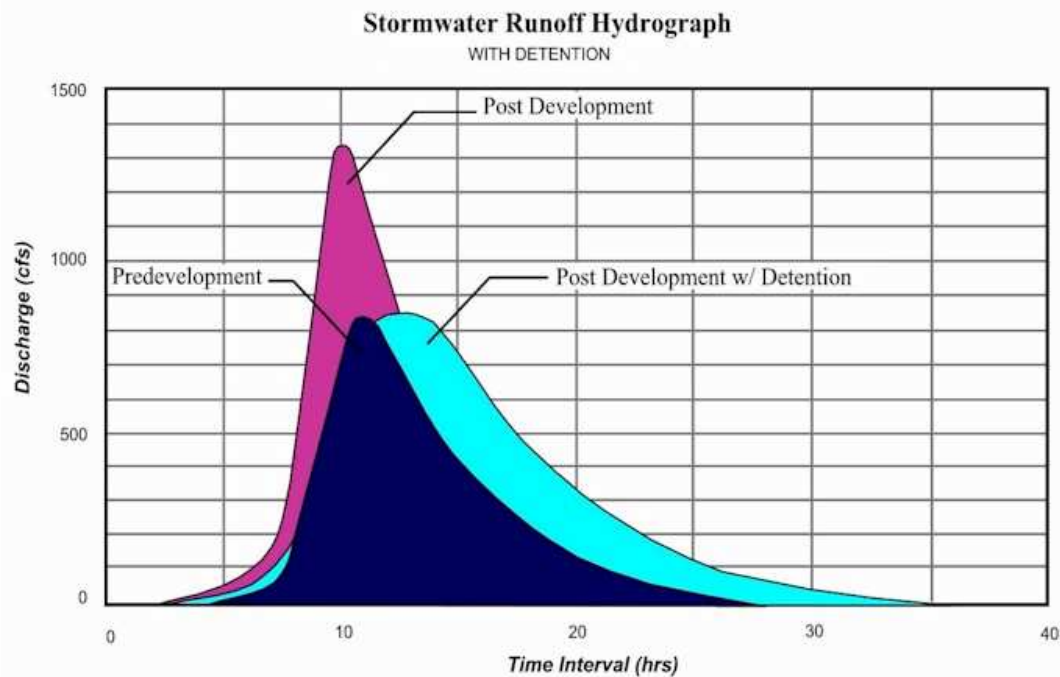


Figure 2-10. The hydrograph is an important tool used for understanding the hydrologic response of a given rainfall event. The area beneath the hydrograph curve represents the total volume of runoff being discharged.



On a watershed basis, detention becomes ineffective downstream as the sole management strategy for stormwater control due to the extended hydrograph and increased volume. There is even a possibility that the peak flows may **increase** downstream flooding. The combination of more runoff volume over a longer time period will result in downstream flow rates that are higher than before development, as indicated in Figure 2-11.

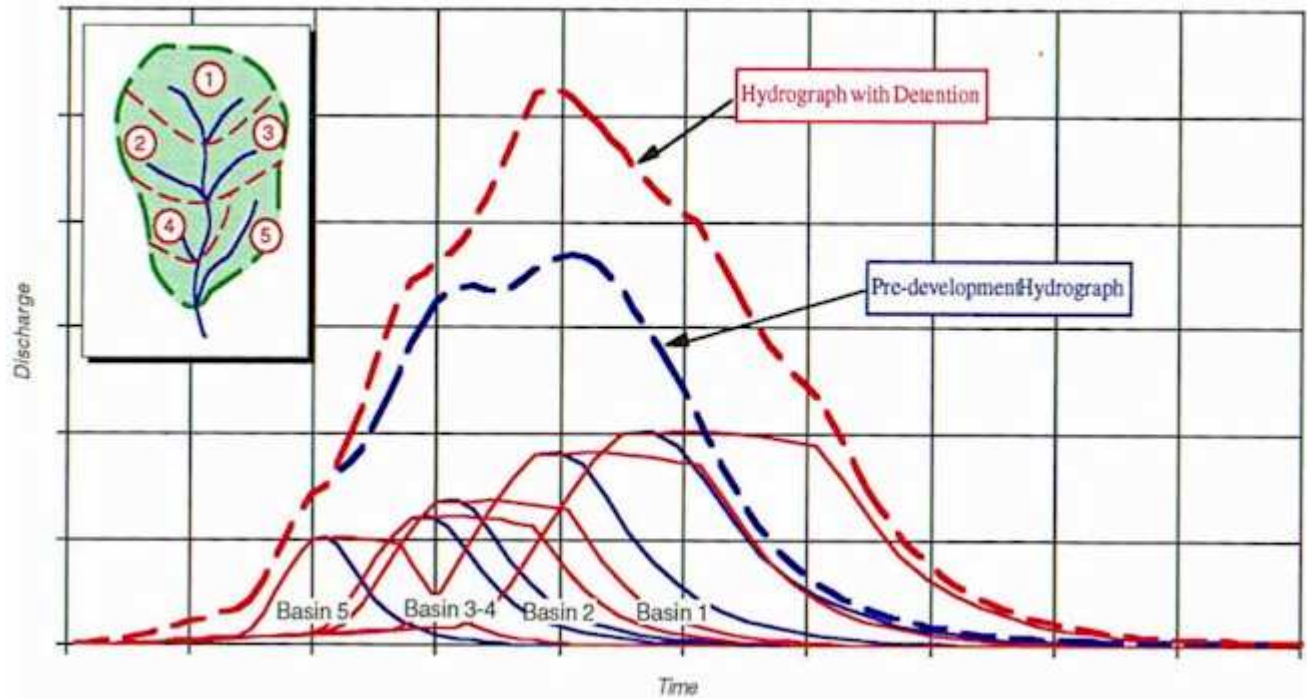


Figure 2-11. This figure illustrates a small watershed comprised of five hypothetical Subbasin development sites, 1 through 5, each of which undergoes development and relies on a separate peak rate control detention basin. As the storm occurs, five different hydrographs result for each sub-area and combine to create a resultant pre-development hydrograph for the overall watershed. The net result of the combined hydrographs is that the watershed peak rate increases considerably, because of the way in which these increased volumes are routed through the watershed system and combine downstream. Flooding increases considerably in peak and duration, even though these detention facilities have been installed at each individual development.

The second reason that detention alone is not sufficient for stormwater management is that it does not address the frequent small storm events in Pennsylvania. Most of the rainfall in Pennsylvania occurs in relatively small storm events, as indicated for the Harrisburg area (Figure 2-9). In Harrisburg, over half of the average annual rainfall occurs in storms of less than 1 inch (in 24 hours). Over 90 percent of the average annual rainfall occurs in storms of 2 inches or less, and over 95 percent of average annual rainfall occurs in storms of 3 inches or less. This pattern is typical of the entire state.

Detention facilities that are designed to control the peak flow rate for large storm events often allow frequent small storm events to “pass through” the detention facility. These small frequent rainfall events discharge from the site at a higher rate and a greater volume of runoff than before development. There is also an increase in the **frequency** of runoff events because of the change

in land surface. For example, little runoff will occur from most wooded sites until over an inch of rainfall has fallen. In contrast, a paved site will generate runoff almost immediately (Figure 2-12). After development, runoff will occur with greater frequency than before development, and runoff may be observed with every rainfall. The design of stormwater systems that collect, convey and concentrate runoff may further degrade conditions.

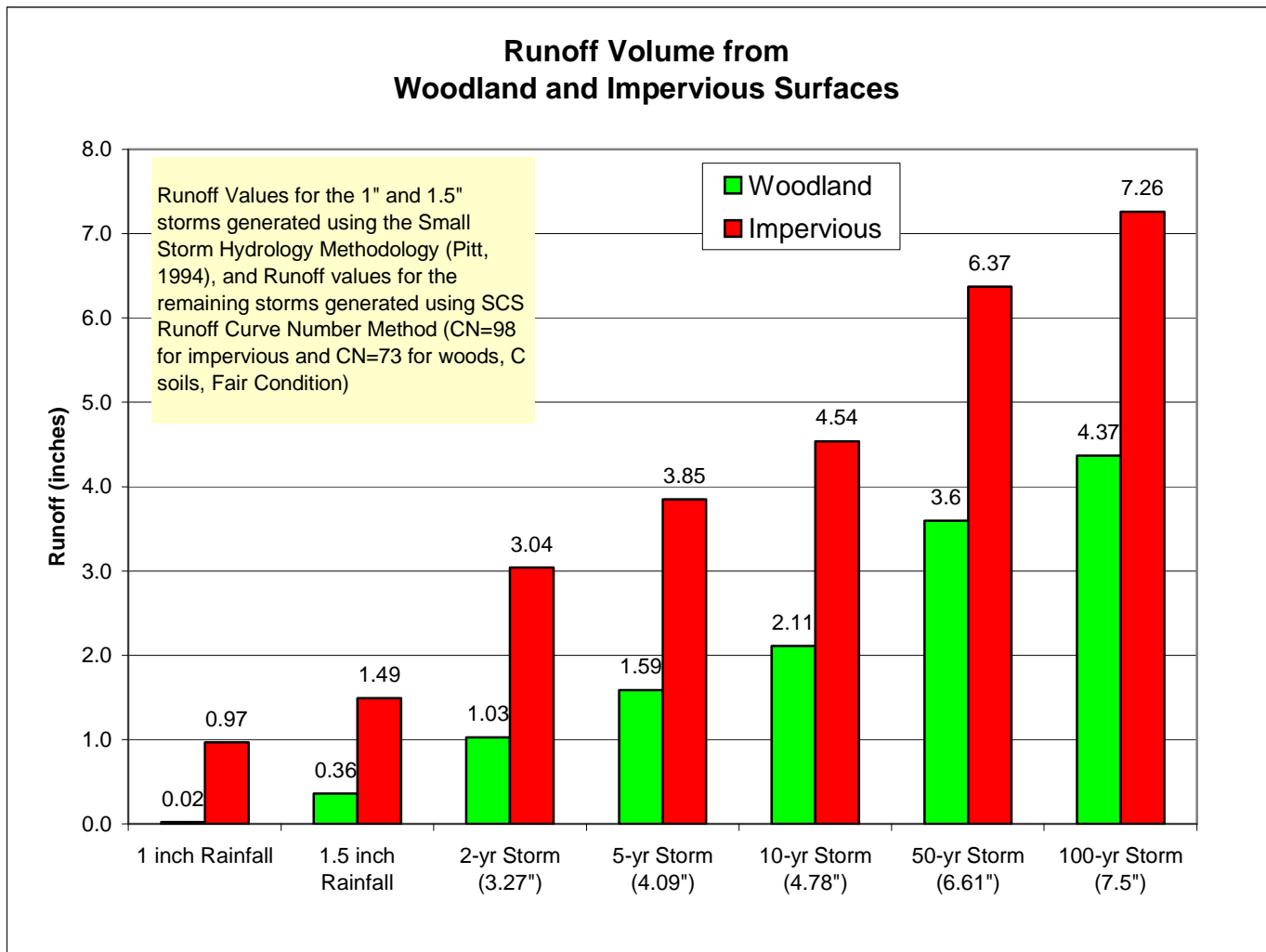


Figure 2-12. This graph generally compares the volume of runoff generated from a woodland site with the volume of runoff generated by impervious area for different rainfall amounts. Note that the volume increase for small storms is significant.

The combination of more runoff, more often and at higher rates will create localized flooding and damage even in small storm events. Throughout the state, over 95 percent of the annual rainfall volume occurs in storm events that are less than the 2-year storm event. The net effect is that during most rainfall events, stormwater discharges are not managed or controlled, even with numerous detention basins in place.

### 2.2.2 The Impacts of Vegetation Loss and Soil Changes

On woodland and meadow areas, over half of the average annual rainfall returns to the atmosphere through evaporation and transpiration (Figure 2-6). The vegetation itself also intercepts and slows the rainfall, reducing its erosive energy, reducing overland flow of runoff, and allowing infiltration to occur. The root systems of plants also provide pathways for downward water movement into the soil mantle.

Evapotranspiration (ET) varies tremendously with season and with type of vegetative cover. Trees can effectively evapotranspire most, if not all, of the precipitation, that falls in summer rain showers. Evapotranspiration dramatically declines during the winter season. During these periods, more precipitation infiltrates and moves through the root zone, and the groundwater level rises. Removing vegetation or changing the land type from woods and meadow to residential lawns reduces evapotranspiration and increases the amount of stormwater runoff.

Soil disturbance and compaction also increases stormwater runoff. Soils contain many small openings called “macropores” that provide a mechanism for water to move through the soil, especially under saturated conditions. When soil is disturbed (grading, stockpiling, heavy equipment traffic, etc.) the soil is compacted, macropores are smashed and the natural soil structure is altered. Soil permeability characteristics are substantially reduced.

Compaction can be measured by determining the bulk density of the soil. The more compacted the soil is, the heavier it is by volume.

**Table 2-2. Common Bulk Density Measurements**

<b>Undisturbed Lands Forest &amp; Woodlands 1.03 g/cc</b>	<b>Residential Neighborhoods 1.69 to 1.97 g/cc</b>
<b>Golf Courses - Parks Athletic Fields 1.69 to 1.97 g/cc</b>	<b>CONCRETE 2.2 g/cc</b>

Heavy construction equipment can compact soil so significantly that the soil bulk density of lawn soil approaches the bulk density of concrete (Table 2-2 Ocean County, New Jersey Soil Conservation District, 2001; Hanks and Lewandowski, 2003). The result is a surface that is functionally impervious because the water absorbing capacity of the soil is so altered and reduced.

As discussed in Chapters 5 and 6, comprehensive stormwater management focuses on preventing an increase in stormwater runoff volume by protecting vegetation and soils, or minimizing stormwater impacts by restoring vegetation and soils to reduce runoff volumes and the velocity of runoff. Vegetation and soils are a critical component of the “water balance” and are an essential part of better stormwater management.

### 2.2.3 Groundwater Recharge, Stream Base Flow, and First-Order Streams

Water moves through the soil until it is evapotranspired or reaches the groundwater table and replenishes the aquifer. The actual movement of water through the sub-surface pathways is complex, and less permeable soils, clay layers, and rock strata are often encountered. The water moving through the soil is generally referred to as gravitational water or drainage water. Other types of water in soil include capillary water and hygroscopic water. Capillary water is that water held in soil pores by surface attraction (sometimes referred to as capillary action); this is the water that is typically available to plants for uptake. Hygroscopic water is water that is tightly held by the

soil particles and can only be removed by physical drying. Although capillary water does play an important role in evaporation processes, gravitational water is of primary concern from a stormwater management prospective.

The movement of gravitational water through the soil is influenced by a soils texture, structure, layering and the presence of preferential flow pathways (macropores). Soil textures are defined by the percentage of sand, silt and clay present in the soil. In general, the permeability and hydraulic conductivity of a soil will decrease with decreasing textural grain size (i.e., gravitational water moves more easily through sands than silts and clays). Soil texture also influences the shape of the wetting front as water moves through a soil.

It has also been observed that there is a discontinuity of soil-water movement at the interface between soils of different textures. This layering causes percolating water to concentrate at certain points along the layer interface and then break into the layer interface in finger-like protrusions. The significance is that even a change in soil texture within a vertical profile will cause a disruption in the soil-water movement. This disruption often causes water to “back up” at the interface, which can cause water to move laterally.

Soil structure also influences the movement of water through a soil. A disruption in the movement of soil water will occur at the interface between soil layers of differing structures. While texture and structure are certainly important to how water moves through soils, soil layering and the presence of dominant flow paths (macropores) play the most significant role in defining how water moves through the subsurface.

Soils form over time in response to their landscape position, climate, presence of organisms and parent material. Soils that have formed in place from the weathering of their parent material, usually form a typical profile with A, B and C horizons above bedrock. However, many soils form from a combination of the weathering of parent materials and the deposition of transported soils creating a more complex layering effect. In general, any interface between soil layers can slow the downward movements of water through a soil profile and promote lateral flow. This is especially true in sloping landscapes typical of most of Pennsylvania.

Restrictive soil layers within a soil profile also disrupt the vertical movement of soil-water and promote the lateral movement of water through the soil. Restrictive soil layers include clay lenses, fragipans or plow pans, for example. Fragipans are layers within a soil profile that have been compressed as a result of some external influence (glaciation for example). This compressed layer often causes water to perch above the fragipan and promotes lateral flow. Fragipans are commonly found in colluvial and glacial soils. In addition, many soils in agricultural regions of Pennsylvania contain “plow-pans” which are compressed layers of soil formed by the repeated traversing by moldboard plows.

Soil water also follows preferential flow paths through the soil. Preferential flow paths include pathways created by plant roots, worm or rodent burrows, cracks or voids in the soil resulting from piping action caused by the lateral movement of soil-water. Preferential flow paths also form at the soil rock interface and within rock structures.

The groundwater level rises and falls depending on the amount of rainfall/snowmelt and the time of year. The water cycle illustration of Figure 2-6 estimates that approximately 12 inches of the 45 inches of average annual precipitation in this natural watershed system finds its way into the groundwater table.

A variety of processes can occur when precipitation falls on a natural soil surface. Hillslope hydrology processes have been identified by Chorley (1978) and are systematically illustrated in Figure 2-12. The flow processes illustrated here are only representative examples of the complex interactions that occur in nature. Simplified descriptions of these processes follow:

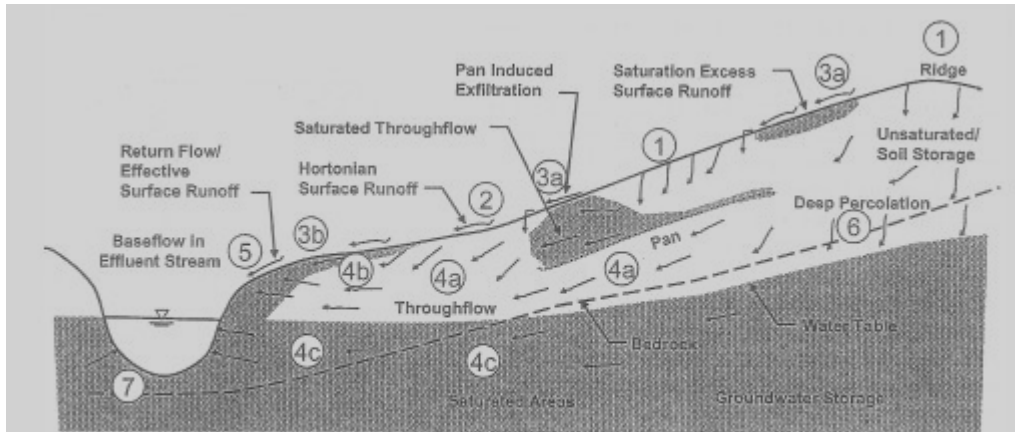


Figure 2-12 Components of hillslope hydrology (Adapted from Chorley [1978])

1. Areas marked with a “1” are areas where the infiltration capacity of the soils exceeds the rainfall rate. All rain falling on these areas infiltrates into the ground.
2. Areas labeled with a “2” identifies an area where the rainfall rate exceeds the surface infiltration rate, and the excess rainfall becomes surface runoff (Hortonian surface runoff).
3. Areas marked with a “3” represents areas where the soil has become saturated and cannot hold additional moisture; all rain falling on these areas immediately becomes surface runoff. Saturation can occur as a result of various subsurface conditions. Areas marked “3a” illustrates where a restricting layer (fragipans, clay lenses, etc.) limits the downward movement of soil water creating a perched water table that reaches the ground surface. Area “3b” identifies an area where water moving through the soil (through-flow) reaches the surface as a spring or seep (return-flow); in these cases the surface in the vicinity of the seep or spring becomes saturated.
4. The areas marked with a “4” represent areas of through-flow. Through-flow is the lateral movement of water through the soil. Area “4a” illustrates through-flow along preferential flow paths in unsaturated soils; area “4b” shows shallow surface flow (a common occurrence in PA); and area “4c” illustrates through-flow in saturated areas.
5. Areas marked with a “5” represents an area of return-flow. Return-flow is water that has moved through unsaturated or saturated subsurface areas and re-appears as surface flow through springs or seeps.
6. The area labeled as “6” represents an area of deep percolation or groundwater recharge.
7. Area “7” points to a location where groundwater discharges to the stream (influent streams). For effluent streams, water moves from the stream into the ground water table in these areas. In some streams, both processes may occur during different times of the year. (Brown/Fennessey/Petersen)

Most of these flow processes occur within natural watersheds in Pennsylvania. The extent to which one or more of these processes are active within a particular area is influenced by soil characteristics, geology and topography or landscape position.

Eventually the groundwater table intersects the land surface and forms springs, first order streams and wetlands (Figure 2-5). This groundwater discharge becomes stream base flow and occurs continuously, during both wet and dry periods. Much of the time, all of the natural flow in a stream is from groundwater discharge. In this sense, groundwater discharge can be seen as the “life” of streams, supporting all water-dependent uses and aquatic habitat. First-order streams are defined as “that stream where the smallest continuous surface flow occurs” (Horton, 1945), and are the beginning of the aquatic food chain that evolves and progresses downstream (Figure 2-13). As the link between groundwater and surface water, headwaters represent the critical intersection between terrestrial and aquatic ecosystems. During periods of wet weather, the water table may rise to near the ground surface in the vicinity of the stream. This higher ground water table coupled with through-flow, return-flow and shallow subsurface flow result in an area of saturation in the vicinity of the stream channel. As a result, this area saturates quickly during rain events; and the larger the rain event, the more extensive the area of saturation may be. It is understood by researchers that a significant amount of the surface runoff observed in streams during precipitation events is generated from the saturated areas surrounding streams (Chorley, 1978; Hewlett and Hibbert, 1967). The runoff generated from rainfall on saturated land areas is referred to as saturation overland flow. Hydrologists understand that the watershed runoff process is a complex integration of saturation overland flow and infiltration excess (Hortonian) overland flow (Troendle, 1985). Areas that generate surface runoff pulsate, shrink and expand in response to rainfall. This concept on a watershed scale is consistent with the hillslope hydrologic processes.



*Figure 2-13 Leaves and organic matter are initially broken down by bacteria and processed into food for higher organisms downstream.*

Changes in land use cause runoff volumes to increase and groundwater recharge to decrease. Wetlands and first order streams reflect changes in groundwater levels most profoundly, and this reduced flow can stress or even eliminate the aquatic community. As the most hydrologically and biologically sensitive elements of the drainage network, headwaters and first order streams warrant special consideration and protection in stormwater management.

### 2.2.4 Stream Channel Changes

The shape of a stream channel, its width, depth, slope, and how it moves through the landscape, is influenced by the amount of flow the stream channel is expected to carry. The stream channel morphology is determined by the energy of stream flows that range from “low flow” to “bank full”. The flow depths determine the energy in the stream channel, and this energy shapes the channel itself. In an undeveloped watershed, bank full flow occurs with a frequency of approximately once every 18 months. During larger flood events, the flow overtops the stream banks and flows into the floodplain with much less impact on the shape of the stream channel itself.

In a developing watershed, the volume and rate of stormwater runoff increase during small storm events and the stream channel changes to accommodate the greater flows. Because the stream is conveying greater flows more often and for longer periods of time, the stream will try to accommodate these larger flows by eroding stream banks or cutting down the channel bottom. Since traditional detention basins do not manage small storms, these impacts are often most pronounced downstream of detention basins.

Numerous studies have documented the link between altered stream channels and land development. The Center for Watershed Protection (Article 19, Technical Note 115, Watershed Protection Techniques 3(3): 729-734) states that land development influences both the geometry (morphology) and stability of stream channels, causing downstream channels to enlarge through widening and stream bank erosion. These physical changes, in turn, degrade stream habitat and produce substantial increases in sediment loads resulting from accelerated channel erosion.

As the shape of the stream channel changes to accommodate more runoff, aquatic habitat is often lost or altered, and aquatic species decline. Studies, such as US EPA's *Urbanization and Streams: Studies of Hydrologic Impacts* (1997), conclude that land development is likely to be responsible for dramatic declines in aquatic life observed in developing watersheds. These stream channel impacts have been observed even where conventional stormwater management is applied.

The effects occur at many levels in the aquatic community. As the gravel stream bottom is covered in sediment, the amount and types of microorganisms that live along the stream bottom decline. The stream receives sediment from runoff, but additional sediment is generated as the stream banks are eroded and this material is deposited along the stream bottom. Pools and riffles important to fish and other aquatic life are lost, and the number and types of fish and aquatic insects diminishes. Trees and shrubs along the banks are undercut and lost, removing important habitat and decreasing natural shading and cooling for the stream.

The runoff from impervious surfaces is usually warmer than the stream flow, and can harm the aquatic community. When the stream flow is comprised primarily of groundwater discharge, the constant, cool temperature of the groundwater buffers the stream temperature. As the flow of groundwater decreases and the amount of surface runoff increases, the temperature regime of the stream changes. Runoff from impervious surfaces in the summer months can be much hotter than the stream temperature, and in the winter months this same runoff can be colder. These changes in temperature dramatically affect the aquatic habitat in the stream, ranging from the fish community that the stream can support to the microorganisms that form the foundation of the food chain. Important fungal communities can be lost altogether. It is apparent that increasing impervious areas can lead to significant degradation of surface water by altering the entire aquatic ecosystem.

### **2.2.5 Water Quality**

Impervious surfaces and maintained landscapes generate pollutants that are conveyed in runoff and discharged to surface waters. Many studies of pollutant transport in stormwater have documented that pollutant concentrations show a distinct increase at the beginning of a flow hydrograph referred to as the "first flush". In fact, the particulate associated pollutants that are initially scoured from the land surface and suspended in the runoff are observed in a stream or river before the runoff peak occurs. These pollutants include sediment, phosphorus that is moving with colloids (clay particles), metals, and organic particles and litter. Dissolved pollutants, however,

may actually decrease in concentration during heavy runoff. These include nitrate, salts and some synthetic organic compounds applied to the land for a variety of purposes.

Managing stormwater to minimize pollutant loading includes reducing the sources of these pollutants as well as restoring and protecting the natural systems that are able to remove pollutants. These include stream buffers, vegetated systems, and the natural soil mantle, all of which can be put to use to remove pollutants from stormwater runoff.

**Stormwater quantity and quality are inextricably linked and need to be managed together.**

Although the most obvious impact of land development is the increased rate and volume of surface runoff, the pollutants transported with this runoff comprise an equally significant impact. Management strategies that address quantity will in most cases address quality.

**Stormwater runoff pollutants include sediment, organic detritus, phosphorus and nitrogen forms, metals, hydrocarbons, and synthetic organics.** The increased stormwater runoff brought on by land development scours both impervious and pervious land surfaces. Stormwater runoff transports suspended and dissolved pollutants that were initially deposited on the land surface. Hot spot impervious areas such as fueling islands, trash dumpsters, industrial sites, fast food parking lots, and heavily traveled roadways contribute heavy pollutant loads to stormwater.

Many so-called pervious surfaces, such as the chemically maintained lawns and landscaped areas, also add significantly to the pollutant load, especially where these pervious areas drain to impervious surfaces, gutters and storm sewers. The soil compaction process applied to many land development sites results in a vegetated surface that is close to impervious in many instances, and produces far more runoff than the pre-development soil did. These new lawn surfaces are often loaded with fertilizers that result in polluted runoff that degrades all downstream ponds and lakes.

**The two physical forms of stormwater pollutants are particulates and solutes.** One very important distinction for stormwater pollutants is the extent to which pollutants are particulate in form, or dissolved in the runoff as solutes. The best example of this comparison is the two common fertilizers: Total phosphorus (TP) and nitrate (NO<sub>3</sub>-N). Phosphorus typically occurs in particulate form, usually bound to colloidal soil particles. Because of this physical form, stormwater management practices that rely on physical filtering and/or settling out of sediment particles can be quite successful for phosphorus removal. In stark contrast, nitrate tends to occur in highly soluble forms, and is unaffected by many of the structural BMPs designed to eliminate suspended pollutants. As a consequence, stormwater management BMPs for nitrate may be quite different than those used for phosphorous removal. Non-Structural BMPs (Chapter 5) may in fact be the best approach for nitrate reduction in runoff.

**Particulates:** Stormwater pollutants that move in association with or attached to particles include total suspended solids (TSS), total phosphorus (TP), most organic matter (as estimated by COD), metals, and some herbicides and pesticides. Kinetic energy keeps particulates in suspension and some do not settle out as easily. For example, an extended detention basin offers a good method to reduce total suspended solids, but is less successful with TP, because much of the TP load is attached to fine clay particles that may take longer to settle out.

If the concentration of particulate-associated pollutants in stormwater runoff, such as TSS and TP, is measured in the field during a storm event, a significant increase in pollutant concentration corresponding to but not synchronous with the surface runoff hydrograph is usually observed (Figure 2-14). This change in pollutant concentration is referred to as a “chemograph”, and has contributed to the concept of a “first flush” of stormwater pollutants. In fact, the actual transport



process of stormwater pollutants is somewhat more complex than “first flush” would indicate, and has been the subject of numerous technical papers (Cahill et al, 1974: 1975; 1976; 1980; Pitt, 1985, 2002). To accurately measure the total mass of stormwater pollution transported during a given storm event, both volume and concentration must be measured simultaneously, and a double integration performed to estimate the mass conveyed in a given event. To fully develop a stormwater pollutant load for a watershed, a number of storm events must be measured over several years. The dry weather chemistry is seldom indicative of the expected wet weather concentrations, which can be two or three orders of magnitude greater.

Because a major fraction of particulate associated pollutants is transported with the smallest particles, or colloids, their removal by BMPs is especially difficult. These colloids are so small that they do not settle out in a quiescent pool or basin, and remain in suspension for days at a time, passing through a detention basin with the outlet discharge. It is possible to add chemicals to a detention basin to coagulate these colloids to promote settling, but this chemical use turns a natural stream channel or pond into a treatment unit, and subsequent removal of sludge is required. A variety of BMPs have been developed that serve as runoff filters, and are designed for installation in storm sewer elements, such as inlets, manholes or boxes. The potential problem with all measures that attempt to filter stormwater is that they quickly become clogged, especially during a major event. Of course, one could argue that if the filter systems become clogged, they are performing efficiently, and removing this particulate material from the runoff. The major problem then with all filtering (and to some extent settling) measures is that they require substantial maintenance. The more numerous and distributed within the built conveyance system that these BMPs are situated, the greater the removal efficiency, but also the greater the cost for operation and maintenance.

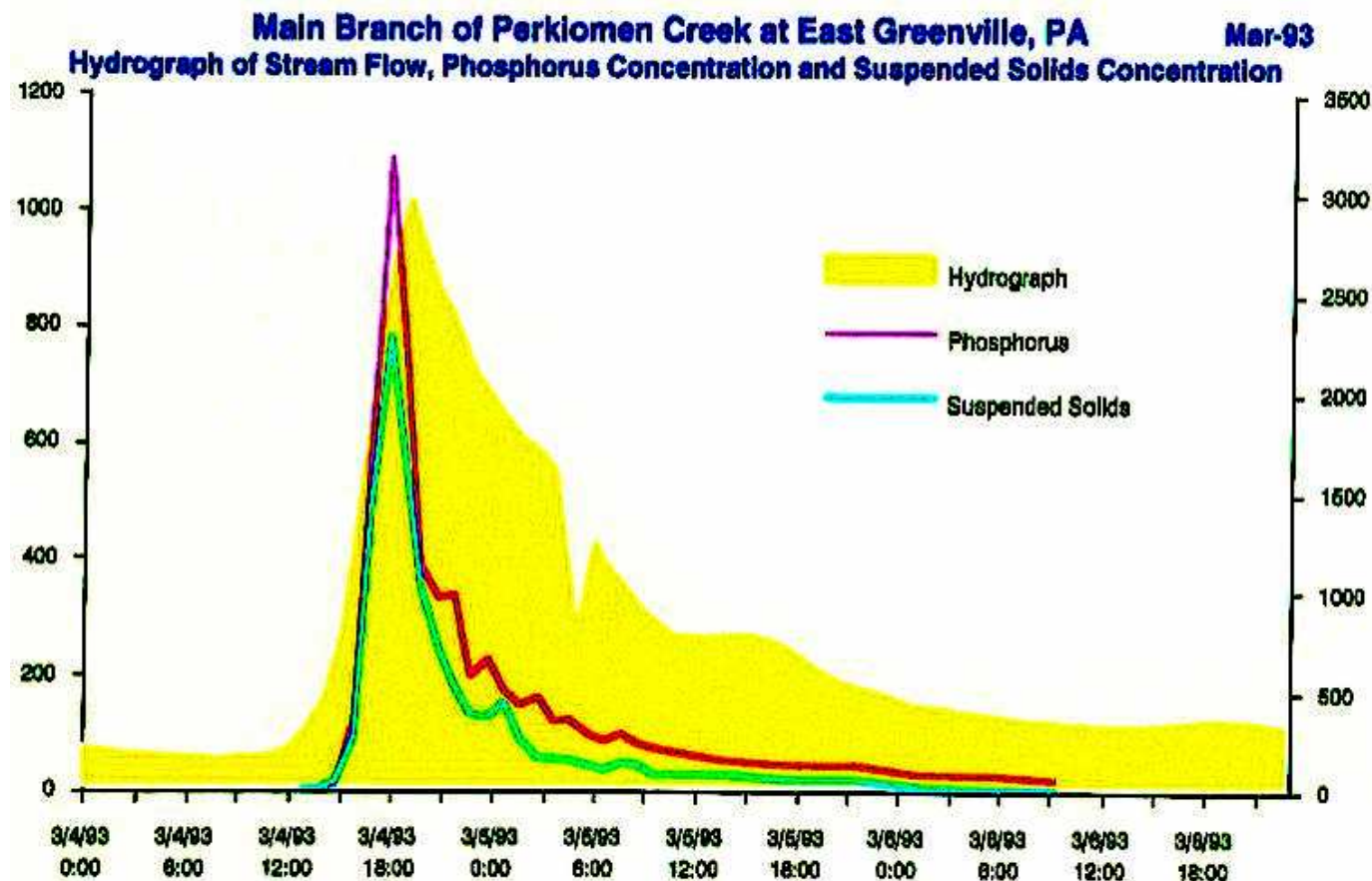


Figure 2-14. Chemograph of phosphorus and suspended solids in Perkiomen Creek (Cahill, 1993).

**Solutes:** Dissolved stormwater pollutants generally do not exhibit any increase during storm event runoff, and in fact may exhibit a slight dilution over a given storm hydrograph. Dissolved stormwater pollutants include nitrate, ammonia, salts, organic chemicals, many pesticides and herbicides, and petroleum hydrocarbons (although portions of the hydrocarbons may bind to particulates and be transported with TSS). Regardless, the total mass transport of soluble pollutants is dramatically greater during runoff because of the volume increase. In some watersheds, the stormwater transport of soluble pollutants can represent a major portion of the total annual discharge for a given pollutant, even though the absolute concentration remains relatively constant. For these soluble pollutants, dry weather sampling can be very useful, and often reflects a steady concentration of soluble pollutants that will be representative of high flow periods.

Some dissolved stormwater pollutants can be found in the initial rainfall, especially in regions with significant emissions from fossil fuel plants. Precipitation serves as a “scrubber” for the atmosphere, removing both fine particulates and gases (NO<sub>x</sub> and SO<sub>x</sub>). Chesapeake Bay scientists have measured rainfall with NO<sub>3</sub> concentrations of 1 to 2 mg/l, which could comprise a significant fraction of the total input to the Bay. Other rainfall studies by NOAA and USGS have resulted in similar conclusions. Impervious pavements can transport nitrate load, reflecting a mix of deposited sediment, vegetation, animal wastes, and human detritus of many different forms.

Pollution prevention through use of Non-Structural BMPs is very effective. A variety of Structural BMPs, including settling, filtration, biological transformation and uptake, and chemical processes

can also be used. Stormwater related pollution can be reduced if not eliminated through preventive Non-Structural BMPs (Chapter 5), but not all stormwater pollution can be avoided. Many of the Structural BMPs (Chapter 6) employ natural pollutant removal processes as essential elements. These “natural” processes tend to be associated with and rely upon both the existing vegetation and soil mantle. Thus preventing and minimizing disturbance of site vegetation and soils is essential to successful stormwater management.

**Settling:** Particles remain suspended in stormwater as long as the energy of the moving water is greater than the pull of gravity. In a natural stream, the stormwater that overflows the banks slows and is temporarily stored in the floodplain, which allows for sediment settling, and the building of the alluvium soils that comprise this floodplain. As runoff passes through any type of man-made structure, such as a detention basin, the same process takes place, although not as efficiently as in a natural floodplain. Where it is possible to create micro versions of runoff ponds (rain gardens), distributed throughout a site, the same settling effect will result. The major issue with settling processes is that the dissolved pollutant load is not subject to gravitational settling.

**Filtration:** Another natural process is physical filtration. Filtration through vegetation and soil is by far the most efficient way to remove suspended stormwater pollutants. Suspended particles are physically filtered from stormwater as it flows through vegetation and percolates into the soil. Runoff that is concentrated in swales, however, can exceed the ability of the vegetation to remove particles. Therefore, it is important to avoid concentrated flows by slowing and distributing the runoff over a broad vegetated area.

Stormwater flow through a relatively narrow natural riparian buffer of trees and herbaceous understory growth has been demonstrated to physically filter surprisingly large proportions of larger particulate-form stormwater pollutants. Both filter strip and grassed swale BMPs rely very much on this surface filtration process as discussed in Chapter 6.

**Biological Transformation and Uptake/Utilization:** This category includes an array of different processes that reflect the remarkable complexity of different surface vegetative types, their varying root systems, and their different needs and rates of transformation and utilization of different “pollutants,” especially nutrients. An equally vast and complex community of microorganisms exists below the surface within the soil mantle, and though more micro in scale, the myriad of natural processes occurring within this soil realm is just as remarkable.

Phosphorus and nitrate are essential to plant growth and therefore are taken up through the root systems of grasses, shrubs and trees. Nitrogen transformations are quite complex, but the muck bottom of wetlands allows the important process of denitrification to occur and convert nitrates for release in gaseous form. Nitrates in stormwater runoff passing through wetlands is removed and used by wetland plants to build biomass. The caution in terms of a wetland or similar surface BMP is that if the vegetation dies at the end of a growing season and the detritus is discharged from the wetland, the net removal of nitrate is maybe less than expected. The guidance for BMP applications is that if biological transformation processes are considered, care must be taken to remove and dispose of the biomass produced in the process.

**Chemical Processes:** Various chemical processes occur in the soil to remove pollutants from stormwater. These include adsorption through ion exchange and chemical precipitation. Cation Exchange Capacity (CEC) is a rating given to soil, that relates the soil organic content to its ability to remove pollutants as stormwater infiltrates through the soil. Adsorption will increase as the total surface area of soil particles and/or the amount of decomposed organic material increases. Clay soils have better pollutant reduction performance than sandy soils, and their slower permeability

rate has a positive effect. CEC values typically range from 2 to 60 milli-equivalents (meq) per 100 grams of soil. Coarse sandy soils have low CEC values and therefore are not especially good stormwater pollutant removers. The addition of compost will greatly increase the CEC of sandy soils. A value of 10 meq. is often considered necessary to accomplish a reasonable degree of pollutant removal.

### Section 2.3 References

Amandes, C. and Bedient, P., 1980, *Stormwater Detention in Developing Watersheds*, ASCE Journal of Hydraulics

Barnes, J. H., and W. D. Sevon, 1996. *The Geologic Story of Pennsylvania*, PA. Geological Survey, Educational Series No. 4, Harrisburg, PA

Brown, Scott A., P.E., Larry A.J.Fennessey, Ph.D.,P.E., and Gary W. Petersen,Ph.D., CPSS *Understanding Hydrologic Process for Better Stormwater Management*

Cahill, T. H., 1989. *The Use of Porous Paving for Groundwater Recharge in Stormwater Management Systems*. Floodplain/Stormwater Management Symposium, State College, PA, Oct., 1988.

Cahill, T. H., 1993. *Stormwater Management Systems, Porous Pavement System with Underground Recharge Systems, Engineering Design Report*, Spring, 1993.

Cahill, 1997. *Land Use Impacts on Water Quality: Stormwater Runoff*. T. H. Cahill, Chesapeake Bay Restoration and Protection: Townships in the Lead, Ches. Bay Local Govt. Adv. Comm., PA Assn of Twp Supv., Hbg., PA, Apr. 28, 1997.

Cahill, 1996. *Sustainable Watershed Management: Balancing Water Resources and Land Use*. W.R. Horner, T.H. Cahill and J. McGuire, Hydrology and Hydrogeology of Urban and Urbanizing Areas, Cahill Associates, West Chester, PA, April 21-24, 1996.

Cahill, et al., 1996. *Sustainable Watershed Management in Developing Watershed*. T. H. Cahill, J. McGuire, W. R. Horner, Cahill Assoc., West Chester, PA Am. Environment Congress, Anaheim, CA June 22-28, 1996.

Cahill, et al., 1996. *Sustainable Watershed Management at the Rapidly Growing Urban Fringe*. T. H. Cahill, J. McGuire, W. R. Horner, and R. D. Heister, at Watershed, 96, Balt. Conv. Ctr., Balt., MD. June 8-12, 1996.

Cahill, 1992. *Limiting Nonpoint Source Pollution from New Development in the New Jersey Coastal Zone: Summary*. T.H. Cahill, W.R. Horner, J.S. McGuire, and C. Smith, NJDEP; S. Whitney and S. Halsey, Cahill Assoc., West Chester, PA, September, 1992.

Cahill, 1992. *Structural and Nonstructural Best Management Practices for the Management of Non-Point Source Pollution in Coastal Waters: A Cost-Effectiveness*

*Comparison*. T.H. Cahill and W.R. Horner, The Coastal Society; Thirteenth International Conference: Conference Proceedings Organizing for the Coast, Washington, D.C., April 1992.

Chorley, R.J. (1978). *The hillslope hydrologic cycle*, Hillslope Hydrology, Edited by M.J. Kirby, Wiley, New York, NY, pp. 1-42

CWP, 2003. *Impacts of Impervious Cover on Aquatic Systems*, Center for Watershed Protection, Ellicott City, MD

Emerson, C., Welty, C., Traver, R., 2005, *A Watershed—scale Evaluation of a System of Stormwater Detention Basins*, ASCE Journal of Hydraulic Engineering

Fenneman, N. M., 1938. Physiography of Eastern United States, McGraw-Hill Book Co., New York, NY.

Fennessey, Lawrence A.J., Ph.D., P.E. and Arthur C. Miller, Ph.D., P.E. 2001. *Hydrologic Processes During Non-Extreme Events in Humid Regions*

Fennessey, Lawrence A.J., Ph.D., P.E. and Richard H. Hawkins, Ph.D., P.E. 2001. *The NRCS Curve Number, a New Look at an Old Tool*

Friedman, D.B., 2001. "Impact of Soil Disturbance During Construction on Bulk Density and Infiltration in Ocean County, New Jersey." Ocean County Soil Conservation District. Forked River, NJ

Friedman, D.B., "Developing an Effective Soil Management Strategy." Ocean County Soil Conservation District. Forked River, NJ.

Godfrey, M. A., 1997. *Field Guide to the Piedmont*, The University of North Carolina Press, Chapel Hill, NC.

Hanks, D & A. Lewandowski, 2003. *Protecting Urban Soil Quality: Examples for Landscape Codes and Specifications*, USDA-NRCS, Toms River, NJ

Hewlett, J.D., and A.R. Hibbert (1967). *Factors Affecting the Response of Small Watersheds to Precipitation in Humid Areas*, Forest Hydrology, Pergamon Oxford, pp. 275-290

Konrad, C. P. & D. B. Booth, 2002. *Hydrologic Trends Associated with Urban Development for Selected Streams in the Puget Sound Basin, Western Washington*. USGS Water Resources Investigation Report 02-4040 with Washington Dept. of Ecology, Tacoma, Wash.

Kochanov, W. E., 1987. *Sinkholes and Related Karst Features Map of Lehigh County, PA*. PA Geologic Survey, Open File Report 8701, Harrisburg, PA

Kochanov, W. W., 1999. *Sinkholes in Pennsylvania*. PA Geological Survey, 4<sup>th</sup> Series, Educational Series 11, Harrisburg, PA

Linsley, et al., 1992. *Water Resources Engineering, 4<sup>th</sup> Edition*. .

Maryland Department of the Environment, 2000. *Maryland Stormwater Design Manual*.

McCandless, T. L. and R. A. Everett, 2002. *Maryland Stream Survey: Bankfull Discharge and Channel Characteristics of Streams in the Piedmont Hydrologic Region*, US Fish & Wildlife Service, CBFO –S02-01, Annapolis, MD

McCandless, T. L., 2003. *Maryland Stream Survey: Bankfull Discharge and Channel Characteristics of Streams in the Allegheny Plateau and the Valley and Ridge Hydrologic Regions*, US Fish & Wildlife Service, CBFO-S01-01, Annapolis, MD

McCuen, Richard, 1979, *Downstream Effects of Stormwater Management Basins*, ASCE Journal of Hydraulics

McCuen, R. and Moglen, G., 1988, *Multicriterion Stormwater Management Methods*, ASCE Journal of Hydraulics

NOAA, 2001. *Tropical Cyclones and Inland Flooding*, US Dept. of Commerce, Natl. Weather Service, Bohemia, NY

Ocean Co. SCD, 2001. *Impact of Soil Disturbance During Construction on Bulk Density and Infiltration in Ocean County, NJ*. Ocean Co. Soil Conserv. Dist., Schnabel Eng. Assoc., USDA-NRCS, Toms River, NJ

PADCNR, 2003. *Geologic Shaded Relief Map of Pennsylvania*, compiled by C. E. Miles, PA Dept. of Conservation and Natural Resources, Harrisburg, PA

Pitt, Robert, 1985, 2002

Roberts, D. C., 1996. *A Field Guide to the Geology of Eastern North America*, Peterson Field Guide, Houghton Mifflin, New York

Scotese, C. R., 1997. *Paleogeographic Atlas*, PALEOMAP Progress Report 90-0497, Dept. of Geology, Univ. of Texas at Arlington, TX

Sorvig, K., 1993. *Porous Paving*. Landscape Architecture, Vol. 83, No. 2, Feb., 1993. Wash., DC

Sloto, R. A., 1994. *Geology, Hydrology and Groundwater Quality of Chester County, Pennsylvania*, Chester Co. Water Resources Auth., w/USGS, West Chester, PA

Socolow, A. A., 1976. *Pennsylvania Geology Summarized*, Pa Dept. of Topographic and Geologic Survey, Ed. Series No. 4, Harrisburg, PA

Sauer, L. J., 1998. *The Once and Future Forest*, Island Press, Washington, DC

Troendle, C.A. (1985) *Variable Source Area Models, Hydrologic Forecasting*, M.G. Anderson and T.P. Burt (ed.) John Wiley, New York

Viessman, W. and G. Lewis, 2003. *Introduction to Hydrology*, 5<sup>th</sup> Edition, Pearson Educ., Ltd., Upper Saddle River, New Jersey

Whitney, G. G., 1994. *From Coastal Wilderness to Fruited Plain: A History of Environmental Change in Temperate North America from 1500 to the Present*, Cambridge Univ. Press, New York





---

# **Pennsylvania Stormwater Best Management Practices Manual**

---

## **Chapter 3**

### **Stormwater Management Principles and Recommended Control Guidelines**





**Chapter 3 Stormwater Management Principles and Recommended Control Guidelines**

**3.1 Introduction.....1**

**3.2 Recommended Site Control Guidelines.....1**

**3.3 Recommended Volume Control Guidelines.....2**

**3.3.1 Volume Control Criteria.....4**

**3.3.2 Volume Control Alternatives.....5**

**3.3.3 Control Guideline 1 (CG-1).....6**

**3.3.4 Control Guideline 2 (CG-2).....7**

**3.3.5 Retention and Detention Considerations.....7**

**3.4 Recommended Peak Rate Control Guideline.....8**

**3.5 Recommended Water Quality Control Guideline.....8**

**3.6 Stormwater Standards for Special Management Areas.....9**



### 3.1 Introduction

This Chapter provides guidance for municipalities striving to improve their stormwater management programs. It presents stormwater management principles and recommends site control guidelines to address volume, water quality and flow rate. These guidelines can serve as the basis for municipal stormwater regulation. Pennsylvania laws and regulations do not directly manage stormwater at the state level, although some state level management occurs through the Stormwater Management Act and the NPDES permitting program. All municipalities, regardless of their specific setting, are encouraged to enact the most comprehensive stormwater management ordinances possible. They should also work with their watershed neighbors to integrate their individual municipal actions within the watershed as a whole.

The guidelines established in this chapter reflect the ten basic principles of stormwater management presented in the forward. The principles are listed below once more to emphasize their fundamental importance as the foundation for the control guidelines that will follow.

1. Managing stormwater as a resource;
2. Preserving and utilizing existing natural features and systems;
3. Managing stormwater as close to the source as possible;
4. Sustaining the hydrologic balance of surface and ground water;
5. Disconnecting, decentralizing and distributing sources and discharges;
6. Slowing runoff down, and not speeding it up;
7. Preventing potential water quality and quantity problems;
8. Minimizing problems that cannot be avoided;
9. Integrating stormwater management into the initial site design process; and
10. Inspecting and maintaining all BMPs.

### 3.2 Recommended Site Control Guidelines

Site control guidelines are designed to meet water volume and water quality requirements and to follow the ten principles previously listed. The control guidelines presented in this Chapter are comprehensive and are consistent with the Pennsylvania Comprehensive Stormwater Management Policy, and are recommended to restore natural hydrology including velocity, current, cross-section, runoff volume, infiltration volume, and aquifer recharge volume. Following the guidelines will help sustain stream base flow and prevent increased frequency of damaging bank full flows. The guidelines also will help prevent increases in peak runoff rates for larger events (2-year through 100-year) on both a site-by-site and watershed basis. When applicable, Act 167 watershed plans may require additional rate controls to reduce cumulative flooding impacts downstream.

The site control guidelines are:

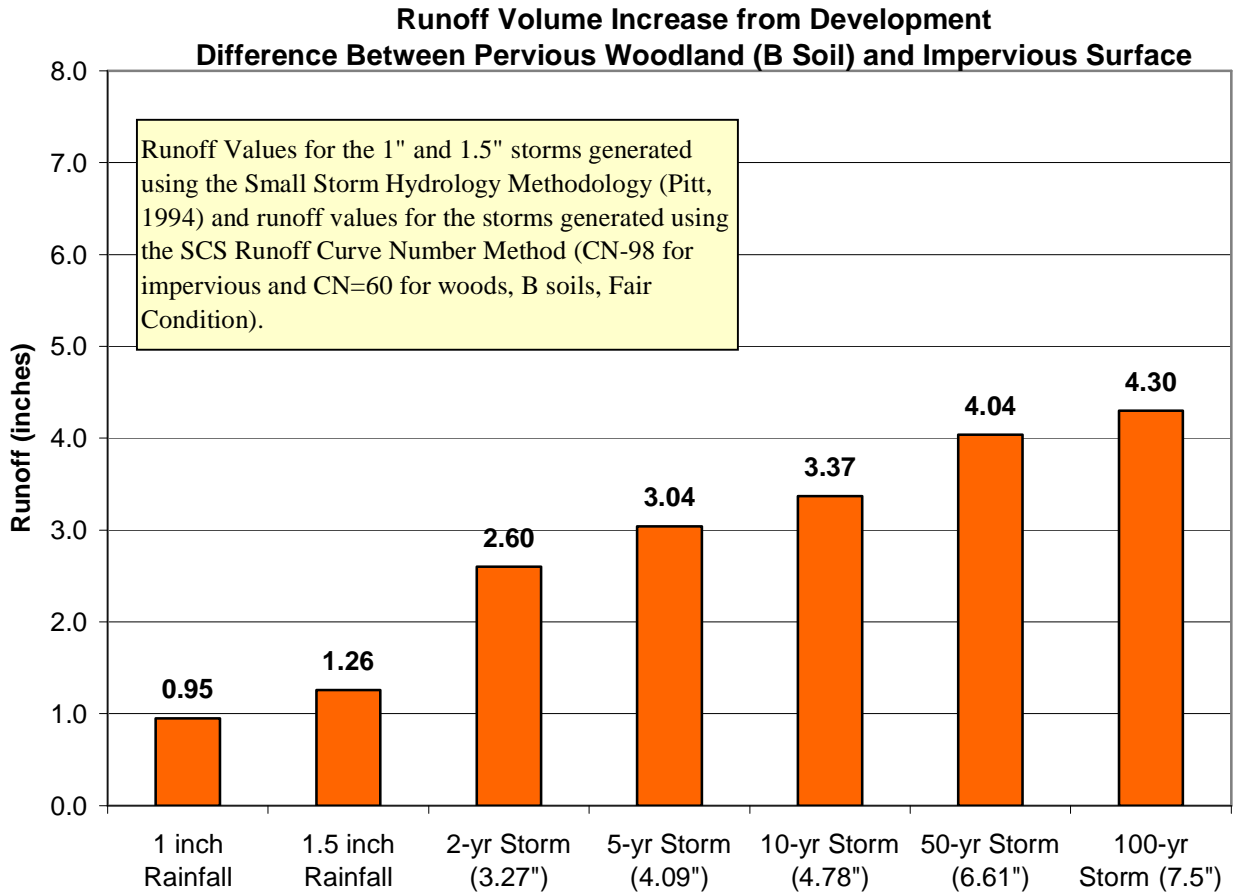
- **Effective** — The morphologic impacts on streams from increased volumes of runoff during smaller storms are prevented. The guidelines will be effective on a site-by-site basis, as well as on a broader watershed-wide scale;
- **Proportional** — The stormwater controls will produce approximately the same post-development stormwater discharge for all types of development in almost any location;

- **Equitable** — The requirements are based on project characteristics rather than project location so that physically similar projects will have similar storm water controls;
- **Flexible** — The diversity among Pennsylvania's 2,566 municipalities is accommodated by the guidelines. This diversity in physical conditions presents a major challenge that requires flexibility to achieve a uniform stormwater management program across the state.

### 3.3 Recommended Volume Control Guidelines

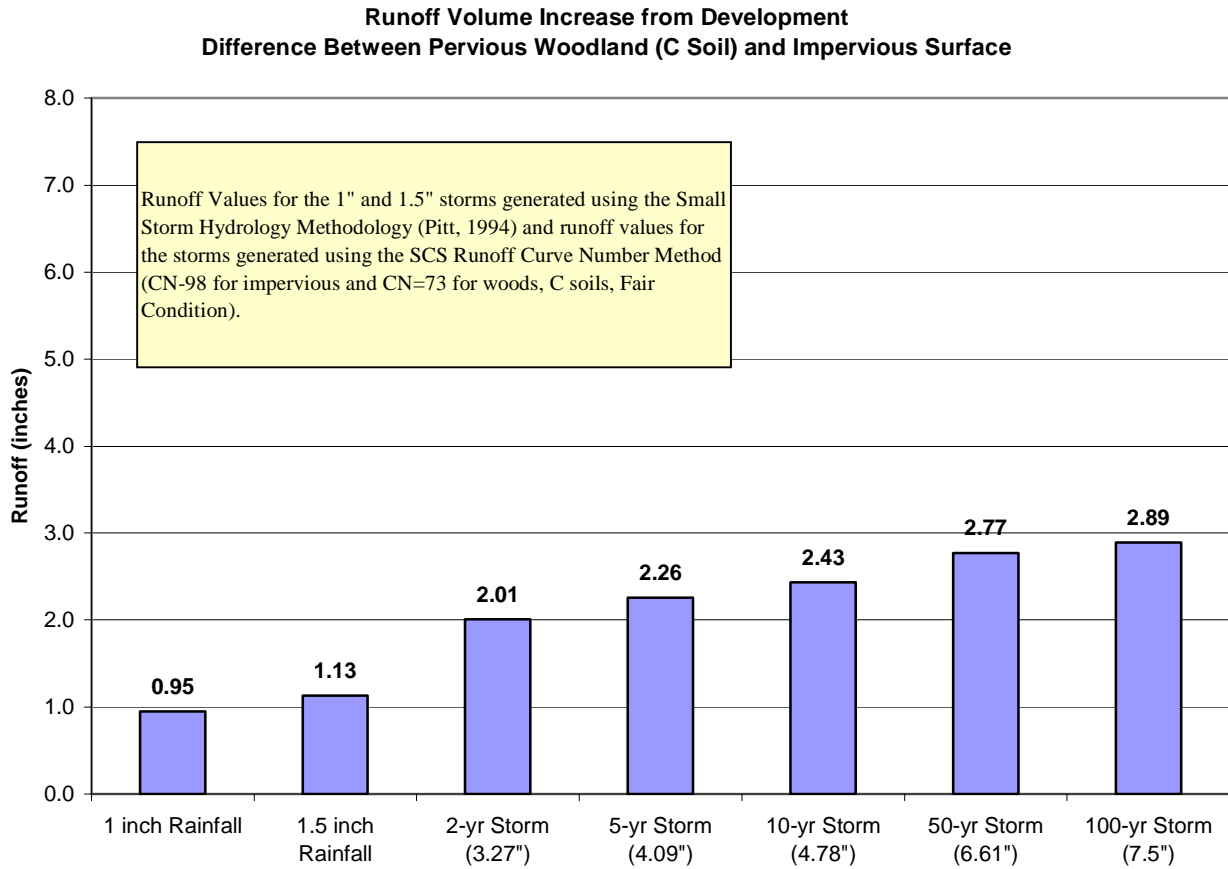
Regardless of where land development occurs, the impervious surfaces, the changes in vegetation, and the soil compaction associated with that development result in significant increases in runoff volume. When the balance of a developed site is cleared of existing vegetation, graded, and re-compacted, it produces an increase in runoff volume. While traditionally, if the original vegetation were replaced with natural vegetation, the runoff characteristics would be considered to be equivalent to the original natural vegetation. The disturbance and the compaction destroy the permeability of the natural soil.

The relative increase in runoff volume varies with event magnitude (return period). For example, the two-year rainfall of 3.27 inches/24 hours (SE PA) will result in an increase in runoff volume of 2.6 inches from every square foot of impervious surface placed on well-drained HSG B soil in woodland cover (Figure 3-1). For larger events, as the total rainfall increases, the net runoff also increases, but less than proportionately. For example, total rainfall for the 100-year storm is twice the rainfall for the 2-year storm (7.5 inches vs. 3.27 inches); however, the increase in runoff for the 100-year storm is only 1.7 inches more than the runoff for the 2-year storm (4.3 – 2.6 inches). This pattern holds true throughout the state.



**Figure 3-1. Runoff Volume Increase from Impervious Surfaces - B Soils.**

For a specific site, the net increase in runoff volume during a given storm depends on both the pre-development permeability of the natural soil and the vegetative cover. Poorly drained soils result in a smaller increase of runoff volume because the volume of pre-development runoff is already high. Therefore, the amount of runoff resulting from development does not represent a large net increase. Using the same rainfall values, Figure 3-2 illustrates that the two-year rainfall of 3.27 inches/24 hours produces an increase of only 2.01 inches on a HSG C soil, while the better drained (B) soil in Figure 3-1 produces a 2.60-inch runoff volume increase. Thus a volume control guideline must be based on the net change in runoff volume for a given frequency rainfall to be equitable throughout the state on any given development site.



**Figure 3-2. Runoff Volume Increase from Impervious Surfaces - C Soils**

Consideration of a volume control guideline has focused on providing stream channel protection and water quality protection from the frequent rainfalls that comprise a major portion of runoff events in any part of the state. On the basis of these factors, the 2-year event has been chosen as the stormwater management design storm for Volume Control Guideline 1.

Regardless of the volume reduction goal desired, it is considered unreasonable to design any stormwater BMP for greater than a 2-year event. The increase in runoff volume from the 100-year rainfall after site development is so large that it is impractical to require management of the total increase in volume. During such extreme events, the runoff simply overwhelms the natural and human-made conveyance elements of pipes and stream channels. In practice, a BMP sized for the increase in the 100-year runoff volume would be empty most of the time and would have a 1% probability of functioning at capacity in any one year. Of course, large storms need to be managed in terms of flooding and peak rate control, to the extent practicable.

**3.3.1 Volume Control Criteria**

A volume control guideline is essential to mitigate the consequences of increased runoff. To do this, the volume reduction BMP must:



1. Protect stream channel morphology;
2. Maintain groundwater recharge;
3. Prevent downstream increases in flooding; and
4. Replicate the natural hydrology on site before development to the greatest extent possible.

**Protect Stream Channel Morphology:** Increased volume of runoff results in an increase in the frequency of bank full or near bank full flow conditions in stream channels. The increased presence of high flow conditions in riparian sections has a detrimental effect on stream shaping, including stream channel and overall stream morphology. Stream bank erosion is greatly accelerated. As banks are eroded and undercut and as stream channels are gouged and straightened; meanders, pools, riffles, and other essential elements of habitat are lost or diminished. Research has demonstrated that bank-full stream flow typically occurs between the 1-year and the 2-year storm event (often around the 1.5-year storm). Urbanization can cause the natural bankfull stream flows to occur far more often. Strategies employed by the CG's include a combination of volume reduction and extended detention to reduce the bankfull flow occurrences.

**Maintain Groundwater Recharge:** Over 80 percent of the annual precipitation infiltrates into the soil mantle in Pennsylvania's watersheds under natural conditions. More than half of this is taken up by vegetation and transpired. Part of this infiltrated water moves down gradient to emerge as springs and seeps, feeding local wetlands and surface streams. The rest enters deep groundwater aquifers that supply drinking water wells. Without groundwater recharge, surface stream flows and supplies of groundwater for wells will diminish or disappear during drought periods. Certain land areas recharge more groundwater than others; therefore, protecting the critical recharge areas is important in maintaining the water cycle's balance. In round numbers, an estimate of the annual water balance is: surface water runoff, 20%; evapotranspiration (ET), 45%; groundwater recharge, 35%.

**Prevent Downstream Increases in Runoff Volume and Flooding:** Although site-based rate control measures may help protect the area immediately downstream from a development site, the increased volume of runoff and the prolonged duration of runoff from multiple development sites can increase peak flow rates and duration of flooding from runoff caused by relatively small rain events. Replicating pre-development runoff volumes for small storms will usually substantially reduce the problem of frequent flooding that plague many communities. Although control of runoff volumes from small storms almost always helps to reduce flooding during large storms, additional measures are necessary to provide adequate relief from the serious flooding that occurs during such events.

**Replicate the Surface Water Hydrology On-site Before Development:** The objective for stormwater management is to develop a program that replicates the natural hydrologic conditions of watersheds to the maximum extent practicable. However, the very process of clearing the existing vegetation from the site removes the single largest component of the natural hydrologic regime, evapotranspiration (ET). Unless the ET component is replaced, the runoff increase will be substantial. Several of the BMPs described in this manual, such as infiltration, tree planting, vegetated roof systems and rain gardens, can help replace a portion of the ET function.

### 3.3.2 Volume Control Alternatives

While the volume control guideline alternatives are quite specific concerning the volume of runoff to be controlled from a development site, they do not specify the methods by which this can be accomplished. The selection of a BMP, or combination of BMPs, is left to the design process. But in all instances, minimizing the volume increase from existing and future development is the goal. The BMPs

described in this manual place emphasis on infiltration of precipitation as an important solution; however, three methods are provided to reduce the volume of runoff from land development:

1. Infiltration;
2. Capture and Reuse; and
3. Vegetation systems that provide ET, returning rainfall to the atmosphere.

It is anticipated that many of the stormwater management systems used in Pennsylvania will include one or more of these methods, depending on specific site conditions that constrain stormwater management opportunities. Inherent in these guidelines is the assumption that all soils allow some infiltration. Where this is not possible, a vegetated roof, or bioretention combined with capture-and-reuse systems, or other forms of runoff volume control will be necessary to achieve the required capture and removal volumes.

For Regulated Activities equal or less than one acre that do not require design of stormwater storage facilities, the applicant may select either Control Guideline 1 or Control Guideline 2 on the basis of economic considerations, applicability and limitations of the analytic procedures and other factors. Control Guideline 1 may require more complex and detailed analyses while providing a greater opportunity to select stormwater controls that require fewer resources to construct and operate. For all Regulated Activities larger than one acre and for all projects that require design of stormwater storage facilities, Control Guideline 2 may not be used.

### 3.3.3 Volume Control Guideline 1

**The Control Guideline 1 is applicable to any size of the Regulated Activity. Use of Control Guideline 1 (CG-1) is recommended where site conditions offer the opportunity to reduce the increase in runoff volume as follows:**

**Do not increase the post-development total runoff volume for all storms equal to or less than the 2-year/24-hour event.**

**Existing (pre-development) non-forested pervious areas must be considered meadow (good condition) or its equivalent.**

**Twenty (20) percent of existing impervious area, when present, shall be considered meadow (good condition) in the model for existing conditions for redevelopment.**

The scientific basis for Volume Control Guideline 1 is as follows:

- The 2-year event provides stream channel protection and water quality protection for the relatively frequent runoff events across the state;
- Volume reduction BMPs based on this standard will provide a storage capacity to help reduce the increase in peak flow rates for larger runoff events;
- In a natural stream system in Mid-Atlantic States, the bank full stream flow occurs with a period of approximately 1.5 years. If the runoff volume from storms less than the 2-year event are not increased, the fluvial impacts on streams will be reduced;
- The 2-year storm is well defined and data are readily accessible for use in stormwater management calculations.

### 3.3.4 Volume Control Guideline 2

**Control Guideline 2 (CG-2) is independent of site constraints and should be used if CG-1 is not followed. This method is not applicable to Regulated Activities greater than one (1) acre or for projects that require design of stormwater storage facilities. For new impervious surfaces:**

**Stormwater facilities shall be sized to capture at least the first two inches (2") of runoff from all contributing impervious surfaces.**

**At least the first one inch (1.0") of runoff from new impervious surfaces shall be permanently removed from the runoff flow — i.e. it shall not be released into the surface Waters of this Commonwealth. Removal options include reuse, evaporation, transpiration, and infiltration.**

**Wherever possible, infiltration facilities should be designed to accommodate infiltration of the entire permanently removed runoff; however, in all cases at least the first one-half inch (0.5") of the permanently removed runoff should be infiltrated.**

The scientific basis for Volume Control Guideline 2 is as follows:

- Groundwater recharge will be maintained;
- The permanently removed volume will reduce the runoff;
- The combined permanently removed volume and extended detention volume will provide water quality protection by:
  - Capture / treatment of 95+/-% of the yearly water budget, and a higher volume of pollutants (first flush);
  - Capture / treatment of 99+/-% of the yearly storm events from paved areas. Example: for over 50 years of data on the Brandywine, 2.6 storms per year on average exceed 2";
- Volume reduction BMPs based on this standard will provide a storage capacity to reduce the increase in peak flow rates;
- In many of Pennsylvania’s natural streams, the bank full stream flow occurs with a period of approximately 1.5 years. The combination of volume reduction and extended detention will reduce the depth and frequency of flows for all events less than the 2-year event, therefore, the fluvial impacts on streams will be reduced.

### 3.3.5 Retention and Detention Considerations

**Infiltration areas should be spread out and located in the sections of the site that are most suitable for infiltration.**

**In all cases, retention and detention facilities should be designed to completely drain water quality volumes including both the permanently removed volume and the extended detention volume over a period of time not less than 24 hours and not more than 72 hours from the end of the design storm.**

### 3.4 Recommended Peak Rate Control Guideline

Peak rate control for large storms, up to the 100-year event, is essential to protect against immediate downstream erosion and flooding. Most designs achieve peak rate control through the use of detention structures. Peak rate control can also be integrated into volume control BMPs in ways that eliminate the need for additional peak rate control detention systems. Non-Structural BMPs also can contribute to rate control, as discussed in Chapters 5 and 8.

**The recommended control guideline for peak rate control is:**

**Do not increase the peak rate of discharge for the 1-year through 100-year events (at minimum); as necessary, provide additional peak rate control as required by applicable and approved Act 167 plans.**

Where Act 167 plans apply, hydrologic modeling may have been performed to provide the basis for establishing more stringent release rate controls on sub-districts within the watershed. As volume reduction BMPs are incorporated into stormwater management on a watershed basis, release rate values will require re-evaluation. Use of the control guidelines will reduce or perhaps even eliminate the increase in peak rate and runoff volume for some storms.

### 3.5 Recommended Water Quality Control Guideline

The volume control achieved through applying CG-1 and CG-2 may also remove a major fraction of particulate associated pollutants from impervious surfaces during most storms. Pervious surfaces such as “lawns” subject to continuing fertilization may generate NPS pollutants throughout a major storm, as may stream banks subjected to severe flows. While infiltration BMPs and landscape BMPs are very effective in NPS reduction, if the volume control measures simply overflow during severe storms then they will not achieve the control anticipated. Solutes will continue to be transported in runoff throughout the storm, regardless of magnitude.

CG-1 will provide water quality control and stream channel protection as well as flood control protection for most storms if the BMPs drain reasonably well and are adequately sized and distributed. CG-2 will not fully mitigate the peak rate for larger storms, and will require the addition of secondary BMPs for peak rate control. These secondary BMPs could also provide water quality control. In the event that this secondary BMP is added to assure rate mitigation during severe storms, the incorporation of vegetation could provide effective water quality controls.

The recommended control guideline for *total water quality control* is:

Achieve an 85 percent reduction in post-development particulate associated pollutant load (as represented by Total Suspended Solids), an 85 percent reduction in post-development total phosphorus loads, and a 50 percent reduction in post-development solute loads (as represented by NO<sub>3</sub>-N), all based on post-development land use.

The recommended water quality control guideline is a set of performance-based goals. The guideline does not represent specific effluent limitations but presents composite efficiency expectations that can be used to select appropriate BMPs.

These reductions may be estimated based on the pollutant load for each land use type and the pollutant removal effectiveness of the proposed BMPs, as shown in Chapters 5 and 6 and discussed in Chapter 8. The inclusion of total phosphorus as a parameter is in recognition of the fact that much of

the phosphorus in transit with stormwater is attached to the small (colloidal) particles, which are not subject to gravity settlement in conventional detention structures, except over extended periods. With infiltration or vegetative treatment, however, the removal of both suspended solids and total phosphorus should be very high.

New impervious surfaces, such as rooftops, that produce relatively little additional pollutants can be left out of the water quality impact site evaluation under most circumstances. Rainfall has some latent concentration of nitrate (1 to 2 mg/l) as the result of air pollution, but it would be unreasonable to require the removal of this pollutant load from stormwater runoff. The control of nitrate from new development should focus on reduction of fertilizer applications rather than removal from runoff.

When the proposed development plan for a site is measured by type of surface (roof, parking lot, driveway, lawn, etc.), an estimate of potential pollutant load can be made based on the volume of runoff from those surfaces, with a flow-weighted pollutant concentration applied. The total potential non-point source load can then be estimated for the parcel, and the various BMPs, both Structural and Non-Structural, can be considered for their effectiveness. This method is described in detail in Chapter 8. In general, the Non-Structural BMPs are most beneficial for the reduction of solutes, with Structural BMPs most useful for particulate reduction. Because soluble pollutants are extremely difficult to remove, prevention or reduction on the land surface, as achieved through Non-Structural BMPs described in Chapter 5, are the most effective methods for reducing them.

### **3.6 Stormwater Standards for Special Management Areas**

CG-1 and CG-2 may require modification, on a case-by-case basis, before they are applied to Special Management Areas around the Commonwealth. Special Areas include highways and roads, existing urban or developed sites, contaminated or brownfield sites, sites situated in karst topography, sites located in public water supply protection areas, sites situated in High Quality or Exceptional Value watersheds, sites situated on old mining lands, etc. These are areas where BMP application of any type may be limited. Stormwater management for these Special Management Areas is discussed in more detail in Chapter 7.



---

# **Pennsylvania Stormwater Best Management Practices Manual**

---

## **Chapter 4**

### **Integrating Site Design and Stormwater Management**







## **Chapter 4 Integrating Site Design and Stormwater Management**

<b>4.1</b>	<b>A Recommended Site Design Procedure for Comprehensive Stormwater Management.....</b>	<b>1</b>
<b>4.2</b>	<b>The Site Design Checklist for Comprehensive Stormwater Management.....</b>	<b>3</b>
<b>4.3</b>	<b>Importance of Site Assessment.....</b>	<b>7</b>
<b>4.3.1</b>	<b>Background Site Factors.....</b>	<b>7</b>
<b>4.3.2</b>	<b>Site Factors Inventory.....</b>	<b>8</b>
<b>4.3.3</b>	<b>Site Factors Analysis.....</b>	<b>8</b>



## 4.1 A Recommended Site Design Procedure for Comprehensive Stormwater Management

Chapters 5 and 6 describe multiple Non-Structural and Structural BMPs that can be used to achieve the Recommended Site Control Guidelines for comprehensive stormwater management described in Chapter 3. Obviously, not all of these BMPs are appropriate for all land development activities or every site. How can BMPs be selected to maximize their performance? What is the optimal blend between Non-Structural and Structural BMPs? How can stormwater management be best integrated into the site planning process?

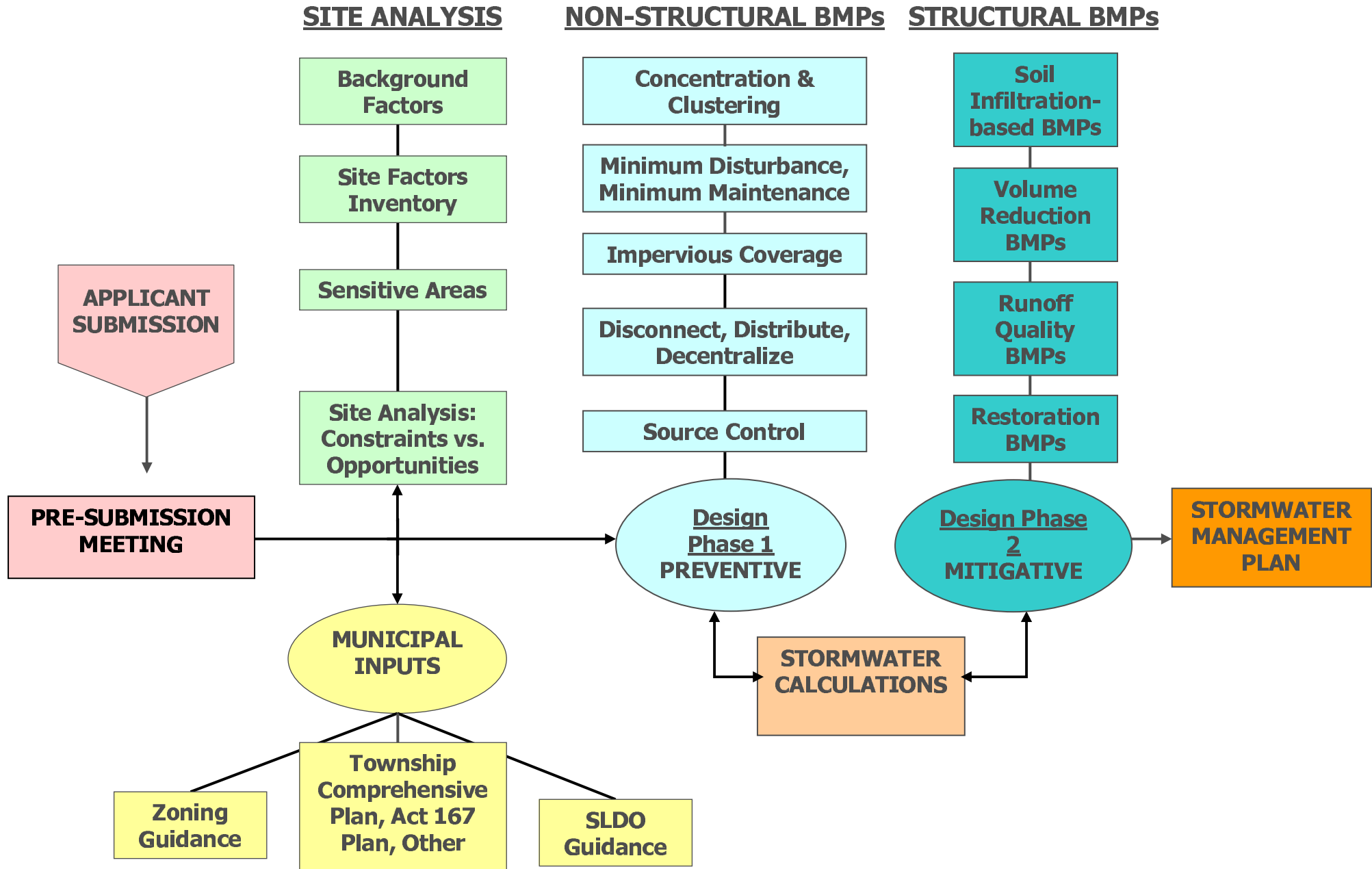
A flow chart depicting a Site Design Procedure For Comprehensive Stormwater Management (Procedure) is set forth in Figure 4-1 (also referenced to the Checklist Summary in Figure 4-2 which is discussed in Section 4.2 below). This procedure begins with an assessment of the site and its natural systems and then proceeds to integrate both Non-Structural and Structural BMPs in the formulation of a comprehensive stormwater management plan. The intent of the planning process is to promote development of stormwater management “solutions” which achieve the rigorous quantity and quality standards set forth in Chapter 3. Some aspects of the procedure will not be fully applicable in all land development cases. For example, Non-Structural BMPs may be challenging to apply in those cases where higher densities/intensities are proposed on the smallest of sites in already developed areas.

An essential objective of the Procedure is to maximize stormwater “prevention” through use of Non-Structural BMPs (Chapter 5). Once prevention has been maximized, some amount of stormwater peaking and volume control will likely remain to be managed. These stormwater management needs should be met with an array of natural-system based Best Management Practices (Vegetated Swales, Vegetated Filter Strips, etc.), with the remaining stormwater management needs met with structural Best Management Practices such as infiltration basins, trenches, porous pavement, wet basins, retention ponds, constructed wetlands, and others presented in Chapter 6.

This Procedure, or a process similar to it, is an integral part of comprehensive stormwater management and transcends the bounds of conventional stormwater management that has existed in most Pennsylvania municipalities. Perhaps most importantly, the Procedure involves the total site design process. Conventional stormwater management has usually been relegated to the final stages of the site design and overall land development process, after most other building program issues have been determined and accommodated. To the contrary, the Procedure places stormwater management in the initial stages of site planning process, when the building program is being fitted and tested on the site. In this way, comprehensive stormwater management can be integrated effectively into the site design process.

Figure 4-1 Recommended procedures for comprehensive stormwater management.

# SITE PLANNING AND DESIGN PROCEDURE



Much of the information relied on for the Procedure is information already required to satisfy other aspects of existing municipal land development ordinances. The Procedure is intended to more effectively utilize this already-collected site data to generate better stormwater management in the context of a markedly improved site plan. To the extent that this information is not already being collected and assessed, the information needs to be collected as part of the site design process.

## **4.2 The Site Design Checklist for Comprehensive Stormwater Management**

Coordinated with the Recommended Site Design Procedure for Comprehensive Stormwater Management is a series of questions structured to facilitate and guide an assessment of the site's natural features and stormwater management needs. The Site Design Checklist for Comprehensive Stormwater Management (Figure 4-2) is intended to help facilitate the Procedure. The initial questions in the Checklist focus on Site Analysis, including Background Site Features, a Site Factors Inventory, Site Factors Analysis and Constraints and Opportunities. The checklist relates directly to the first Non-Structural BMP category: Protect Sensitive and Special Value Features, which include:

- BMP 5.4.1 Protect Sensitive/Special Value features**
- BMP 5.4.2 Protect/consERVE/enhance utilize riparian areas**
- BMP 5.4.3 Protect/utilize natural flow pathways in overall stormwater planning and design**

Because these first steps in the Procedure are so important, they are further discussed below in Section 4.3 – “Importance of Site Assessment”.

The Procedure continues with potentially multiple cycles of “testing” and “fitting” preventive Non-Structural BMPs at the site. The Checklist provides questions designed to identify the potential application of additional Non-Structural BMPs. Once Non-Structural BMPs have been “maximized,” the Recommended Procedure then continues with the testing/fitting of Structural BMPs, again facilitated by the Checklist questions. This testing/fitting of Non-Structural and Structural BMPs can continue through several cycles. At the completion of the Procedure, a comprehensive stormwater management plan emerges, satisfying the Chapter 3 Recommended Site Control Guidelines. If the Checklist questions are addressed thoroughly and the Procedure is fully and effectively applied, the critical objective of managing stormwater comprehensively will be achieved in a cost effective manner. The Procedure, though largely common sense, constitutes a change from conventional engineering practice in many Pennsylvania municipalities.

(Figure 4-2) Checklist summary for use with Site Planning and Design Procedure

<b>SITE ANALYSIS</b>	
<p><b>Background Site Factors</b></p> <p><i>Describe hydrologic context and other natural elements</i></p> <ul style="list-style-type: none"> <li>Chapter 93 stream use designation?                             <ul style="list-style-type: none"> <li>Special Protection Waters (EV, HQ)?</li> <li>Fishery / Aquatic Life Use (WWF, CWF, TSF)?</li> </ul> </li> <li>Any Chapter 303d/impaired stream listing classifications?</li> <li>Aquatic biota sampling?</li> <li>Existing water quality sensitivities downstream (water supply source?)?</li> <li>Location of any known downstream flooding?</li> <li>Includes any Special Areas?                             <ul style="list-style-type: none"> <li>Such as Previously Mined AMD/AML areas?</li> <li>Brownfields?</li> <li>Source Water Protection areas</li> <li>Urban Areas?</li> <li>Carbonate/Limestone?</li> <li>Slide Prone Areas</li> <li>Other</li> </ul> </li> </ul> <p><b>Site Factors Inventory</b></p> <p><i>Describe the size and shape of the site</i></p> <ul style="list-style-type: none"> <li>Special constraints/opportunities?</li> <li>Special site border conditions and adjacent uses?</li> </ul> <p><i>Describe the existing developed features of the site, if any</i></p> <ul style="list-style-type: none"> <li>Existing structures/improvements, structures to be preserved?</li> <li>Existing cover/uses?</li> <li>Existing impervious areas?</li> <li>Existing pervious maintained areas?</li> <li>Existing public sewer and water?</li> <li>Existing storm drainage systems at/adjacent to site?</li> <li>Existing wastewater, water systems onsite?</li> </ul> <p><i>Describe important natural features of site</i></p> <ul style="list-style-type: none"> <li>Existing hydrology (drainage swales, intermittent, perennial)?</li> <li>Existing topography, contours, subbasins?</li> <li>Soil series found on site and their Hydrologic Soil Group ratings?</li> <li>Areas of vegetation (trees, scrub, shrub)?</li> <li>Special Value Areas?                             <ul style="list-style-type: none"> <li>Wetlands, hydric soils?</li> <li>Floodplains/alluvial soils?</li> <li>High quality woodlands, other woodlands and vegetation?</li> <li>Riparian buffers?</li> <li>Naturally vegetated swales/drainageways?</li> </ul> </li> <li>Sensitive Areas?                             <ul style="list-style-type: none"> <li>Steep slopes?</li> <li>Special geologic conditions (limestone)?</li> <li>Shallow bedrock (less than 2ft)?</li> <li>High water table (less than 2ft)?</li> </ul> </li> <li>PNDI areas or species?</li> </ul> <p><b>Site Factors Analysis</b></p> <p><i>Characterize the constraint-zones at site</i></p> <ul style="list-style-type: none"> <li>Avoid development on or near special and sensitive natural features</li> </ul> <p><i>Characterize the opportunity-zones at site</i></p> <ul style="list-style-type: none"> <li>Location of well-draining soils</li> <li>Location and quality of existing vegetation</li> <li>Has a Potential Development Area been defined?</li> <li>Does building program fit the constraints and opportunities of natural features?</li> </ul>	BACKGROUND SITE CONDITIONS

MUNICIPAL INPUTS		BACKGROUND SITE CONDITIONS
<p><b>Township Comprehensive Plan and Zoning guidance</b>                      Guidance in Comprehensive Plan?                      Existing Zoning District?                          Total number of units allowed?                          Type of units?                          Density of units?                      Any allowable options?</p> <p><b>Township SLDO guidance and options</b>                      Performance standards for neo-traditional, village, hamlet planning?                      Reduce building setbacks?                      Curbs required?                      Street width, parking requirements, other impervious requirements?                      Cut requirements?                      Grading requirements?                      Landscaping requirements?</p> <p><b>Township SLDO/stormwater requirements</b>                      Peak rate and design storms?                      Total runoff volume?                      Water quality provisions?                      Methodological requirements?                      Maintenance requirements?</p> <p><b>Is applicant submission complete? Fully responsive to municipal zoning/SLDO requirements?</b></p> <p><b>Are municipal zoning/SLDO requirements inadequate?</b></p> <p><b>Is useful interaction at sketch plan or even pre-sketch plan phases occurring?</b></p>		
SITE DESIGN: NON-STRUCTURAL BMPs		DESIGN PHASE 1: PREVENTIVE
<p><b>Lot Concentration and Clustering</b>  <i>Reduce individual lot size?</i>  <i>Concentrate/cluster uses and lots?</i>  <i>Configure lots to avoid critical natural areas ?</i>  <i>Configure lots to take advantage of effective mitigative stormwater practices?</i>  <i>Orient built structures to fit natural topography?</i>  <i>Minimize site disturbance (excavation / grading) at site?</i>  <i>Minimize site disturbance (excavation / grading) for each lot?</i></p> <p><b>Minimum Disturbance/Maintenance</b>  <i>Define disturbance zones for site?</i>                          Protect maximum total site area from development disturbance?                          Protect naturally sensitive and special areas from disturbance?  <i>Minimize total site compaction?</i>  <i>Maximize zones of open space and greenways?</i>  <i>Consider re-forestation and re-vegetation opportunities?</i></p> <p><b>Impervious Coverage Reduction</b>  <i>Reduce road widths? Lengths?</i>  <i>Utilize turnarounds? Cul-de-sacs with vegetated islands?</i>  <i>Reduce driveway length and width?</i>  <i>Reduce parking ratios?</i>  <i>Reduce parking sizes?</i>  <i>Examine potential for shared parking?</i>  <i>Utilize porous surfaces for applicable parking features (overflow)?</i>  <i>Design sidewalks for single-side street movement?</i></p> <p><b>Disconnect/Distribute/Decentralize</b>  <i>Rooftop disconnection?</i>                          Existing downgradient yard area opportunities?                          Existing downgradient vegetated areas/woods?  <i>Disconnection from storm sewers/street gutters?</i>                          Front/side yard opportunities?                          Space for vegetated swales, rain gardens, etc.?</p> <p><b>Source Control</b>  <i>Provisions for street sweeping? Other?</i></p>		

<b>SITE DESIGN: STRUCTURAL BMPs</b>	
<p><b>Volume/Peak Rate Through Infiltration</b>  <i>Porous Pavement with Infiltration Beds?</i>  <i>Infiltration Basins?</i>  <i>Infiltration Trenches?</i>  <i>Rain Garden/Bioretenion?</i>  <i>Dry Wells/Seepage Pits?</i>  <i>Vegetated Swales?</i>  <i>Vegetated Filter Strips?</i>  <i>Infiltration Berm/Retentive Grading?</i></p> <p><b>Volume/Peak Rate Reduction</b>  <i>Vegetated Rooftops?</i>  <b>Capture &amp; Reuse:</b>              Cisterns?              Rain Barrels?              Other?</p> <p><b>Runoff Quality/Peak Rate Reduction</b>  <i>Constructed wetland?</i>  <i>Wet pond/retention basin?</i>  <i>Dry extended detention basin?</i>  <b>Water quality filters: Constructed and Other</b>              Sand and sand/peat?              Multi-chamber catch basins and inlets?              Other types?</p> <p><b>Other</b>  <i>Level Spreaders?</i>  <i>Special Detention Storage: Parking Lots, Other</i></p> <p><b>Site Restoration for Stormwater</b>  <i>Riparian Buffer Restoration?</i>  <i>Landscape Restoration</i>  <i>Soil Amendment/Restoration</i></p> <p><b>Protocols</b>  <i>Soil Testing</i>  <i>Site Infiltration</i></p>	<b>DESIGN PHASE 1: MITIGATIVE</b>
<b>STORMWATER METHODOLOGY AND CALCULATIONS</b>	
<p><b>Iterative Process Occurring Throughout Planning and Design Practices to Max out Non-Structural and Structural Practices</b>          Use acceptable methods, such as Soil Cover Complex Method (TR-55) for calculations          Do not use Weighted Curve Numbers!</p> <p><b>Strive to:</b>          Minimize the pre to post development increase in Curve Numbers          Maximize post-development Time of Concentration          Assume "conservative" pre-development cover conditions (i.e., Curve Numbers) such as "Meadow Good" or "Woods" for all pre-development pervious areas?          Respect natural sub-areas in the design and engineering calculations</p> <p><b>Strive To Achieve Standards of Comprehensive Stormwater Management</b>          No increase in volume of runoff, pre to post development, for up to the 2-yr storm          No reduction in total volume of recharge, for up to the 2-yr storm          No increase in peak rate of runoff, small to large storms          No increase in pollutant loading</p>	<b>SOTRMWATER CALCULATIONS</b>
<b>DEVELOP COMPREHENSIVE STORMWATER MANAGEMENT PLAN</b>	
<p><b>Has There Been Thorough Approach To Use of Both Non-Structural and Structural BMP's?</b>  <i>If not, what non-structurals and structurals might be used?</i>  <i>Should the building program be modified?</i></p> <p><b>What Related Benefits Are Being Achieved Through The Use of BMPs?</b></p>	<b>PLAN</b>



### 4.3 Importance of Site Assessment

Comprehensive stormwater management begins with a thorough assessment of the site and its natural systems. Site assessment includes inventorying and evaluating the various natural resource systems which define each site and pose both problems and opportunities for stormwater management. Resources include the full range of natural systems such as water quantity, water quality, floodplains and riparian areas, wetlands, soils, geology, vegetation, and more. Natural systems range in scale from resources of areawide importance on a macro scale, down to micro- and site-specific detail.

#### 4.3.1 Background Site Factors

Broader system characteristics should be described, including State Chapter 93 stream classifications, presence of Special Protection Waters, stream order (i.e., 1<sup>st</sup> order, 2<sup>nd</sup> order, etc.), source water supply designations, 303d/TMDL/Impaired Stream designations, flooding history, and other information that provides an understanding of how a particular site is functioning within its watershed context. More specific questions would include:

- Does the site drain to special waterbodies with special water quality needs?
- Determine if the site ultimately flows into a reservoir or other water body where special water quality sensitivities exist, such as use as a water supply source.
- Determine if a special fishery exists.
- Determine if the site is linked to a special habitat system, such as delineated in the Pennsylvania Natural Diversity Inventory. For both water quality and temperature reasons, approaches and practices that achieve a higher order of protection may become especially important.

#### **Are there known downstream flooding problems?**

Determine if a stream system to which the site discharge is currently experiencing flooding problems. This is especially important where urbanization already has occurred and where hydrology already has been altered. Unfortunately, the existing FEMA mapping and related studies do not adequately assess this issue. County agencies and municipal offices may be able to indicate anecdotally the extent to which downstream flooding is already a problem or has the potential to become a problem if substantial additional development is projected. Greater care should be taken in both floodplain management as well as stormwater management if problems exist or are anticipated.

#### **Does the site discharge to 1st, 2nd, 3rd order streams?**

Another important question relates to the site's location within its watershed. Sites located near the base of watersheds pose less of a threat to the hydrologic characteristics of the watershed system. Sites located farther up the watershed are potentially more problematic when additional stormwater is generated. Perhaps even more critical, sites located within headwaters must be managed most carefully in terms of stormwater to maintain pre-development infiltration and groundwater recharge rates.

### 4.3.2 Site Factors Inventory

Site-specific factors that influence comprehensive stormwater management include the following items:

#### **How does site size and shape affect stormwater management?**

As site size increases, the ability to use a variety of Non-Structural and Structural BMPs increases. Comprehensive stormwater management, especially through site planning and the use of Non-Structural BMPs, can reduce space requirements at a site and offer greater BMP flexibility. Oddly shaped sites can also be better adapted with BMPs set forth here, given their wide variety of shapes and sizes.

#### **What are the important natural features characterizing the site?**

At the heart of the comprehensive stormwater management procedure is an understanding of the natural systems characterizing each site. Existing vegetation and soil have tremendous importance and are the key to understanding land development impacts on natural systems. Careful accounting of existing vegetation is an important prerequisite for comprehensive stormwater management, followed closely by soils mapping for permeability ratings, and natural pre-development surface flow patterns. Critical site features, such as wetlands, floodplains, riparian areas, natural drainage ways, special habitat areas, special geological formations (e.g., carbonate), steep slopes, shallow depth to water table, shallow depth to bedrock, and other factors should be inventoried and understood. Critical areas include those with special positive functions that can be translated into real economic value or benefit. Elimination or reduction of these functions through the land development process leads to real economic losses. These special value areas, including wetlands and floodplains and riparian areas, should be conserved and protected during land development. Critical natural areas also include sensitive areas, such as steep slopes, shallow bedrock, high water table areas, and other constraining features, where encroachment by land development typically creates unnecessary or unanticipated problems. Care must be taken to avoid these potential pitfalls.

### 4.3.3 Site Factors Analysis

Identify site factors that constrain comprehensive stormwater management, and identify site factors that can be viewed as opportunities.

#### **How is the site constrained?**

Determine where buildings, roads, and other disturbance should be avoided and why.

#### **Where are the zones of site “opportunity,” in terms of stormwater management?**

Determine where most infiltration occurs in terms of vegetation and in terms of soils. Both constraints and opportunities are grounded in the natural systems present at the site. Constraints and opportunities are not necessarily simple opposites of one another. For example, certain types of critical natural areas should be viewed as constraints in terms of direct land disturbance and building construction, yet also provide significant opportunity in terms of stormwater management, quantity and quality. Woodlands, which should be protected from direct land development, provide excellent opportunity for stormwater management, provided that the correct approaches and practices are

used. Vegetated riparian buffers should not be disturbed for building and road construction yet they can be used carefully with level spreading devices to receive diffuse stormwater runoff. Soils with maximum permeabilities at the site should not be made impervious with buildings and roads, but used for stormwater management where feasible. Conversely, buildings and other impervious areas should be located on those portions of a site with least permeable soils. Site opportunities for volume control can typically be defined in terms of vegetation types that minimize runoff, as well as soil types with maximum permeabilities.



---

# **Pennsylvania Stormwater Best Management Practices Manual**

---

## **Chapter 5**

### **Non-Structural BMPs**





## Chapter 5 Non-Structural BMPs

<b>5.1</b>	<b>Introduction.....</b>	<b>1</b>
<b>5.2</b>	<b>Non-Structural Best Management Practices.....</b>	<b>1</b>
<b>5.3</b>	<b>Non-Structural BMPs and Stormwater Methodological Issues.....</b>	<b>3</b>
<b>5.4</b>	<b>Protect Sensitive and Special Value Resources</b>	
	<b>BMP 5.4.1 Protect Sensitive/Special Value Features.....</b>	<b>7</b>
	<b>BMP 5.4.2 Protect/Conserve/Enhance Riparian Areas.....</b>	<b>13</b>
	<b>BMP 5.4.3 Protect/Utilize Natural Flow Pathways in Overall Stormwater Planning and Design.....</b>	<b>21</b>
<b>5.5</b>	<b>Cluster and Concentrate</b>	
	<b>BMP 5.5.1 Cluster Uses at Each Site; Build on the Smallest Area Possible.....</b>	<b>29</b>
	<b>BMP 5.5.2 Concentrate Uses Area wide through Smart Growth Practices.....</b>	<b>37</b>
<b>5.6</b>	<b>Minimize Disturbance and Minimize Maintenance</b>	
	<b>BMP 5.6.1 Minimize Total Disturbed Area – Grading.....</b>	<b>49</b>
	<b>BMP 5.6.2 Minimize Soil Compaction in Disturbed Areas.....</b>	<b>57</b>
	<b>BMP 5.6.3 Re-Vegetate and Re-Forest Disturbed Areas, Using Native Species.....</b>	<b>63</b>
<b>5.7</b>	<b>Reduce Impervious Cover</b>	
	<b>BMP 5.7.1 Reduce Street Imperviousness.....</b>	<b>71</b>
	<b>BMP 5.7.2 Reduce Parking Imperviousness.....</b>	<b>77</b>
<b>5.8</b>	<b>Disconnect/Distribute/Decentralize</b>	
	<b>BMP 5.8.1 Rooftop Disconnection.....</b>	<b>85</b>
	<b>BMP 5.8.2 Disconnection from Storm Sewers.....</b>	<b>89</b>
<b>5.9</b>	<b>Source Control</b>	
	<b>BMP 5.9.1 Streetsweeping.....</b>	<b>95</b>





## Chapter 5 Comprehensive Stormwater Management: Non-Structural BMPs

### 5.1 Introduction

The terms “Low Impact Development” and “Conservation Design” refer to an environmentally sensitive approach to site development and stormwater management that minimizes the effect of development on water, land and air. This chapter emphasizes the integration of site design and planning techniques that preserve natural systems and hydrologic functions on a site through the use of Non-Structural BMPs. Non-Structural BMP deployment is not a singular, prescriptive design standard but a combination of practices that can result in a variety of environmental and financial benefits. Reliance on Non-Structural BMPs encourages the treatment, infiltration, evaporation, and transpiration of precipitation close to where it falls while helping to maintain a more natural and functional landscape. The BMPs described in this chapter preserve open space and working lands, protect natural systems, and incorporate existing site features such as wetlands and stream corridors to manage stormwater at its source. Some BMPs also focus on clustering and concentrating development, minimizing disturbed areas, and reducing the size of impervious areas. Appropriate use of Non-Structural BMPs will reflect the ten “Principles” presented in the Foreword to this manual, and will be an outcome of applying the procedures described in Chapter 4.

From a developer’s perspective, these practices can reduce land clearing and grading costs, reduce infrastructure costs, reduce stormwater management costs, and increase community marketability and property values. Blending these BMPs into development plans can contribute to desirability of a community, environmental health and quality of life for its residents. Longer term, they sustain their stormwater management capacity with reduced operation and maintenance demands.

Conventional land development frequently results in extensive site clearing, where existing vegetation is destroyed, and the existing soil is disturbed, manipulated, and compacted. All of this activity significantly affects stormwater quantity and quality. These conventional land development practices often fail to recognize that the natural vegetative cover, the soil mantle, and the topographic form of the land are integral parts of the water resources system that need to be conserved and kept in balance, even as land development continues to occur.

As described in Chapter 4, identifying a site’s natural resources and evaluating their values and functional importance is the first step in addressing the impact of stormwater generated from land development. Where they already exist on a proposed development site, these natural resources should be conserved and utilized as a part of the stormwater management solution. The term “green infrastructure” is often used to characterize the role of these natural system elements in preventing stormwater generation, infiltrating stormwater once it’s created, and then conveying and removing pollutants from stormwater flows. Many vegetation and soil-based structural BMPs are in fact “natural structures” that perform the functions of more “structural” systems (e.g., porous pavement with recharge beds). Because some of these “natural structures” can be designed and engineered, they are discussed in Chapter 6 as structural BMPs.

### 5.2 Non-Structural Best Management Practices

This Manual differentiates BMPs based on Non-Structural (Chapter 5) and Structural (Chapter 6) designations. Non-Structural BMPs take the form of broader planning and design approaches – even principles and policies – which are less “structural” in their form, although non-structural BMPs do have

very important physical ramifications. An excellent example would be “reducing imperviousness” (see BMPs 5.9 and 5.10 below) by reducing road width and/or reducing parking ratios. In this way, a proposed building program can be accommodated but with reduced stormwater generation. These non-structural BMPs can be applied over an entire site and are not fixed and designed at one location. Virtually all of the Non-Structural BMPs set forth in this Chapter of the manual share this kind of site-wide policy characteristic. Structural BMPs, on the other hand, are decidedly more locationally specific and explicit in their physical form.

Sometimes called Low Impact Development or Conservation Design techniques, Non-Structural BMPs are not always markedly different from Structural BMPs. In fact, some of the BMPs described in Chapter 6, such as Vegetated Swales and Vegetated Filter Strips, are largely based in natural systems and are intended to function as they would have prior to disturbance. Nevertheless, such BMPs can be thought of as natural structures, which are designed to mitigate any number of stormwater impacts: peak rates, total runoff volumes, infiltration and recharge volumes, non-point source water quality loadings and temperature increases.

Perhaps the most defining distinction for the Non-Structural BMPs set forth in this chapter is their ability to prevent stormwater generation and not just mitigate stormwater-related impacts once these problems have been generated. Prevention can be achieved by developing land in ways other than through use of standard or conventional development practices. Prevention and Non-Structural BMPs go hand in hand and can be contrasted with Structural BMPs that provide mitigation of those stormwater impacts, which cannot be prevented and/or avoided.

Several major “areas” of preventive Non-Structural BMPs have been identified in this manual:

**Protect Sensitive and Special Value Features**  
**Cluster and Concentrate**  
**Minimize Disturbance and Minimize Maintenance**  
**Reduce Impervious Cover**  
**Disconnect/Distribute/Decentralize**  
**Source Control**

More specific Non-Structural BMPs have been identified for each of these generalized areas to better define and improve implementation of each of these areas. This list of specific BMPs will be refined and expanded as these stormwater management practices become more common throughout Pennsylvania.

A uniform format has been developed for the BMPs presented in Chapters 5 and 6 of this manual. It provides as many engineering details as possible, facilitated through diagrams, graphics and pictures. There are constant tradeoffs that must be made between providing a more complete explanation for the countless variations which can be expected to emerge across the state versus the need to be concise and user friendly.

The uniform format has been applied to all of the Non-Structural BMPs included in Chapter 5, to encourage recognition that these Non-Structural techniques are every bit as essential as the techniques presented in Chapter 6 Structural BMPs.

One of the most challenging technical issues considered in this manual involves the selection of BMPs that have a high degree of NPS reduction or removal efficiency. In the ideal, a BMP should be selected that has a proven NPS pollutant removal efficiency for all pollutants of importance, especially those that are critical in a specific watershed (as defined by a TMDL or

other process). Both Non-Structural BMPs in Chapter 5 and Structural BMPs in Chapter 6 are rated in terms of their anticipated pollutant removal performance or effectiveness. The initial BMP selection process analyzes the final site plan and estimates the potential NPS load, using Appendix A. The targeted reduction percentage for representative pollutants (such as 85% reduction in TSS and TP load and 50% reduction in the solute load) is achieved by a suitable combination of Non-Structural and Structural BMPs. This process is described in more detail in Chapter 8.

### **5.3 Non-Structural BMPs and Stormwater Methodological Issues**

The methodological approach set forth in Chapter 8 provides a variety of straightforward and conservative ways to take credit for applying Non-Structural BMPs, provided that the “specifications” defined for each BMP in Chapter 5 are properly followed.

Because so many of the Non-Structural BMPs seem so removed from the conventional practice of stormwater engineering, putting these BMPs into play may be a challenge. Many of these Non-Structural BMPs ultimately require a more sophisticated approach to total site design. Some of the Non-Structural BMPs don't easily lend themselves to stormwater calculations as conventionally performed. How do we get stormwater credit for applying any of these techniques? Taking BMPs 5.6.1 and 5.6.2 again as examples, minimizing impervious cover by reducing road width or impervious parking area directly translates into reduced stormwater volumes and reduced stormwater rates of runoff. Site planners and designers will also recognize that many of the other Non-Structural BMPs, such as clustering of uses, conserving existing woodlands and other vegetative cover, and disconnecting impervious area runoff flows, all translate into reduced stormwater volume and rate calculations. As such, these BMPs are self-crediting.



## **5.4 Protect Sensitive and Special Value Resources**



## BMP 5.4.1: Protect Sensitive and Special Value Features



To minimize stormwater impacts, land development should avoid affecting and encroaching upon areas with important natural stormwater functional values (floodplains, wetlands, riparian areas, drainageways, others) and with stormwater impact sensitivities (steep slopes, adjoining properties, others) wherever practicable. This avoidance should occur site-by-site and on an area wide basis. Development should not occur in areas where sensitive/special value resources exist so that their valuable natural functions are not lost, thereby doubling or tripling stormwater impacts. Resources may be weighted according to their functional values specific to their municipality and watershed context.

<p style="text-align: center;"><b><u>Key Design Elements</u></b></p> <ul style="list-style-type: none"> <li>▪ Identify and map floodplains and riparian area</li> <li>▪ Identify and map wetlands</li> <li>▪ Identify and map woodlands</li> <li>▪ Identify and map natural flow pathways/drainage ways</li> <li>▪ Identify and map steep slopes</li> <li>▪ Identify and map other sensitive resources</li> <li>▪ Combine for Sensitive Resources Map (including all of the above)</li> <li>▪ Distinguish between including Highest Priority Avoidance Areas and Avoidance Areas</li> <li>▪ Identify and Map Potential Development Areas (all those areas not identified on the Sensitive Resources Map)</li> <li>▪ Make the development program and overall site plan conform to the Development Areas Map to the maximum; minimize encroachment on Sensitive Resources.</li> </ul>	<p style="text-align: center;"><b><u>Potential Applications</u></b></p> <p>Residential:  Commercial: Ultra Yes Yes  Urban: Industrial: Yes Yes  Retrofit: Yes Yes  Highway/Road:</p>
	<p style="text-align: center;"><b><u>Stormwater Functions</u></b></p> <p>Volume Reduction: Very High  Recharge: Very High  Peak Rate Control: Very High  Water Quality: Very High</p>
	<p style="text-align: center;"><b><u>Water Quality Functions</u></b></p> <p>TSS: Preventive  TP: Preventive  NO3: Preventive</p>

## Description

A major objective for stormwater-sensitive site planning and design is to avoid encroachment upon, disturbance of, and alteration to those natural features which provide valuable stormwater functions (floodplains, wetlands, natural flow pathways/drainage ways) or with stormwater impact sensitivity (steep slopes, historic and natural resources, adjoining properties, etc.) Sensitive Resources also include those resources of special value (e.g., designated habitat of threatened and endangered species that are known to exist and have been identified through the Pennsylvania Natural Diversity Inventory or PNDI). The objective of this BMP is to avoid harming Sensitive/Special Value Resources by carefully identifying and mapping these resources from the initiation of the site planning process and striving to protect them while defining areas free of these sensitivities and special values (Potential Development Areas). BMP 5.4.2 Protect/Conserve/Enhance Riparian Areas and BMP 5.6.2 Minimize Soil Compaction in Disturbed Areas build on recommendations included in this BMP.

## Variations

- BMP 5.4.1 calls for actions both on the parts of the municipality as well as the individual landowner and/or developer. Pennsylvania municipalities may adopt subdivision/land development ordinances which require that the above steps be integrated into their respective land development processes. A variety of models are available for municipalities to facilitate this adoption process, such as through the PADCNR *Growing Greener* program.

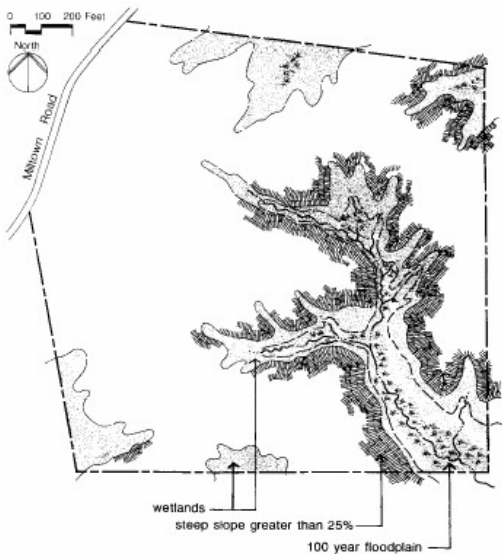


Figure 5.1-1. *Growing Greener's Conservation Subdivision Design: Step One, Part One – Identify primary conservation areas.*

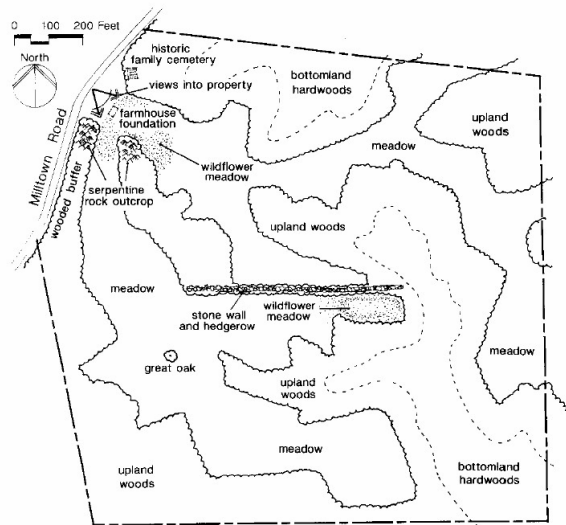


Figure 5.1-2. *Growing Greener's Conservation Subdivision Design: Step One, Part Two – Identify secondary conservation areas.*

Source: *Growing Greener: Putting Conservation Into Local Codes*; Natural Land Trusts, Inc. 1997



- The above steps use the *Growing Greener* Primary Conservation Areas and Secondary Conservation Areas designations and groupings. Identify and map the essential natural resources, including those having special functional value and sensitivity from a stormwater perspective, and then avoid developing (destroying, reducing, encroaching upon, and/or impacting) these areas during the land development process. Additionally, it is possible that Primary and Secondary can be defined in different ways so as to include different resources.

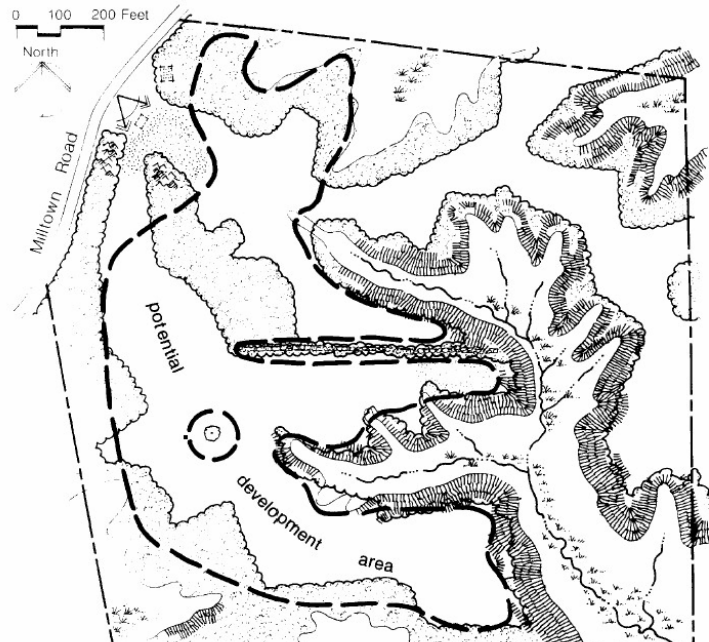


Figure 5.1-3. *Growing Greener's Conservation Subdivision Design: Step One, Part Three – potential development areas.*

Source: *Growing Greener: Putting Conservation Into Local Codes; Natural Land Trusts, Inc. 1997*

- Definition of the natural resources themselves can be varied. The definition of Riparian Buffer Area varies. Woodlands may be defined in several ways, possibly based on previous delineation/definition by the municipality or by another public agency. It is important to note here that Wooded Areas, which may not rank well in terms of conventional woodland definitions, maintain important stormwater management functions and should be included in the delineation/definition. Intermittent streams/swales/natural flow pathways are especially given to variability. Municipalities may not only integrate the above steps within their subdivision/land development ordinances, but also define these natural resource values as carefully as possible in order to minimize uncertainty.
- The level of rigor granted to Priority Avoidance and Avoidance Areas may be made to vary in a regulatory manner by the municipality and functionally by the owner and/or developer. A municipal ordinance may prohibit and/or otherwise restrict development in Priority Avoidance Areas and even Avoidance Areas. All else being equal, the larger the site, the more restrictive these requirements may be.

## Applications

A number of communities across Pennsylvania have adopted ordinances that require natural resources to be identified, mapped, and taken into account in a multi-step process similar to the Growing Greener program. These include:

BUCKS COUNTY  
Milford Township SLDO (Sep. 2002)

CHESTER COUNTY  
London Britain Township (1999)  
London Grove Township (2001)  
Newlin Township (1999)  
North Coventry Township (Dec. 2002)  
Wallace Township (1994)  
West Vincent Township (1998)

MONTGOMERY COUNTY  
Upper Salford Township (1999)

MONROE COUNTY  
Chestnuthill Township (2003)  
Stroud Township SLDO (2003)

YORK COUNTY  
Carroll Township (2003)



*Figure 5.1-4. Steep slope development with woodland removal.*

BMP 5.4.1 applies to all types of development in all types of municipalities across Pennsylvania, although variations as discussed above allow for tailoring according to different development density/intensity contexts.

## Design Considerations

Not applicable.

## Detailed Stormwater Functions

Impervious cover and altered pervious covers translate into water quantity and water quality impacts as discussed in Chapter 2 of this manual. Additional impervious area may further eliminate or in some way reduce other natural resources that were having especially beneficial functions.

Water quality concerns include all stormwater pollutant loads from impervious areas, as well as all pollutant loads from the newly created maintained landscape (i.e., lawns and other). Much of this load is soluble in form (especially fertilizer-linked nitrogen forms). Clustering as defined here, and combined with other Chapter 5 Non-Structural BMPs, minimizes impervious areas and the pollutant loads related to these impervious areas. After Chapter 5 BMPs are optimized, “unavoidable” stormwater is then directed into BMPs as set forth in Chapter 5, to be properly treated. Similarly, for all stormwater pollutant load generated from the newly-created maintained landscape, clustering as defined here, and

combined with other Chapter 5 Non-Structural BMPs, minimizes pervious areas and the pollutant loads related to these pervious areas, thereby reducing the opportunity for fertilization and other chemical application. Water quality prevention accomplished through Non-Structural BMPs in Chapter 5 is especially important because Chapter 6 Structural BMPs remain poor performers in terms of mitigating/removing soluble pollutants that are especially problematic in terms of this pervious maintained landscape. See Appendix A for additional documentation of the water quality benefits of clustering.

See Chapter 8 for additional volume reduction calculation work sheets, additional peak rate reduction calculation work sheets, and additional water quality mitigation work sheets.

### **Construction Issues**

Clearly, application of this BMP is required from the start of the site planning and development process. In fact, not only must the site developer embrace BMP 5.4.1 from the start of the process, the BMP assumes that the respective municipal officials have worked to include clustering in municipal codes and ordinances, as is the case with so many of these Chapter 5 Non-Structural BMPs.



*Figure 5.1-5. Example of steep slope development.*

### **Maintenance Issues**

As with all Chapter 5 Non-Structural BMPs, maintenance issues are of a different nature and extent, when contrasted with the more specific Chapter 6 Structural BMPs. Typically, the designated open space may be conveyed to the municipality, although most municipalities prefer not to receive these open space portions, including all of the maintenance and other legal responsibilities associated with open space ownership. In the ideal, open space reserves ultimately will merge to form a unified open space system, integrating important conservation areas throughout the municipality. These open space segments may exist dispersed and unconnected. For those Pennsylvania municipalities that allow for and enable creation of homeowners associations or HOA's, the HOA may assume ownership of the open space. The HOA is usually the simplest solution to the issue.

In contrast to some of the other long-term maintenance responsibilities of a new subdivision and/or land development (such as maintenance of streets, water and sewers, play and recreation areas, and so forth), the maintenance requirements of "undisturbed open space" by definition should be minimal. The objective is conservation of the natural systems, including the natural or native vegetation, with little intervention and disturbance. Nevertheless, some legal responsibilities must be assumed and need to be covered.

### **Cost Issues**

Clustering is beneficial from a cost perspective in several ways. Development costs are decreased because of less land clearing and grading, less road construction (including curbing), less sidewalk construction, less lighting and street landscaping, potentially less sewer and water line construction, potentially less stormwater collection system construction, and other economies.

Clustering also reduces post construction costs. A variety of studies from the landmark *Costs of Sprawl* study and later updates have shown that delivery of a variety of municipal services such as street maintenance, sewer and water services, and trash collection are more economical on a per person or per house basis when development is clustered. Even services such as police protection are made more efficient when residential development is clustered.

Additionally, clustering has been shown to positively affect land values. Analyses of market prices of conventional development over time in contrast with comparable cluster developments (where size, type, and quality of the house itself is held constant) have indicated that clustered developments with their proximity to permanently protected open space increase in value at a more rapid rate than conventionally designed developments, even though clustered housing occurs on considerably smaller lots than the conventional residences.



*Figure 5.1-6. Woodland removal for steep slope development with retaining walls.*

### **Specifications**

Clustering is not a new concept and has been defined, discussed, and evaluated in many different texts, reports, references and sources detailed in the References for BMP 5.5.1

## BMP 5.4.2: Protect /Conserve/Enhance Riparian Areas



The Executive Council of the Chesapeake Bay Program defines a Riparian Forest Buffer as "an area of trees, usually accompanied by shrubs and other vegetation, that is adjacent to a body of water and which is managed to maintain the integrity of stream channels and shorelines, to reduce the impact of upland sources of pollution by trapping, filtering and converting sediments, nutrients, and other chemicals, and to supply food, cover, and thermal protection to fish and other wildlife."

<p style="text-align: center;"><b><u>Key Design Elements</u></b></p> <ul style="list-style-type: none"> <li>▪ Linear in Nature</li> <li>▪ Provide a transition between aquatic and upland environments</li> <li>▪ Forested under natural conditions in Pennsylvania</li> <li>▪ Serve to create a "Buffer" between development and aquatic environment</li> <li>▪ Help to maintain the hydrologic, hydraulic, and ecological integrity of the stream channel.</li> <li>▪ Comprised of three "zones" of different dimensions:             <ul style="list-style-type: none"> <li>▪ <b>Zone 1:</b> Adjacent to the stream and heavily vegetated under ideal conditions (Undisturbed Forest) to shade stream and provide aquatic food sources.</li> <li>▪ <b>Zone 2:</b> Landward of Zone 1 and varying in width, provides extensive water quality improvement. Considered the Managed Forest.</li> <li>▪ <b>Zone 3:</b> Landward of Zone 2, and may include BMPs such as Filter Strips.</li> </ul> </li> </ul>	<p style="text-align: center;"><b><u>Potential Applications</u></b></p> <p>Residential:            Commercial: Ultra Yes Yes            Urban: Industrial: Yes Yes                      Retrofit: Yes Yes            Highway/Road:</p>
	<p style="text-align: center;"><b><u>Stormwater Functions</u></b></p> <p>Volume Reduction: Medium            Recharge: Medium            Peak Rate Control: Low/Med.            Water Quality: Very High</p>
	<p style="text-align: center;"><b><u>Water Quality Functions</u></b></p> <p>TSS: Preventive            TP: Preventive            NO3: Preventive</p>

There are two components to Riparian Buffers to be considered in the development process:

1. Protecting, maintaining, and enhancing existing Riparian Forest Buffers.
2. Restoring Riparian Forest Buffers that have been eliminated or degraded by past practices.

BMP 5.4.2 focuses on protection, maintenance, and enhancement of existing Riparian Forest Buffers. Restoration of Riparian Forest Buffers is treated in Chapter 6 as a Structural BMP.

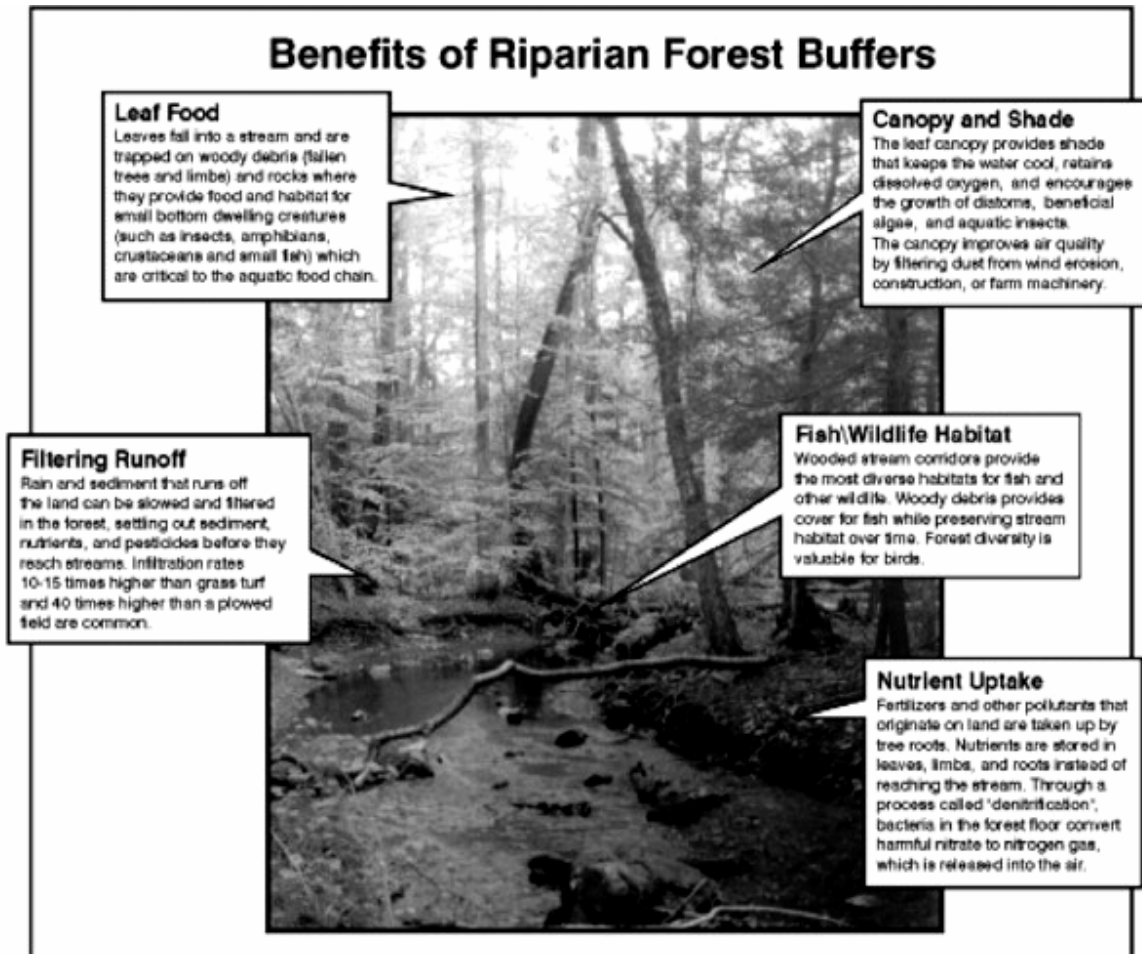


Figure 5.2-1. Riparian buffer zones support various ecological functions.

### Detailed Stormwater Functions

Riparian Corridors are vegetated ecosystems along a waterbody that serve to buffer the waterbody from the effects of runoff by providing water quality filtering, bank stability, recharge, rate attenuation and volume reduction, and shading of the waterbody by vegetation. Riparian corridors also provide habitat and may include streambanks, wetlands, floodplains, and transitional areas. Functions can be identified and sorted more specifically by Zone designation:

**Zone 1:** Provides stream bank and channel stabilization; reduces soil loss and sedimentation/nutrient and other pollution from adjacent upslope sheet flow; roots, fallen logs, and other vegetative debris slow stream flow velocity, creating pools and habitat for macroinvertebrates, in turn enhancing biodiversity; decaying debris provides additional food source for stream-dwelling organisms; tree canopy shades and cools water temperature, critical to sustaining certain macroinvertebrates, as well as critical diatoms, which are essential to support high quality species/cold water species. Zone 1 functions are essential throughout the stream system, especially in 1st order streams.

**Zone 2:** Removes, transforms, and stores nutrients, sediments, and other pollutants flowing as sheet flow as well as shallow sub-surface flow. A healthy Zone 2 has the potential to remove substantial quantities of excess nitrates through root zone uptake. Nitrates customarily can be significantly elevated when adjacent land uses are agricultural or urban/suburban. Healthy vegetation in Zone 2 slows surface runoff while filtering sediment and particulate bound phosphorus. Total nutrient removal is facilitated through a variety of complex processes: long-term nutrient storage through microbe uptake, denitrification through bacterial conversion to nitrogen gases and additional microbial degradation processes.

**Zone 3:** Provides the first stage in managing upslope runoff so that runoff flows are slowed and evenly dispersed into Zone 2. Some physical filtering of pollutants may be accomplished in Zone 3 as well as some limited amount of infiltration.

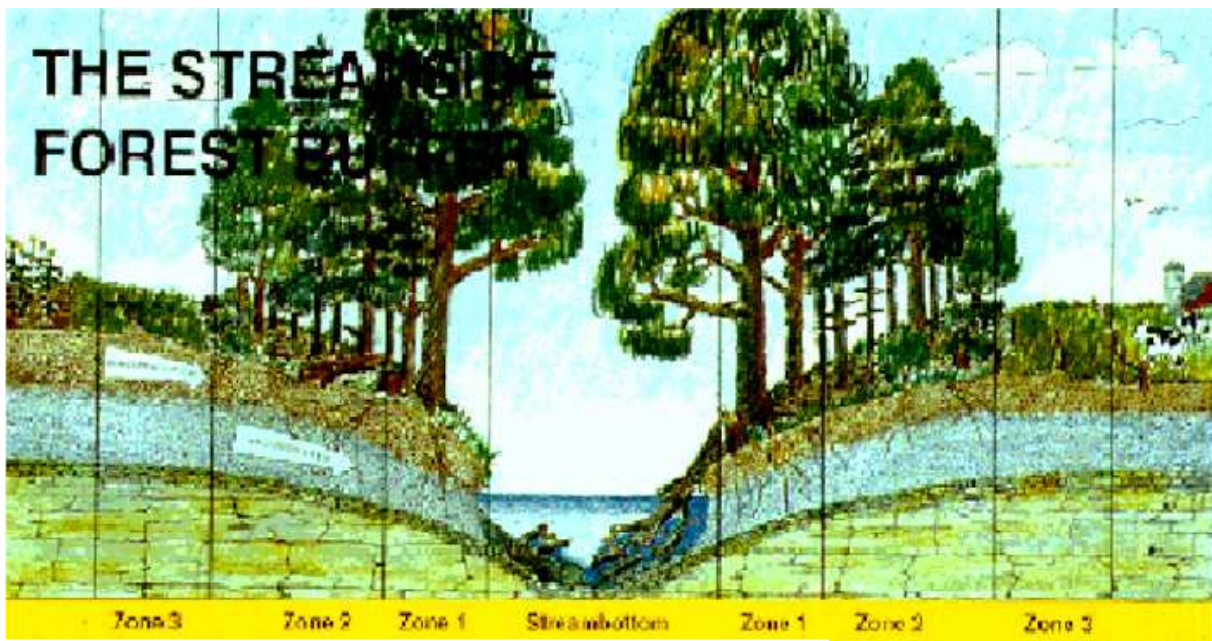


Figure 5.2-2. Riparian buffer zones (DJ Welsh, 1991).

### Design Considerations/Variations

Although this manual refers frequently to the Chesapeake Bay Program's Riparian Handbook, many different sources of guidance have been developed in recent years. Not all of these are exactly comparable in terms of their recommendations and specifications. To some extent these variations relate to different land use development contexts.

Riparian Forest Buffer Zone widths should be adjusted according to site conditions and type of upslope development. Variation in standards (see Specifications below) should vary with the function to be performed by the forested buffer. In undisturbed forested areas where minimal runoff is expected to be occurring, standards can be made more flexible than in agricultural contexts where large quantities of natural vegetation have been removed and significant quantities of runoff are expected. In addition to factors related to technical need, practical and political factors also must be considered. In urbanized settings where hundreds, if not thousands of small lots may abut riparian areas and already intrude into potential forested buffer zones, buffer standards must be practicable.

Lastly, confusion has emerged between the concept of floodplain and riparian forest buffer. In many cases, mapped and delineated floodplain may overlap and even largely coincide with riparian forest buffer zones. On the other hand, mapped 100-year floodway/floodplain may not coincide with the forest buffer due to either very steep topography or very moderate slopes. A second important clarification is that floodplain ordinances typically manage use to prevent flood damage, which contrasts to riparian forest buffer regulation which manages clearing and grading actions in the zones, specifically for environmental reasons.

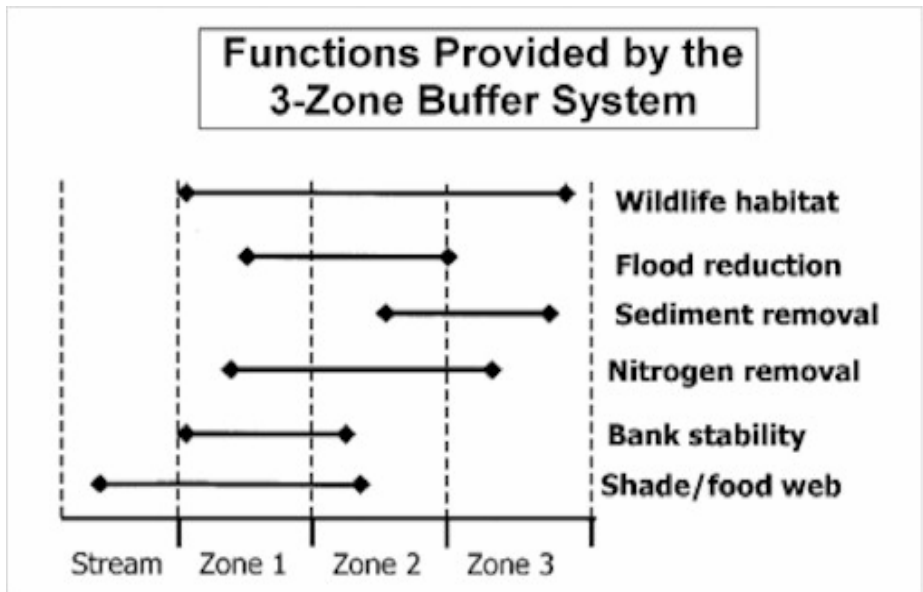


Figure 5.2-3. Riparian buffer zone functions.

### Construction Issues

Riparian Forest Buffer Protection should be defined and included in municipal ordinances, including both the zoning ordinance and subdivision and land development ordinance (SALDO). The Riparian Forest Buffer should be defined and treated from the initial stages of the land development process, similar to floodplain, wetland or any other primary conservation value. It is the municipality's responsibility to determine a fair and effective riparian forest buffer program, balancing the full range of water resource and watershed objectives along with other land use objectives. A fair and effective program should evolve for all municipal landowners and stakeholders. State-supported River Conservation Plans, Act 167 Stormwater Management Plans, and other planning may contribute to this effort.

Whether a respective municipality has included riparian forest buffers in its ordinances or not, landowners/developers/applicants should include riparian forest buffers in their site plans from the initiation of the site planning process. If standards and guidelines have been set forth by the municipality or by other relevant planning group, these standards and guidelines should be followed. If none of these exist, standards recommended in this manual should be followed.

The ease of accommodating a riparian forest buffer can be expected to vary based on intensity of land use, zoning at the site and size of the parcel. Holding all other factors constant, as site size decreases, the challenges posed by riparian zone accommodation can be expected to increase. As sites become extremely small, reservation of site area for riparian forest buffer may become problematic, thereby requiring riparian forest buffer modification in order to accommodate a reasonable building program for the site. Zoned land use intensity is another factor to be considered. As this intensity increases and specifications for maximum building area and impervious area and total disturbed area are allowed to grow larger, reserving site area for the riparian forest buffer becomes more challenging. Riparian forest buffer programs need to be sensitive to these constraints.



All of these factors should be reviewed and integrated by the municipality as the riparian forest buffer program is being developed.

### **Cost Issues**

Costs of riparian forest buffer establishment are not significant, defined in terms of direct development. In these cases, costs can be reasonably defined as the lost opportunity costs of not being able to use acreage reserved for the riparian forest buffer in the otherwise likely land use. A likely land use might be defined in terms of zoned land use. Depending upon the zoning category provisions and the degree to which a riparian forest buffer's Zone 1 or Zone 2 or Zone 3 might be able to be included as part of a land development plan or as part of yard provisions for lots in a residential subdivision acreage included within the riparian forest buffer may or may not be able to be included as part of the development. If riparian acreage must be totally subtracted, then it's fair value should be assessed as a cost. If riparian forest buffers can be credited as part of yards (though still protected), then that acreage should not be considered to be a cost. Any one-time capital cost can be viewed alternatively as an annualized cost.

To the extent that the riparian forest buffer coincides with the mapped and regulated floodplain, where homes and other structures and improvements should not be located, then attributing any lost opportunity costs exclusively to riparian forest buffers is not reasonable. The position can be argued that any riparian forest buffer area, which is included within floodplain limits, should not be double-counted as a riparian forest buffer cost. Alternatively, any riparian forest buffer area that extends beyond the floodplain could be assigned a cost.

Lost opportunity costs can be expected to vary depending upon land use. Alternative layouts, including reduced lot size configurations, may be able to provide the same or close to the same number of units and the same level of profitability.

Over the long-term, some modest costs are required for periodic inspection of the riparian forest buffer plus modest levels of maintenance. Generally, the buffers require very little in the way of operating and maintenance costs.

If objective cost-benefit analysis were to be undertaken on most riparian forest buffers, results would be quite positive, demonstrating that the full range of environmental and non-environmental benefits substantially exceeds costs involved. Protection of already existing vegetated areas located adjacent to streams, rivers, lakes, and other waterways is of tremendous importance, given their rich array of functional benefits.

### **Stormwater Management Calculations**

Stormwater calculations in most cases for Volume Control and Recharge and Peak Rate will not be affected dramatically. See Chapter 8 for more discussion relating to Water Quality.

## Specifications

The Chesapeake Bay Program's Riparian Handbook provides an in-depth discussion of establishing the proper riparian forest buffer width, taking into consideration:

1. existing or potential value of the resource to be protected,
  2. site, watershed, and buffer characteristics,
  3. intensity of adjacent land use, and
  4. specific water quality and/or habitat functions desired.
- (Handbook, p. 6-1)

At the core of the scientific basis for riparian forest buffer establishment are a variety of site-specific factors, including: watershed condition, slope, stream order, soil depth and erodibility, hydrology, floodplains, wetlands, streambanks, vegetation type, and stormwater system, all of which are discussed in the Handbook. Positively, this body of scientific literature has expanded

tremendously in recent years and provides excellent support for effective buffer management. The downside is that this scientific literature now exceeds quick and easy summary. Fortunately, this Handbook and many additional related references are available online without cost (given the comprehensiveness of the Handbook itself, it is recommended that the reader start here).

**Zone 1:** Also termed the “streamside zone,” this zone “...protects the physical and ecological integrity of the stream ecosystem. The vegetative target is mature riparian forest that can provide shade, leaf litter, woody debris, and erosion protection to the stream. The minimum width is 25 feet from each streambank (approximately the distance of one or two mature trees from the streambank), and land use is highly restricted....” (Handbook, p. 11-8)

**Zone 2:** Also termed the “middle zone,” this zone “...extends from the outward boundary of the streamside zone and varies in width depending on stream order, the extent of the 100-year flood plain, adjacent steep slopes, and protected wetland areas. The middle zone protects key components of the stream and provides further distance between upland development and the stream. The minimum width of the middle core is approximately 50 feet, but it is often expanded based on stream order, slope of the presence of critical habitats, and the impact of recreational or utility uses. The vegetative target for this zone is also mature forest, but some clearing is permitted for stormwater management Best Management Practices (BMPs), site access, and passive recreational uses....” (Handbook, p. 11-8)

**Zone 3:** Also termed the “outer zone,” this zone “...is the ‘buffer’s buffer.’ It is an additional 25-foot setback from the outward edge of the middle zone to the nearest permanent structure. In many urban situations, this area is a residential backyard. The vegetative character of the outer zone is usually turf or lawn, although the property owner is encouraged to plant trees and shrubs to increase the total width

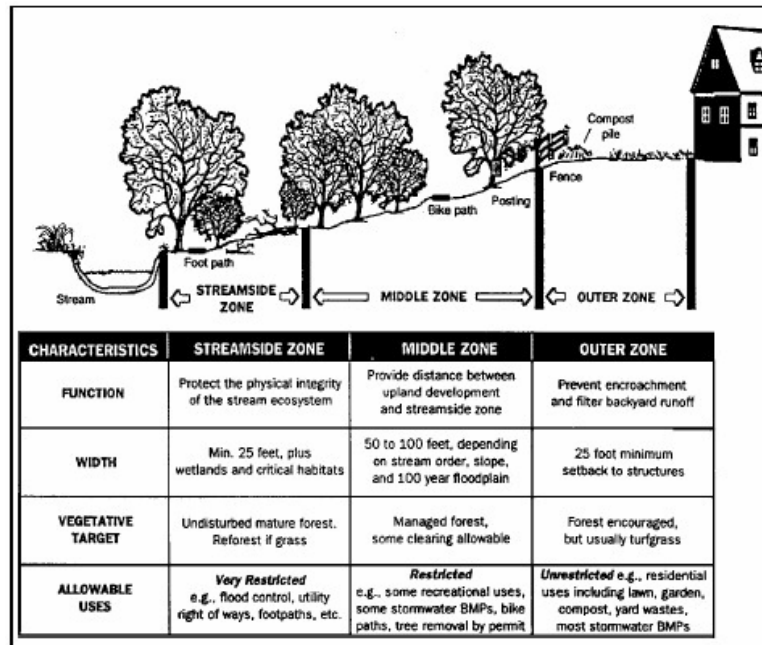


Figure 5.2-4. Three zone urban buffer system (Schueler, 1995 and Metropolitan COG, 1995).

of the buffer... The only significant restrictions include septic systems and new permanent structures.”  
(Handbook, p. 11-9)

The Handbook also provides more detailed specifications for riparian forest buffers (Appendix 1), as developed by the USDA's Forest Service.



## BMP 5.4.3: Protect/Utilize Natural Flow Pathways in Overall Stormwater Planning and Design



Identify, protect, and utilize the site's natural drainage features as part of the stormwater management system.

<p style="text-align: center;"><b><u>Key Design Elements</u></b></p> <ul style="list-style-type: none"> <li>▪ Identify and map natural drainage features (swales, channels, ephemeral streams, depressions, etc.)</li> <li>▪ Use natural drainage features to guide site design</li> <li>▪ Minimize filling, clearing, or other disturbance of drainage features</li> <li>▪ Utilize drainage features instead of engineered systems whenever possible</li> <li>▪ Distribute non-erosive surface flow to natural drainage features</li> <li>▪ Keep non-erosive channel flow within drainage pathways</li> <li>▪ Plant native vegetative buffers around drainage features</li> </ul>	<p style="text-align: center;"><b><u>Potential Applications</u></b></p> <p>Residential: Yes  Commercial: Yes  Ultra Urban: No  Industrial: Yes  Retrofit: Yes  Highway/Road: Yes</p>
<p style="text-align: center;"><b><u>Stormwater Functions</u></b></p> <p>Volume Reduction: Low/Med.  Recharge: Low  Peak Rate Control: Med./High  Water Quality: Medium</p>	<p style="text-align: center;"><b><u>Water Quality Functions</u></b></p> <p>TSS: 30%  TP: 20%  NO3: 0%</p>

## Description

Most natural sites have identifiable drainage features such as swales, depressions, watercourses, ephemeral streams, etc. which serve to effectively manage any stormwater that is generated on the site. By identifying, protecting, and utilizing these features a development can minimize its stormwater impacts. Instead of ignoring or replacing natural drainage features with engineered systems that rapidly convey runoff downstream, designers can use these features to reduce or eliminate the need for structural drainage systems. Naturally vegetated drainage features tend to slow runoff and thereby reduce peak discharges, improve water quality through filtration, and allow some infiltration and evapotranspiration to occur. Protecting natural drainage features can provide for significant open space and wildlife habitat, improve site aesthetics and property values, and reduce the generation of stormwater runoff. If protected and used properly, natural drainage features generally require very little maintenance and can function effectively for many years.



*Figure 5.3-1 Protect natural drainage features*

## Variations

Natural drainage features can also be made more effective through the design process. Examples include constructing slight earthen berms around natural depressions or other features to create additional storage, installing check dams within drainage pathways to slow runoff, and planting additional native vegetation.

## Applications

- Use buffers to treat stormwater runoff.

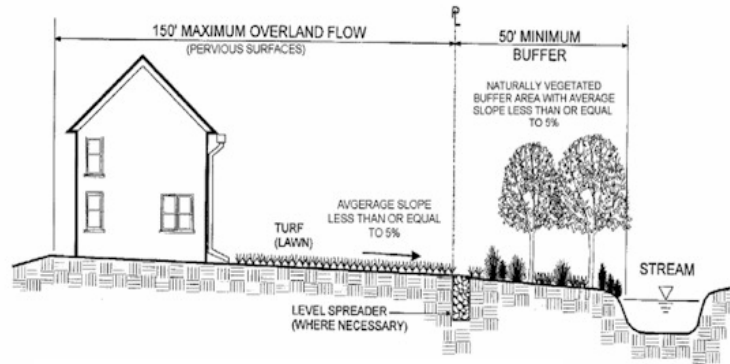


Figure 5.3-2 Section of buffer utilization

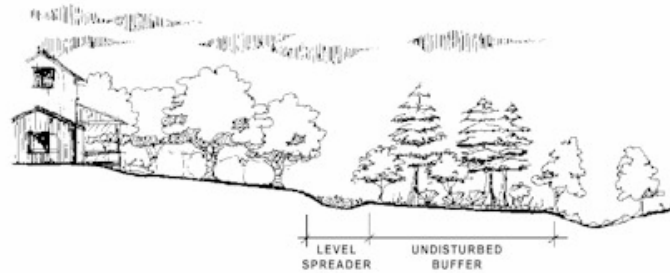


Figure 1.4.2-28 Use of a Level Spreader with a Riparian Buffer

Figure 5.3-3 Section of buffer utilization

- Use natural drainage pathways instead of structural drainage systems

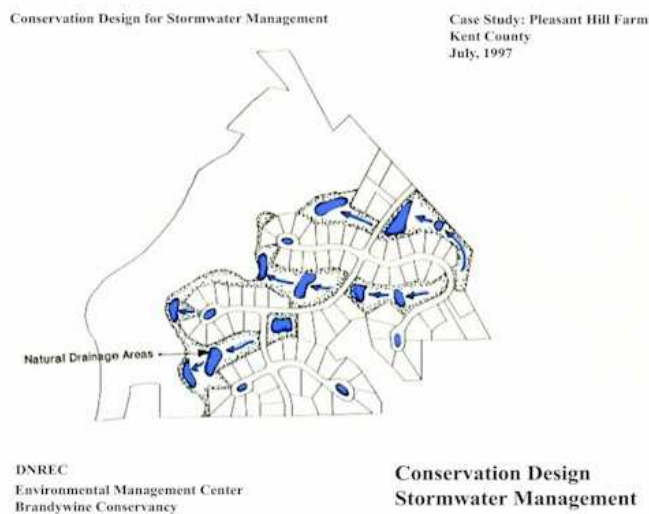


Figure 5.3-4 The natural surface can provide stormwater drainage pathways

- Use natural drainage features to guide site design



Figure 5.3-5 Natural drainage features can guide the design

- Others...



Figure 5.3-6 Natural surface depressions can temporarily store stormwater.

## Design Considerations

**1. IDENTIFICATION OF NATURAL DRAINAGE FEATURES.** Identifying and mapping natural drainage features is generally done as part of a comprehensive site analysis. This process is an integral part of site design and is the first step for many of the non-structural BMPs described in this Chapter.

**2. NATURAL DRAINAGE FEATURES GUIDE SITE DESIGN.** Instead of imposing a two-dimensional 'paper' design on a particular site, designers can use natural drainage features to steer the site layout. Drainage features can be used to define contiguous open space/undisturbed areas as well as road alignment and building placement. The design should minimize disturbance to natural drainage features and crossings of them. Drainage features that are to be protected should be clearly shown on



all construction plans. Methods for protection, such as signage and fencing, should also be noted on applicable plans.

**3. UTILIZE NATURAL DRAINAGE FEATURES.** Natural drainage features should be used in place of engineered stormwater conveyance systems wherever possible. Site designs should use and/or improve natural drainage pathways to reduce or eliminate the need for stormwater pipe networks. This can reduce costs, maintenance burdens, disturbance/earthwork related to pipe installation, and the size of other stormwater management facilities. Natural drainage features should be protected from any increased runoff volumes and rates due to development. The design should prevent the erosion and degradation of natural drainage features through the use of upstream volume and rate control BMPs. Level spreaders, erosion control matting, re-vegetation, outlet stabilization and check dams can also be used to protect natural drainage features, where appropriate.

**4. NATIVE VEGETATION.** Natural drainage pathways should be provided with native vegetative buffers and the features themselves should include native vegetation where applicable. If drainage features have been previously disturbed, they can be restored with native vegetation and buffers.

### **Detailed Stormwater Functions**

#### **Volume Reduction Calculations**

Protecting/utilizing natural drainage features can reduce the volume of runoff in several ways. Reducing disturbance and maintaining a natural cover can significantly reduce the volume of runoff through infiltration and evapotranspiration. This will be self-crediting in site stormwater calculations through lower runoff coefficients and/or higher infiltration rates. Utilizing natural drainage features can reduce runoff volumes because natural drainage pathways allow infiltration to occur, especially during smaller storm events. Encouraging infiltration in natural depressions also reduces stormwater volumes. Employing strategies that direct non-erosive sheet flow onto naturally vegetated areas can allow considerable infiltration. See Chapter 8 for volume reduction calculation methodologies.

#### **Peak Rate Mitigation Calculations**

Protecting/utilizing natural drainage features can reduce the anticipated peak rate of runoff in several ways. Reducing disturbance and maintaining a natural cover can significantly reduce the runoff rate. This will be self-crediting in site stormwater calculations through lower runoff coefficients, higher infiltration rates, and longer times of travel. Using natural drainage features can lower discharge rates significantly by slowing runoff and increasing on-site storage.

#### **Water Quality Improvement**

Protecting/utilizing natural drainage features can improve water quality through filtration, infiltration, sedimentation, and thermal mitigation. See Chapter 8 for Water Quality Improvement methodologies.

### **Construction Issues**

1. At the start of construction, natural drainage features to be protected should be flagged/fenced with signage as shown on the construction drawings.
2. Non-disturbance and minimal disturbance zones should be strictly enforced.
3. Natural drainage features must be protected from excessive sediment and stormwater loads while their drainage areas remain in a disturbed state.

## **Maintenance Issues**

Natural drainage features that are properly protected/utilized as part of site development should require very little maintenance. However, periodic inspections and maintenance actions (if necessary) are important. Inspections should assess erosion, bank stability, sediment/debris accumulation, and vegetative conditions including the presence of invasive species. Problems should be corrected in a timely manner. If native vegetation is being established it may require some support – watering, weeding, mulching, replanting, etc. – during the first few years. Undesirable species should be removed and desirable replacements planted if necessary.

Protected drainage features on private property should have an easement, deed restriction, or other legal measure to prevent future disturbance or neglect. DEP has worked with the Pennsylvania Land Trust Association (PALTA) to develop an easement template with guiding commentary for permanently protecting forest riparian buffers. The model is tailored to protect a relatively narrow ribbon of land along a waterway or lake. Presumably, the riparian buffers will most often comprise lands of severely limited development potential and the landowner will not be seeking a charitable federal income tax deduction.

In preparing the model, it was also assumed that landowners would be receiving no more than a nominal sum for placing the restrictive covenants on their land. To promote landowner donation, the model was drafted to be as brief as possible while providing core protections to forest riparian buffers. The model with guiding commentary is available at [http://conserveland.org/model\\_documents/#riparian](http://conserveland.org/model_documents/#riparian). PALTA is now offering landowners who use this model a grant of up to \$6000 to cover associated costs such as attorney's fees.

## **Cost Issues**

Protecting/utilizing natural drainage features generally results in a significant construction cost savings. Protecting these features results in less disturbance, clearing, earthwork, etc. and requires less re-vegetation. Utilizing natural drainage features can reduce the need and size of costly, engineered stormwater conveyance systems. Together, protecting and utilizing drainage features can reduce or eliminate the need for stormwater management facilities (structural BMPs), lowering costs even more.

Design costs may increase slightly due to a more thoughtful, site-specific design.

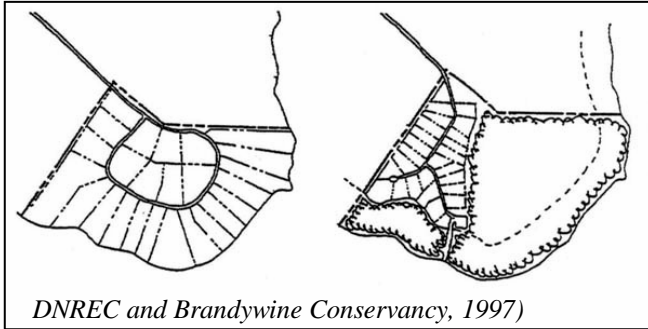
## **Specifications**

Not applicable

## **5.5 Cluster and Concentrate**



# BMP 5.5.1: Cluster Uses at Each Site; Build on the Smallest Area Possible



As density is held constant, lot size is reduced, disturbed area is decreased, and undisturbed open space is increased.

<p style="text-align: center;"><b><u>Key Design Elements</u></b></p> <ul style="list-style-type: none"> <li>▪ Reduce total site disturbance/total site maintenance and increase undisturbed open space by clustering proposed uses on a total site basis through moving uses closer together (i.e., reducing lot size) and/or through stacking uses (i.e., building vertically), even as amount of use (i.e., gross density) is held constant as per existing zoning (or any other gross density determination). As density is held constant (Example A), lot size is reduced, disturbed area decreases, and undisturbed open space increases (Example B).</li> <li>▪ Per lot values/prices may decline marginally; however, development costs also decrease.</li> <li>▪ Cluster provisions may/may not be allowed by municipal zoning; if no zoning exists, ability to cluster may not be clear (lacking zoning, has the municipality in any way set standards for site uses, gross densities of these uses, etc.?).</li> <li>▪ Pending answers to above questions, have lot sizes been reduced to the minimum, given proposed uses? Given existing ordinance provisions? Given other development feasibility factors such as public water/sewer vs. on-site water and sewer and others?</li> <li>▪ Is the applicant maximizing clustering as much as possible legally?</li> <li>▪ Is the applicant maximizing clustering functionally within municipal ordinance limits?</li> </ul>	<p style="text-align: center;"><b><u>Potential Applications</u></b></p> <p style="text-align: center;">Residential: Yes  Commercial: Yes*  Ultra Urban: Limited  Industrial: Limited  Retrofit: Yes  Highway/Road: No</p> <p><small>*Depending on site size, constraints and other factors.</small></p> <hr/> <p style="text-align: center;"><b><u>Stormwater Functions</u></b></p> <p style="text-align: center;">Volume Reduction: Very High  Recharge: Very High  Peak Rate Control: Very High  Water Quality: Very High</p> <hr/> <p style="text-align: center;"><b><u>Water Quality Functions</u></b></p> <p style="text-align: center;">TSS: Preventive  TP: Preventive  NO3: Preventive</p>
---	--

## Description

See Key Design Elements.

## Variations

- Clustering can be mandated by a municipality as the so-called by-right provision of the zoning district, rather than allowed as a zoning option.
- Density bonus with reduced lot size. In some cases, when lot size is reduced, gross density allowed at the site may be increased, in order to balance what might be lesser values/profitability from smaller lots (Example C). Extent of bonus density is variable, becoming larger as lot size reduction increases (net effect is to always reduce net disturbed area); density bonuses may be made to increase as total undisturbed open space provisions are increased (e.g., for every 10 percent increase in undisturbed open space being provided, density is allowed to increase by 5 percent, and so forth; Example D).
- Extreme Clustering in the form of the Growing Greener 4-Step Design Process which includes: Step 1: Map of Primary and Secondary Conservation Areas; Step 2: Map of Potential Development Area with Yield Plan, calculated as per allowed gross density; Step 3: Map of Street and Trail Connection; Step 4: Map of Lot Lines

## Applications

- Residential Clustering:
  - Example A, shown in Figure 5.4-1: The kind of subdivision most frequently created in Pennsylvania is the type which blankets the development parcel with house lots and pays little attention to designing around the special features of the property. In this example, the house placement avoids the primary conservation areas, but disregards the secondary conservation features. Such a sketch can provide a useful estimate of a site's capacity to accommodate new houses at the base density allowed under zoning- and is therefore known as a "Yield Plan."



Figure 5.4-1 Conventional Development, (Source: *Growing Greener: Putting Conservation Into Local Codes*. Natural Lands Trust, Inc., 1997)

- Example B, shown in Figure 5.4-2: Density-neutral with Pre-existing Zoning; 18 lots; Lot Size Range: 20,000 to 40,000 sq. ft.; 50% undivided open space
- Example C, shown in Figure 5.4-3: Enhanced Conservation and Density; 24 lots; Lot Size Range: 12,000 to 24,000 sq. ft.; 60% undivided open space
- Example D, shown in Figure 5.4-4: Hamlet or Village; 36 lots; Lot Size Range: 6,000 to 12,000 sq. ft.; 70% undivided open space

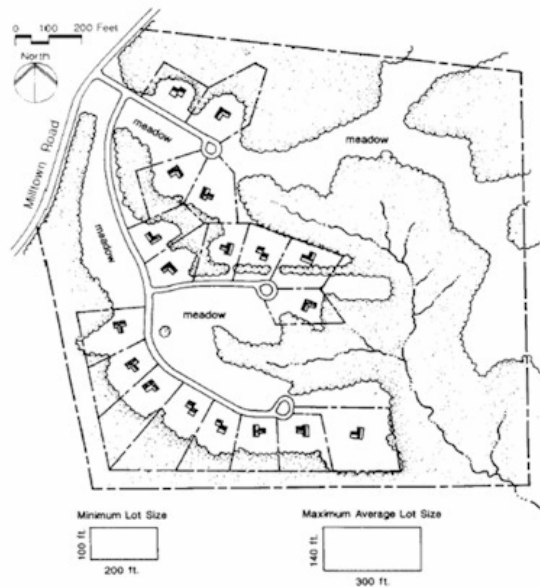


Figure 5.4-2 Clustered Development, (Source: Growing Greener: Putting Conservation Into Local Codes. Natural Lands Trust, Inc., 1997)

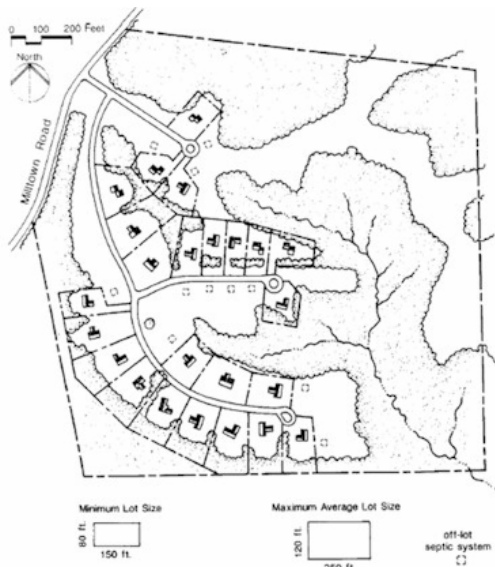


Figure 5.4-3 Modest Density Bonus, (Source: Growing Greener: Putting Conservation Into Local Codes. Natural Lands Trust, Inc., 1997)



Figure 5.4-4 Hamlet or Village, (Source: Growing Greener: Putting Conservation Into Local Codes. Natural Lands Trust, Inc., 1997)

- Non-Residential Clustering:
  - Conventional Development
  - Preferred Vertical Neo-Traditional Development

## Design Considerations

### Objectives:

- Maximize open space, especially when it includes sensitive areas (primary and secondary).
- Maximize access to open space.
- Maximize sense of place design qualities.
- Balance infrastructure needs (sewer, water, roads, etc.)

Clustering should respond to a variety of site considerations. This BMP discussion assumes that proper and effective work has been undertaken by the municipality to determine the proper site by site land uses and the proper densities/intensities of these land uses. The question is then: *how can X amount of Y uses be best clustered at a particular site?*

## Detailed Stormwater Functions

Clustering, as defined here, is self-reinforcing. Clustering reduces total impervious areas, including street lengths and total paved area and is likely to link with other BMPs, as defined in this Chapter, including reduced imperviousness, reduced setbacks, reduced areas for drives and walkways, and so forth. All of this directly translates into reduced volumes of stormwater being generated and reduced peak rates of stormwater being generated, thereby benefiting stormwater planning. Additionally, clustering translates into reduced disturbance and increased preservation of the natural landscape and natural vegetative land cover, which further translates into reduced stormwater runoff, volume and peak. To the extent that this clustering BMP also involves increased vertical development, net site roof area and impervious area is reduced, holding number of units and amount of square footage of a use constant. In all cases, density bonuses, if utilized, should be scrutinized to make sure that additional density allowed is more than balanced by additional open space being provided, including further reductions in street lengths, other impervious surfaces, other disturbed areas, and so forth.

Water quality is affected by non-point source pollutant load from impervious areas, as well as the pollutant load from the newly created maintained landscape, much of which is soluble in form (especially fertilizer-linked nitrogen forms). Clustering, alone and when combined with other Chapter 5 Non-Structural BMPs, minimizes impervious areas and the pollutant loads related to these impervious areas. Similarly, clustering minimizes pollutant loads from lawns and other mowed areas. After Chapter 5 BMPs are optimized, “unavoidable” stormwater is then directed into BMPs as set forth in Chapter 6, to be properly treated. Chemical pollution prevention accomplished through Non-Structural BMPs is especially important because Structural BMPs remain poor performers in terms of mitigating/removing soluble pollutants that are especially problematic in terms of this pervious maintained landscape. See Appendix A for additional documentation of the water quality benefits of clustering.

See Chapter 8 for volume reduction calculation work sheets, peak rate reduction calculation work sheets, and water quality mitigation work sheets.

## Construction Issues

Application of this BMP clearly is required from the start of the site planning and development process. Not only must the site owner/builder/developer embrace BMP 5.5.1 Cluster Uses at Each Site from the



start of the process, the respective municipal officials must have included clustering in municipal codes and ordinances, as is the case with so many of these Chapter 5 Non-Structural BMPs. Any areas to be protected from development must be clearly marked in the field prior to the beginning of construction.

## **Maintenance Issues**

As with all Chapter 5 BMPs, maintenance issues are of a different nature and extent than the more specific Chapter 6 Structural BMPs. Typically, the primary issue is “who takes care of the open space?” Legally, the designated open space may be conveyed to the municipality, although most municipalities prefer not to receive these open space portions, including all of the maintenance and other legal responsibilities associated with open space ownership. Ideally, open space reserves will merge to form a unified open space system, integrating important conservation areas throughout the municipality and beyond. In reality, these open space segments may exist dispersed and unconnected for a considerable number of years. For those Pennsylvania municipalities that allow for and enable creation of homeowners associations or HOA’s, the HOA, may assume ownership of the open space. The HOA is usually the simplest solution to the “who takes care of the open space” question.

In contrast to some of the other long-term maintenance responsibilities of a new subdivision and/or land development (such as maintenance of streets, water and sewers, play and recreation areas, etc.), the maintenance requirements of “undisturbed open space” should be minimal. The objective here is conservation of the natural systems already present, with minimal intervention and disturbance. Nevertheless, invariably some legal responsibilities must be assumed and need to be covered.

## **Cost Issues**

Clustering is beneficial from a cost perspective in several ways. Costs to build a single-family residential development is less when clustered than when not clustered, holding the home type and all other relevant infrastructure constant. Costs are decreased because of less land clearing and grading, less road construction (including curbing), less sidewalk construction, less lighting and street landscaping, potentially less sewer and water line construction, potentially less stormwater collection system construction, and similar savings.

Clustering also reduces post construction costs. A variety of studies from the landmark *Costs of Sprawl* study and later updates have shown that delivery of a variety of municipal services such as street maintenance, sewer and water services, and trash collection are more economical on a per person or per house basis when development is clustered. Even services such as police protection are made more efficient when residential development is clustered.

Additionally, clustering has been shown to positively affect land values. Analyses of market prices over time of conventional development in contrast with comparable residential units in clustered developments have indicated that clustered developments with their proximity to permanently protected open space increase in value at a more rapid rate than conventionally designed developments, even though clustered housing occurs on considerably smaller lots than the conventional residences.

## **Specifications**

Clustering is not a new concept and has been defined, discussed, and evaluated in many different texts, reports, references, sources, as set forth below.

## References

- Arendt, Randall. Fall, 1991. "Cluster Development, A Profitable Way to Some Open Space." In *Land Development*.
- Arendt, Randall. 1994. *Rural by Design*. Washington D.C.: Planners Press.
- Brandywine Conservancy, Environmental Management Center. 2003. *Transfer of Development Rights: A Flexible Option for Redirecting Growth in Pennsylvania*. Chadds Ford, PA.
- Chesapeake Bay Program and Redman/Johnston Associates. 1997. *Beyond Sprawl: Land Management Techniques to Protect the Chesapeake Bay, A Handbook for Local Governments*.
- Delaware Department of Natural Resources and Environmental Control and the Brandywine Conservancy. 1997. *Conservation Design for Stormwater Management: A Design Approach to Reduce Stormwater Impacts from Land Development*. Dover, DE
- Delaware Riverkeeper. 2001. *Stormwater Runoff: Lost Resource of Community Asset?* Washington Crossing, PA
- Gottsegen, Amanda Jones. 1992. *Planning for Transfer of Development Rights: A Handbook for New Jersey Municipalities*. Burlington County Board of Chosen Freeholders.
- Greenbelt Alliance. 1996. "Factsheet: Urban Growth Boundaries."
- Hampton Roads Planning District Commission, 1992. *Vegetative Practices for Nonpoint Source Pollution Prevention Management*.
- Herson-Jones, Lorraine M. 1995. *Riparian Buffer Strategies for Urban Watersheds*. Metropolitan Washington Council of Governments.
- Lincoln Institute of Land Policy. 1995. *Alternatives to Sprawl*. Washington DC.
- Maryland Office of Planning. 1995. *Managing Maryland's Growth: Transfer of Development Rights*.
- Mauer, George. 1996. *A Better Way to Grow*. Chesapeake Bay Foundation.
- National Association of Home Builders. 1982. *Cost Effective Site Planning*. Washington D.C.
- Pennsylvania Environmental Council. 1992. *Guiding Growth: Building Better Communities and Protecting our Countryside, A Planning and Growth Management Handbook for Pennsylvania Municipalities*. Philadelphia, PA
- Porter, Douglas R. et al. 2000. *The Practice of Sustainable Development*. The Urban Land Institute. Washington, D.C.
- Report of the Pennsylvania 21<sup>st</sup> Century Commission, 1998.
- Regional Plan Association and New York City Department of Environmental Protection, 1996. *Managing Watersheds: Combining Water Quality Protection and Community Planning*. New York, NY.

Schueler, Thomas R. and Heather K. Holland. 2000. *The Practice of Watershed Protection: Techniques for Protecting our Nation's Streams, Lakes, Rivers and Estuaries*. Center for watershed Protection Ellicott City, MD

Terrene Institute and the US Environmental Protection Agency. 1996. *A Watershed Approach to Urban Runoff: Handbook for Decisionmakers*. Washington DC.

US Environmental Protection Agency. 1993. *Guidance Specifying Management Measures for Sources of Nonpoint Pollution in Coastal Waters* 840-B-92-002.



## BMP 5.5.2: Concentrate Uses Area wide through Smart Growth Practices

---

On a municipal, multi-municipal or areawide basis, use of "smart growth" planning techniques, including neo-Traditional/New Urban planning principles, to plan and zone for concentrated development patterns can accommodate reasonable growth and development. These practices direct growth to areas or groups of parcels in the municipality that are most desirable and away from areas or groups of parcels that are undesirable. BMP 5.5.2 can be thought of as Super Clustering that transcends the reality of the many different large and small parcels that exist in most Pennsylvania municipalities. Clustering parcel by parcel simply cannot accomplish the growth management that is so essential to conserve special environmental and cultural values and protect special sensitivities. These smart growth techniques include but are not limited to, transfer of development rights (TDR), urban growth boundaries, effective agricultural zoning, purchase of development rights (PDR) by municipalities, donation of conservation easements by owners, limited development and bargain sales by owners, and other private sector landowner options. "Desirability" is defined in terms of environmental, historical and archaeological, scenic and aesthetic, "sense of place," and quality of life sensitivities and values.

<p style="text-align: center;"><b><u>Key Design Elements</u></b></p> <ul style="list-style-type: none"> <li>▪ Establish baseline growth and development context for the municipality or multi-municipal area (how much of what by when and where, using decade increments, plus ultimate build out).</li> <li>▪ On macro level (defined as municipality-wide, multi-municipality-wide, areawide), define criteria for growth "desirability" (opportunities) and "undesirability" (constraints) on a multi-site and/or municipality-wide and/or areawide basis.</li> <li>▪ Apply these "desirability" and "undesirability" criteria.</li> <li>▪ Contrast baseline growth and development (first step) with third step; highlight problems.</li> <li>▪ Apply smart growth techniques as needed to re-form "business as usual" future to max out "desirability" and "undesirability" performance. Techniques include: transfer of development rights (TDR), urban growth boundaries, effective agricultural zoning, purchase of development rights (PDR), donation of conservation easements by owners, limited development and bargain sales by owners, and other private sector landowner options.</li> </ul>	<p style="text-align: center;"><b><u>Potential Applications</u></b></p> <p style="text-align: center;">Residential: Yes  Commercial: Yes  Ultra Urban: Yes  Industrial: Yes  Retrofit: Yes  Highway/Road: Limited</p> <hr/> <p style="text-align: center;"><b><u>Stormwater Functions</u></b></p> <p style="text-align: center;">Volume Reduction: Very High  Recharge: Very High  Peak Rate Control: Very High  Water Quality: Very High</p> <hr/> <p style="text-align: center;"><b><u>Water Quality Functions</u></b></p> <p style="text-align: center;">TSS: Preventive  TP: Preventive  NO3: Preventive</p>
--	--

## Variations

Because of the broadness of this BMP and its macro scale, variations in this BMP can be substantial. Variations include: 1) how areas deemed to be desirable for growth are defined, whether clusters, hamlets, villages, towns and/or cities; 2) how areas deemed undesirable for growth are defined (conserving natural resources, agricultural lands and other vital resources); and 3) how any of this is made to happen and what blend of smart growth techniques can be applied (where and when) to implement 1 and 2.

### 1. Defining Desirable Growth – Opportunities for Growth: Clusters, Hamlets, Villages, Towns and Cities

The vision for growth and development can take many different forms and can vary substantially depending upon the respective municipality, group of municipalities, or area. Rural areas (Figure 5.5-1) striving to preserve their rural character can concentrate development through adherence to building onto or even creating Hamlets and Villages. If adjacent communities exist, development can be directed into the town or at the town edge (Figure 5.5-2). Clustering (see BMP 5.5.1) on a site-by-site basis is superior from a site perspective but yields a pattern that is less than optimal from a multi-site or area wide perspective (Figure 5.5-3). However, this overall pattern is vastly preferable to the business as usual approach across many different sites comprising the entire area (Figure 5.5-4).



*Figure 5.5-1 Rural landscape of Pennsylvania*

Areas already developed and urbanized are likely to define appropriate in-fill development and re-development at higher densities. Multiple community planning sources with specific community building standards and specifications are available for reference. The importance of careful definition of growth zones and the performance standards that define these growth zones cannot be overemphasized. Often this BMP has been driven by environmental conservation objectives such as saving the undesirable growth areas (Sending Zones in TDR parlance) as discussed below but every bit as much care must be taken in defining and planning the desirable growth areas (Receiving Zones).



*Figure 5.5-2 Use of TDR to protect rural landscapes and direct development into the Town or Town Edge*



*Figure 5.5-3 Site clustering provides a partial open space network, though less than that provided by TDR*



*Figure 5.5-4 Large lot zoning ignores natural and cultural resource values.*

## **2. Defining Undesirable Growth Areas – Constraints: High Value Watershed Areas, Agricultural Areas, Eco-Sensitive Habitat Areas, Headwaters, and Stream Designations**

Criteria used by a municipality or area for managing development may be expected to vary to some extent. Municipalities may include special watershed areas, which have Pennsylvania Code Chapter 93 Special Protection Waters designation (Exceptional Value and High Quality), as well as critical headwater (first order streams) portions of watersheds. Source Water Protection zones may exist, including areas of especially important groundwater recharge, or habitat areas where the Pennsylvania Natural Diversity Inventory (PNDI) indicates especially important species presence. Also, important wetlands, floodplains and other natural features may exist. Prime Agricultural Lands and Agricultural Security Districts may be deserving of conservation. Areas may be especially sensitive due to rugged topography or steep slopes. Areas may be sensitive due to richness of historical and archaeological and even scenic values. All of these important values are likely to extend well beyond individual parcel boundaries and require smart growth area wide growth management techniques.

## **3. Mixing and Matching Smart Growth Techniques: Public and Private**

If a municipality consists of only a handful of enormous parcels where BMP 5.5.1 Clustering can work together to achieve the areawide “desirable growth” and “undesirable growth” patterns for the entire municipality as described above, BMP 5.5.2 would be made unnecessary. Such is usually not the case. A municipality may decide to use all or most of the smart growth techniques discussed here. A municipality may decide that “less is more” and try to achieve its objectives with the most simple growth management program possible, using the fewest techniques. The blend of public techniques versus private techniques is also important. Most of what is involved here entails public sector management action, such as zoning ordinance provisions. A few municipalities in Pennsylvania (West Marlborough, Chester County) have achieved municipality-wide success through private landowner actions, such as voluntary donation of conservation easements to conservancies and land trusts.

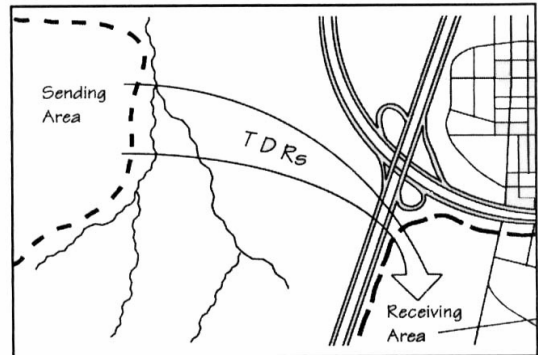
The optimal blend of smart growth techniques is not easily determined. Each technique has pros and cons, in terms of technical effectiveness, ease of implementation, political and socioeconomic implications, and integration with the local culture. Municipalities may decide to hire a local planning consultant (contact the Pennsylvania Planning Association for additional references), or may decide to consult with a free or low cost information resource such as the Pennsylvania Environmental Council or 10,000 Friends of Pennsylvania. The direct state government agency contact is the Pennsylvania Department of Community and Economic Development. These organizations and agencies offer a variety of planning resources by providing information on smart growth techniques and their potential usefulness in any one particular municipal setting. The organizations’ respective websites should be consulted for more detailed information.



## Applications

### Transfer of Development Rights (TDR)

Transfer of Development Rights (TDR, see Figure 5.5-5) is allowed as an option in Pennsylvania under the Municipalities Planning Code. TDR creates an overlay (Sending Zone) in the zoning ordinance where property owners are allowed to sell development rights for properties where growth is deemed to be less than desirable for any number of reasons. In a second created overlay zone (Receiving Zone), these development rights that have been purchased may be used to increase development density, above the maximum baseline or conventional zoned density. TDR has been in existence for some years and has been used by a relatively small number of Pennsylvania municipalities, although it has been used more widely in New Jersey and several other states. Although TDR is created in the municipal zoning ordinance, all TDR transactions or transfers of development rights may occur within the private sector, between Sending Zone owners and Receiving Zone purchasers or developers. TDR has been used in Buckingham Township (Bucks County), West Bradford and West Vincent Townships (Chester County), Manheim and Warwick Townships (Lancaster County).

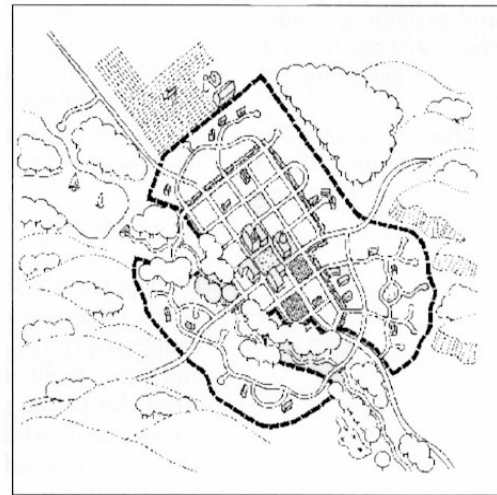


Source: Maryland Office of Planning

Figure 5.5-5 Example of Transfer of Development Rights

### Growth Boundaries:

Growth Boundaries (Urban Growth Boundaries, see Figure 5.5-6) are based on the concept that infrastructure such as public road systems and public water and wastewater treatment systems have a powerful growth inducing and growth shaping influence on an area wide basis. By controlling the location and timing of this infrastructure through municipal or public sector action, municipalities can encourage development in certain areas and discourage development in others. Growth Boundaries define where municipalities will directly and indirectly encourage, and even provide infrastructure services, significantly increasing zoned densities. Areas lacking such infrastructure services are zoned at significantly decreased densities. The State of Oregon has been a leading advocate of Growth Boundaries. Lancaster County for some years has been applying Growth Boundary principles in its comprehensive planning (go to their website to the annual Growth Tracking reports which document how their planning is achieving Growth Boundary objectives).



Source: Greenbelt Alliance

Figure 5.5-6 Example of Urban Growth Boundary

### Effective Agricultural Zoning:

Large lot zoning (usually defined as zoning that requires average lot size to be greater than 2 acres per lot) has been rejected by Pennsylvania courts as exclusionary and unacceptable. However, very large minimum lot size to maintain existing agricultural uses has been deemed to be acceptable by Pennsylvania courts and is being practiced throughout Pennsylvania, especially in intensive agricultural communities in southcentral Pennsylvania (e.g., multiple municipalities in Adams, Berks, Chester, Lancaster, York, etc.). Effective agricultural zoning may take the form of a specified mapped zoning category with a minimum lot size of 10, 15, 20, or 25 acres (this varies). Sliding scale agricultural

zoning is a popular variation, where additional lots to be created and subdivided are a function of the size of the total agricultural tract (though gross density remains very low). The intent is to allow a small number of lots to be created over time, possibly for family members or for agricultural workers, but to keep the functioning farms as intact as possible without residential subdivision or any other development intrusion. The concept here is that the so-called "highest and best use of the land" is agricultural use, which will be best maintained through protection of the farming community and through this very low-density zoning. Application of Agricultural Zoning has been restricted to areas where agriculture can be defined explicitly, typically in the presence of prime farmland soils, intensive agricultural activity, formation of Agricultural Security Districts, or other indicators of important agricultural activity. Obviously, this smart growth technique has limited application in terms of a growth management technique.

### **Purchase of Development Rights:**

Similar to TDR, the concept of Conservation Easements hinges on the notion that development rights for any particular property can be defined and separated from a property. These development rights can then be purchased and in a sense retired from the open market. The Pennsylvania Farmland Preservation Program, which purchases development rights from existing agricultural owners and allows farmers to continue their ownership and their agricultural activities, has become one of the most successful agricultural preservation programs in the country. This program is highly competitive and obviously limited to agricultural properties and contexts. The Farmland Preservation Program is a priority of the current administration, will continue to be funded, and has been reinforced in several counties with county-funded farmland preservation programs in order to stretch the state dollars.

Some counties (Bucks, Chester, Montgomery Counties) and municipalities (North Coventry, East Bradford, Pennsbury, Solebury, West Vincent and others) have enacted special open space and recreation acquisition programs. They are funded in various ways (bond issues, real estate taxes, small payroll taxes) to purchase additional county-owned and municipality-owned lands, for use as active and passive recreation as well as open space conservation. These efforts can be used in conjunction with TDR programs, whereby a municipality funds a revolving fund-supported land development bank which purchases development rights from vulnerable and high priority properties in Sending Zones. It later sells these development rights (Warwick Township in Lancaster County has done this) to Receiving Zone developers.

### **Conservation Easements (Donation and Purchase): Brandywine Conservancy, Natural Lands Trust, Western Pennsylvania Conservancy, Others**

Similar to TDR, the concept of Conservation Easements hinges on the notion that development rights for any particular property can be defined and separated from a property. These development rights can then be donated to an acceptable organization to support the public's health, safety and welfare, in the form of a conservation easement which restricts the owner's ability to develop the property in perpetuity, regardless of municipal zoning. Historically, a major incentive for these conservation easement donations has been the major tax benefits afforded such donations. Organizations such as the Brandywine Conservancy, Natural Lands Trust, the Western Pennsylvania conservancy and many others have protected thousands of acres of otherwise developable property in Pennsylvania through privately donated conservation easements, with absolutely no public expenditure of funds. Brandywine's 30,000 acres of conservation easements in the Brandywine Creek Watershed is an excellent case in point. Municipalities such as West Marlborough Township in Chester County have large portions of their jurisdictions permanently conserved as the result of this Conservation Easement program. Conservation Easements also can be purchased by a conservation organization or government agency. National organizations such as the Nature Conservancy, the Trust for Public Land, the Land Trust Alliance, and others are active in Pennsylvania and are excellent sources of technical information relating to this smart growth technique. In parts of Pennsylvania, these larger

organizations are helping fledgling local land trusts form and begin their important work of land conservation.

**Bargain Sale/Limited Development Options:**

A variation on the donation of development rights through conservation easements is a “bargain sale,” where a portion of the development rights value is donated (in the manner described above) but the property owner still enjoys a return on his/her property. In any number of development-pressured municipalities in Pennsylvania, fair market value for a large 100-acre farm to be developed as single-family residences or some other use may reach 2 or 3 million dollars. The owner, beyond tax benefits, may need a monetary settlement, though not in the order of 2 to 3 million dollars. In such cases, a defined “bargain sale” might be arranged if a source of funds can be located to provide a partial financial settlement for the owner. The owner benefits from an approved donation of the remainder of the value that can reduce the owner’s tax bill. The property is conserved.

A further variation would be a limited development option wherein a substantially reduced development program is developed which conserves much if not most of the property in question. An existing farmstead or homestead is retained and the property owner may even retain this farmstead/homestead. A much smaller number of lots surrounded by open space is carefully created; these lots typically command a considerably higher value than would be the case for a conventional subdivision. A large amount of open space is created and protected through a conservation easement, which may be donated as well, providing further tax benefit. The outcome is that the property owner, after taxes, may be almost as well off after a Limited Development approach to the property than would be the case with a complete conventional “as of right” approach to development. If the Limited Development concept has been prepared carefully, total property disturbance can be substantially reduced.

**Sustainable Watershed Management and Water-Based Zoning: Green Valleys Association and the Brandywine Conservancy**

**Design Considerations:**

Objectives for BMP 5.5.2 resemble BMP 5.5.1, although they must be understood as municipality-wide, rather than just site-wide:

- Maximize open space, especially sensitive areas (primary and secondary) and areas of special value.
- Maximize “sense of place” design qualities where growth is desirable.
- Balance infrastructure needs (sewer, water, roads, etc.) and use infrastructure to shape desirable growth

BMP 5.5.2 relies on application of smart growth techniques. The specific optimal blend of these smart growth techniques should respond to a variety of municipality characteristics and considerations. This BMP discussion assumes that proper and effective work has been undertaken by the municipality to determine the proper land uses and the proper densities/intensities of these land uses, municipality-wide. The question is then: how can these uses – this future development - be best planned within the municipality, achieving the best and most livable communities for the future, even as disruption to the natural landscape is minimized?

## Detailed Stormwater Functions

Concentrating growth, as defined here, is self-reinforcing from a stormwater management perspective – in terms of peak rate reduction, runoff volume reduction, and nonpoint source load reduction. Concentrating growth reduces total impervious areas and is likely to link with other BMP's in this Section, including reduced imperviousness, reduced setbacks, reduced areas for drives and walkways, etc. All of this directly translates into reduced volumes of stormwater being generated and reduced peak rates of stormwater being generated, thereby benefiting stormwater planning. Additionally, concentrating growth translates into reduced disturbance and increased preservation of the natural landscape and natural vegetative land cover, which further translates into reduced stormwater runoff. To the extent that this BMP also involves increased vertical development, net site roof area and impervious area is reduced, holding number of units and amount of square footage of a use constant. In all cases, density bonuses, if utilized in Receiving Zones, should be scrutinized to make sure that additional density allowed is more than balanced by additional open space being provided, including further reductions in street lengths, other impervious surfaces, other disturbed areas, and so forth. If properly implemented, these smart growth techniques such as TDR and Growth Boundaries will almost always translate into reduced total disturbed area and reduced total impervious area, even more dramatically than non-structural techniques such as clustering.

Documentation of the positive water quality effects of area wide growth concentration, holding total growth and development constant, is provided by the City of Olympia's (Washington) *Impervious Surface Reduction Study: Final Report 1995*. Holding population projected to 2015 constant, two dramatically different scenarios of land development (a baseline pattern of low density unconcentrated development reflecting recent development trends versus a concentrated pattern of increased density development in and near existing developed areas) were defined. These were mapped (Figure 5.5-7) and tested for a variety of stormwater-related impacts (total impervious area, total disturbed area, stormwater generation, non-point source pollutant generation). The analysis results indicated that the concentrated development scenario significantly reduced total impervious area. This was due to significant reductions in impervious surfaces being created in outlying rural and low density areas and more efficient utilization of impervious surfaces already created in areas of existing development. Other studies focusing on concentrated growth patterns have similarly confirmed these relationships and further documented a reduction in total disturbed areas created, stormwater being generated, and total non-point source pollutant loads being generated.

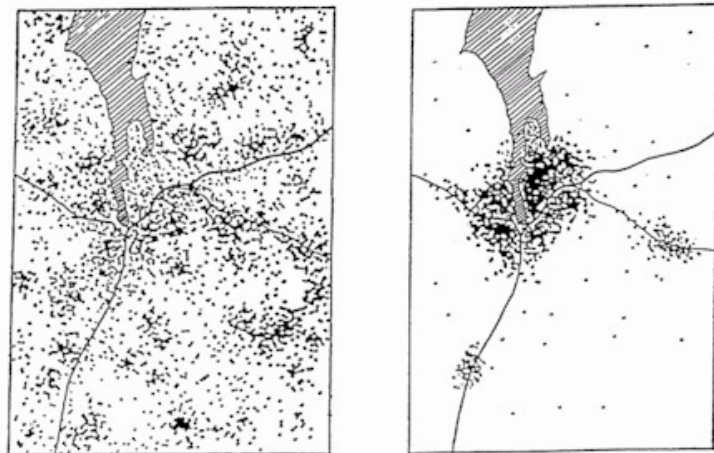


Figure 5.5-7 Dispersed versus Concentrated Development at the Regional Scale, (Source: "Impervious Surface Reduction Study", City of Olympia, 1995)

As stated above in BMP 5.5.1, water quality issues include all the non-point source pollutant load from impervious areas, as well as all the pollutant load from the newly created maintained landscape (i.e., lawns and other), much of which is soluble in form (especially fertilizer-linked nitrogen forms). Concentrating growth as defined in BMP 5.5.2, and combined with other Chapter 5 Non-Structural BMP's, minimizes impervious areas and the pollutant loads related to these impervious areas. After Chapter 5 BMP's are optimized, "unavoidable" stormwater is then directed into BMP's as set forth in Chapter 6, to be

properly treated. Similarly, for all that non-point source pollutant load generated from the newly-created maintained landscape and combined with other Chapter 5 Non-Structural BMP's, minimizes pervious areas and the pollutant loads related to these pervious areas, thereby reducing the opportunity for fertilization and other chemical application. Prevention of water quality degradation accomplished through Non-Structural BMP's in Chapter 5 is especially important because Chapter 6 Structural BMP's remain poor performers in terms of mitigating/removing soluble pollutants that are especially problematic in terms of this pervious maintained landscape. See Appendix A for additional documentation of the water quality benefits of clustering.

See Chapter 8 for additional volume reduction calculation work sheets, additional peak rate reduction calculation work sheets, and additional water quality mitigation work sheets.

## **Construction Sequence**

Application of this BMP must be undertaken by the municipality and must precede the start of any individual site planning and development process. In most cases, the municipality must take action in its comprehensive plan and then in its zoning and SLDO to incorporate the optimal blend of these smart growth techniques in their respective municipal planning and growth management program (the proactive municipality may act further to program for use of conservation easements, creation of a local land trust, and the like). At the same time, the site owner/builder/developer may elect to embrace options set forth in BMP 5.5.2 Concentrate Uses Area wide from the start of the process. Use of conservation easement donation, bargain sale or limited development all require careful consideration by the site owner/builder/developer from the beginning of the site development process.

## **Maintenance Issues**

Very few maintenance problems or issues are generated by BMP 5.5.2. Because most of these smart growth techniques are preventive in nature and in fact translate into maximum retention of undisturbed open space and the natural features contained within this open space, typically in private ownership, specific maintenance requirements as defined in a conventional manner are extremely limited, if not nonexistent.

## **Cost Issues**

According to Delaware's recent *Conservation Design for Stormwater Management: A Design Approach to Reduce Stormwater Impacts from Land Development*, application of the municipality-wide or areawide smart growth techniques will require some additional costs. Application of an optional TDR program or Growth Boundary program could cost a municipality in technical planning fees, including incorporation into the comprehensive plan and zoning ordinance (other costs may be required as well). Although it is hard to specifically document, a program of structural BMP's which mitigate adverse impacts of land development and achieve the same level of water resource (quantity and quality) performance throughout the municipality and its respective watershed areas becomes much more difficult to achieve, and much more expensive when all development and all lots are tallied. Prevention is simply much more cost effective.

Furthermore, BMP 5.5.2's preventive smart growth techniques, when fully applied, achieve a level of performance that exceed even the best structural BMP's. This clearly demonstrates why non-structural BMP's are important for all Pennsylvania watersheds, but especially important for Special Protection Waters where High Quality and Exceptional Value designations call for extremely high levels of water resource protection. In these cases, significant amounts of development watershed-wide, even

assuming use of Chapter 6 structural BMP's, may fail to provide the water resource protection which is needed to sustain special Protection Waters' values over the long-term.

### **Specifications**

BMP 5.5.2 is not a new concept and has been defined, discussed, and evaluated in many different texts, reports, references, sources, as set forth below. More specifications for clustering can be found in references that are included in above discussions.

## **5.6 Minimize Disturbance and Minimize Maintenance**





## BMP 5.6.1: Minimize Total Disturbed Area - Grading



Without changing the building program, you can reduce site grading, removal of existing vegetation (clearing and grubbing) and total soil disturbance. This eliminates the need for re-establishment of a new maintained landscape for the site and lot-by-lot, by modifying the proposed road system and other relevant infrastructure as well as the building location and elevations to better fit the existing topography.

<p style="text-align: center;"><b><u>Key Design Elements</u></b></p> <ul style="list-style-type: none"> <li>▪ Identify and avoid special value and environmentally sensitive areas</li> <li>▪ Minimize overall disturbance at the site</li> <li>▪ Minimize disturbance at the individual lot level</li> <li>▪ Maximize soil restoration to restore permabilities</li> <li>▪ Minimize construction-traffic locations</li> <li>▪ Minimize stockpiling and storage areas</li> </ul>	<p style="text-align: center;"><b><u>Potential Applications</u></b></p> <p style="text-align: center;">Residential: Yes  Commercial: Yes  Ultra Urban: Limited  Industrial: Yes  Retrofit: Limited  Highway/Road: Limited</p> <hr/> <p style="text-align: center;"><b><u>Stormwater Functions</u></b></p> <p style="text-align: center;">Volume Reduction: High  Recharge: High  Peak Rate Control: High  Water Quality: High</p> <hr/> <p style="text-align: center;"><b><u>Water Quality Functions</u></b></p> <p style="text-align: center;">TSS: 40%  TP: 0%  NO3: 0%</p>
--	---

## Description

This Non-Structural BMP assumes that the special value and sensitive resource areas have been identified on a given development parcel and have been protected, and that clustering and area wide concentration of uses also have been considered and included in the site design. All of these BMPs serve to reduce site grading and to minimize disturbance/minimize maintenance. This BMP specifically focuses on how to minimize the grading and overall site disturbance required to build the desired program while maximizing conservation of existing site vegetation.

Reduction of site disturbance by grading can be accomplished in several ways. The requirements of grading for roadway alignment (curvature) and roadway slope (grade) frequently increase site disturbance throughout a land development site and on individual lots. Most land development plans are formulated in 2-dimensional plan, based on the potential zoned density, and seldom consider the constraints presented by topographic variation (slope) on the site. The layout and design of internal roadways on a land development site with significant topographic variation (slope) can result in extensive earthwork and vegetation removal (i.e., grading). Far less grading and a far less disruptive site design can be accomplished if the site design is made to better conform with the existing topography and land surface, where road alignments strive to follow existing contours as much as possible, varying the grade and alignment criteria as necessary to comply with safety limits.

Site design criteria have evolved in municipalities to make sure that developments meet safety standards (sight distance, winter icing, and so forth) as well as certain quality or appearance standards. A common perception among municipal officials is that little deviation should be allowed in order to maintain the integrity of the community. In fact, roadway design criteria should be made flexible in order to better fit a given parcel and achieve a more “fluid” roadway alignment. The avoidance of sensitive site features, such as important woodlands, may be facilitated through flexible roadway layout. Additionally, rigorous parcel criteria (front footage, property setbacks, etc.) often add to this “plane geometry” burden. Although the rectilinear grid layout is the most efficient in terms of maximizing the number of potential lots created at a development site, the end result is a “cookie cutter” pattern normally found in residential sites and the “strip” development found in most highway commercial districts, all of which are apt to translate into significant resource loss.



Figure 5.6-1 Residential Area with Disturbance Minimized

From the perspective of a single lot, the municipally-required conventional lot layout geometry can also impose added earthwork and grading that could be avoided. Lot frontage criteria, yard criteria, and driveway criteria force the placement of a structure in the center of every lot, often pushed well back from the roadway. Substantial terracing of the lot with added grading and vegetation removal is required in many cases. Although the intent of these municipal requirements is to provide privacy and spacing between units, the end result is often totally cleared, totally graded lots, which can be visually monotonous. Configuring lots in a rectilinear shape may optimize the number of units but municipalities should require that the site design in total should be made to fit the land as much as possible.

Municipal criteria that impose road geometry are usually contained within the subdivision and land development ordinance (SALDO), while densities, lot and yard setbacks, and minimum frontages are usually contained in the zoning ordinance. Variations in these land development standards should be

accepted by the local government where appropriate, which should modify their respective ordinances. Municipalities should consider being more flexible without compromising public safety in terms of:

- Road vertical alignment criteria (maximum grade or slope).
- Road horizontal alignment criteria (maximum curvature)
- Road frontage criteria (lot dimensions)
- Building setback criteria (yards dimensions)

Related Non-Structural BMPs, such as road width dimensions, parking ratios, impervious surface reduction, chemical maintenance of newly created landscapes, and others are discussed as separate BMPs in this Chapter, though are all substantially interrelated.

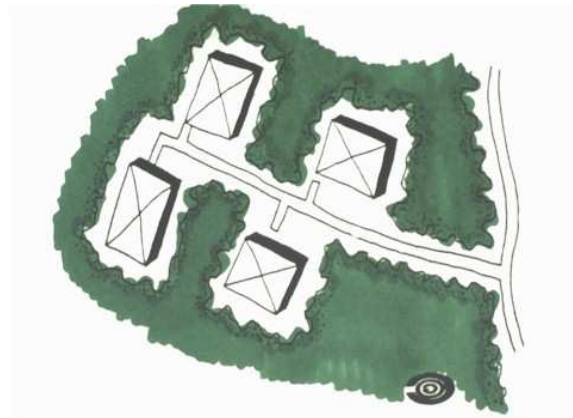


Figure 5.6-2 Minimally Disturbed Development

## Detailed Stormwater Functions

**Volume Reduction Calculations:** Minimizing Total Disturbed Area can reduce the volume of runoff in several ways. Reducing disturbance and maintaining a natural cover can significantly reduce the anticipated volume of runoff through increased infiltration and increased evapotranspiration. This practice will be self-crediting in site stormwater calculations through lower runoff coefficients and/or higher infiltration rates. Minimizing Total Disturbed Area can reduce anticipated runoff volumes because undisturbed areas of existing vegetation allow more infiltration to occur, especially during smaller storm events. Furthermore, employing strategies that direct non-erosive sheet flow onto naturally vegetated areas can allow considerable infiltration to occur and can be coupled with level spreading devices (see Chapter 6) and possibly other BMPs to more actively manage stormwater that cannot be avoided. In other words, Minimizing Total Disturbed Area/Maintained Area through Reduced Site Grading (Designing with the Land) not only prevents increased stormwater generation (a volume and peak issue), but also offers an opportunity for managing stormwater generation that cannot be avoided. See Chapter 8 for volume reduction calculation methodologies.

**Peak Rate Mitigation Calculations:** Minimizing Total Disturbed Area/Maintained Area through Reduced Site Grading (Designing with the Land) can reduce the peak rate of runoff in several ways. Reducing disturbance and maintaining a natural cover can significantly reduce the runoff rate. This will be self-crediting in site stormwater calculations through lower runoff coefficients, higher infiltration rates, and longer times of travel. Minimizing Total Disturbed Area/Maintained Area through Reduced Site Grading (Designing with the Land) can lower discharge rates significantly by slowing runoff and increasing on-site storage.

**Water Quality Improvement:** Minimizing Total Disturbed Area can improve water quality preventively by reducing construction phase sediment-laden runoff. Water quality benefits also by maximizing preservation of existing vegetation at a site (e.g., meadow, woodlands) where post-construction maintenance including application of fertilizers and pesticides/herbicides is avoided. Given the high rates of chemical application which have been documented at newly created maintained areas for both residential and non-residential land uses, eliminating the opportunity for chemical application is important for water quality – perhaps the most effective management technique. In terms of water quality mitigative functions, Minimizing Total Disturbed Area provides filtration and infiltration opportunities, assuming that undisturbed areas are being used to manage

stormwater generated elsewhere on the development site, as well as thermal mitigation. See Chapter 8 for Water Quality Improvement methodologies.

## Design Considerations

During the initial conceptual design phase of a land development project, the applicant's design engineer should provide the following information, ideally through development of a Minimum Disturbance/Minimum Maintenance Plan:

### 1. Identify and Avoid Special Value/Sensitive Areas (see BMP 5.4.1)



Figure 5.6-3 Woodlands Protected through Minimum Disturbance Practices

Delineate and avoid environmentally sensitive areas (e.g., Primary and Secondary Conservation areas, as defined in BMP 5.4.1); delineation of Woodlands, broadly defined to include areas of immature and mixed tree growth, is especially important; configure the development program on the balance of the parcel (i.e., Development Areas as discussed in BMP 5.4.1).

### 2. Minimize Disturbance at Site

Modify road alignments (grades, curvatures, etc.), lots, and building locations to minimize grading, earthwork, overall site disturbance, as necessary to maintain safety standards. Minimal disturbance design shall allow the layout to best fit the land form without significant earthwork. The limit of grading and disturbance should be designated on the plan documentation submitted to the municipality for review/approval, and should be physically designated at the site during construction by flagging, fencing, or other methods.

### 3. Minimize Disturbance at Lot

Limit lot grading to roadways and building footprints. Municipalities should establish Minimum Disturbance/Minimum Maintenance Buffers, designed to be rigorous but reasonable in terms of current feasible site construction practices. These standards may need to vary with the type of development being proposed and the context of that development (the required disturbance zone around a low density single-family home can be expected to be less than disturbance necessary for a large commercial structure), given the necessity for use of different types of construction equipment and the realities of different site conditions. For example, the U.S. Green Building Council's Leadership in Energy & Environmental Design Reference Guide (Version 2.0 June 2001) specifies the following:

“...limit site disturbance including earthwork and clearing of vegetation to **40 feet** beyond the building perimeter, **5 feet** beyond the primary roadway curbs, walkways, and main utility branch trenches, and **25 feet** beyond pervious paving areas that require additional staging areas in order to limit compaction in the paved area...”

Municipalities in New Jersey’s Pinelands Preservation Zone for years have supported ordinances where limits are more restrictive than the LEED footages (e.g., clearing around single-family homes is reduced to 25 feet). Again, such requirements can be made to be flexible with special site factors and conditions. The limit of grading and disturbance should be designated on the plan documentation submitted to the municipality for review/approval, and should be physically designated at the lot during construction by flagging, fencing or other marking techniques.

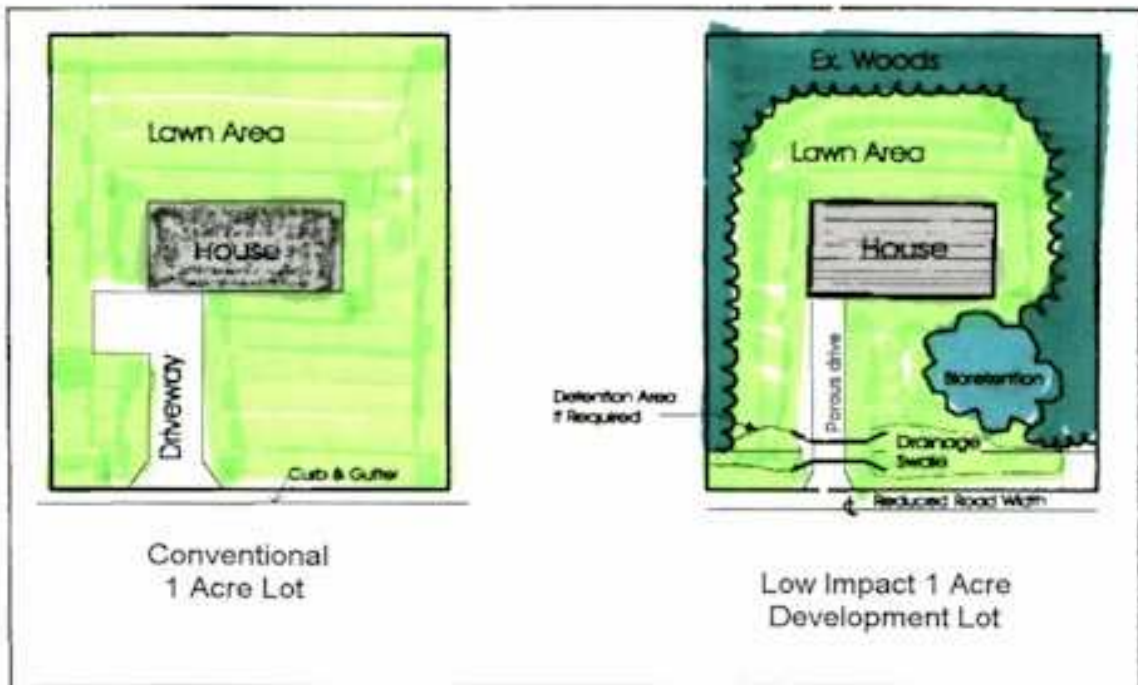


Figure 5.6-4 Conventional Development Versus Low Impact Development

#### 4. Maximize Soil Restoration

Where construction activity does require grading and filling and where compaction of soil can be expected, this disturbance should be limited. Soil treatments/amendments should be considered for such disturbed areas to restore permeability. If the bulk density is not reduced following fill, these areas will be considered semi-impervious after development and runoff volumes calculated accordingly.

#### 5. Minimize Construction Traffic Areas

Areas where temporary construction traffic is allowed should be clearly delineated and limited. These areas should be restored as pervious areas following development through a required soil restoration program.

## 6. Minimize Stockpiling and Storage Areas

All areas used for materials storage during construction should be clearly delineated with the surface maintained, and subject to a soil restoration program following development. For low-density developments, the common practice of topsoil stripping might be unnecessary and should be minimized, if not avoided.

## Construction Issues

Most of the measures discussed above are part of the initial concept site plan and site design process. Only those measures that restore disturbed site soils are related to the construction and post-construction phase, and may be considered as avoidance of impacts.

## Cost Issues

Cost avoidance as a result of reduced grading and earthwork should benefit the developer. This BMP is considered to be self-crediting, given the benefits resulting from reduced costs. Cost issues include reduced grading and related earthwork (see Site Clearing and Strip Topsoil and Stockpile below), as well as reduced costs involved with site preparation, fine grading, and stabilization.

Calculation of reduced costs is difficult due to the extreme variation in site factors that will affect costs (amount of grading, cutting/filling, haul distances for required trucking, and so forth). Some relevant costs factors are as follows (as based on R.S. Means, *Site Work & Landscape Cost Data*, 2002):

### Site Clearing

Cut & chip light trees to 6" diameter	\$2,900/acre
Grub stumps and remove	\$1,400/acre

Cut & chip light trees to 24" diameter	\$9,700/acre
Grub stumps and remove	\$5,600/acre

### Strip Topsoil and Stockpile

Ranges from \$0.52 to \$1.78 / cy because of Dozer horse power, and ranges from ideal to adverse conditions

Assuming 8" of topsoil, the price per sq. yd. is \$0.12 – \$0.40

Assuming 8" of topsoil, the price per acre is \$560 – \$1,936

### Site Preparation, Fine Grading, Seeding

Fine grading w/ seeding \$2.33 /sq. yd.

Fine grading w/ seeding \$11,277 /acre

In sum, total costs appear to approximate \$20,000 per acre and could certainly exceed that figure in more challenging sites. Reducing graded and disturbed acreage clearly translates into substantial cost reductions.

## Stormwater Management Calculations

No calculations are applicable for this BMP.

## **Specifications**

The modification of road geometry is a site-specific issue, but in general any criteria that will result in significant earthwork should be reconsidered and evaluated.





## BMP 5.6.2: Minimize Soil Compaction in Disturbed Areas



Minimizing Soil Compaction and Ensuring Topsoil Quality is the practice of enhancing, protecting, and minimizing damage to soil quality caused by land development.

*Image Source: "Developing an Effective Soil Management Strategy: Healthy Soil Is At the Root Of Everything", Ocean County Soil Conservation District*

<p style="text-align: center;"><b><u>Key Design Elements</u></b></p> <ul style="list-style-type: none"> <li>▪ Protecting disturbed soils areas from excessive compaction during construction</li> <li>▪ Minimizing large cleared areas and stockpiling of topsoil</li> <li>▪ Using quality topsoil</li> <li>▪ Maintaining soil quality after construction</li> <li>▪ Reducing the Site Disturbance Area through design and construction practices</li> <li>▪ Soil Restoration for areas that are not adequately protected or have been degraded by previous activities (Section 6)</li> </ul>	<p style="text-align: center;"><b><u>Potential Applications</u></b></p> <p style="text-align: center;">Residential: Yes Commercial: Yes Ultra Urban: Yes Industrial: Yes Retrofit: Yes Highway/Road: Yes</p> <hr/> <p style="text-align: center;"><b><u>Stormwater Functions</u></b></p> <p style="text-align: center;">Volume Reduction: Very High Recharge: Very High Peak Rate Control: High Water Quality: Very High</p> <hr/> <p style="text-align: center;"><b><u>Water Quality Functions</u></b></p> <p style="text-align: center;">TSS: 30% TP: 0% NO3: 0%</p>
---	--

## Description:

Soil is a physical matrix of weathered rock particles and organic matter that supports a complex biological community. This matrix has developed over a long time period and varies greatly within the state. Healthy soils, which have not been compacted, perform numerous valuable stormwater functions, including:

- Effectively cycling nutrients
- Minimizing runoff and erosion
- Maximizing water-holding capacity
- Reducing storm runoff surges
- Adsorbing and filtering excess nutrients, sediments, pollutants to protect surface and groundwater
- Providing a healthy root environment and creating habitat for microbes, plants, and animals
- Reducing the resources needed to care for turf and landscape plantings

Once natural soils are overly compacted and permeability is drastically reduced, these functions are lost and can never be completely restored (Hanks and Lewandowski, 2003). In fact, the runoff response of vegetated areas with highly compacted soils closely resembles that of impervious areas, especially during large storm events (Schueler, undated). Therefore this BMP is intended to prevent compaction or minimize the degree and extent of compaction in areas that are to be “pervious” following development.

Although erosion and sediment control practices are equally important to protect soil, this BMP differs from them in that it is intended to reduce the area of soil that experiences excessive compaction during construction activities.

## Applications

This BMP can be applied to any land development that has existing areas of relatively healthy soil and proposed “pervious” areas. If existing soils have already been excessively compacted, Soil Restoration is applicable (Chapter 6).



*Figure 5.7-1 Example of development with site compaction of soils*

## Design Considerations

Early in the design phase of a project, the designer should develop a soil management plan based on soil types and existing level of disturbance (if any), how runoff will flow off existing and proposed impervious areas, areas of trees and natural vegetation that can be preserved, and tests indicating soil depth and quality. The plan should clearly show the following:

- 1. Protected Areas.** Soil and vegetation disturbance is not allowed. Protection of healthy, natural soils is the most effective strategy for preserving soil functions. Not only can the functions be maintained but protected soil organisms are also available to colonize neighboring disturbed areas after construction.
- 2. Minimal Disturbance Areas.** Limited construction disturbance occurs - soil amendments may be necessary for such areas to be considered fully pervious after development. Areas to be vegetated after development should be designated Minimal Disturbance Areas.
- 3. Construction Traffic Areas.** Areas where construction traffic is allowed - if these areas are to be considered fully pervious following development, a program of Soil Restoration will be required.
- 4. Topsoil Stockpiling and Storage Areas.** These areas should be protected and maintained and are subject to Soil Restoration (including compost and other amendments) following development.
- 5. Topsoil Quality and Placement.** Soil tests are recommended. Topsoil applied to disturbed areas should meet certain parameters as shown in Appendix C. Adequate depth (4" minimum for turf, more for other vegetation), organic content (5% minimum), and reduced compaction (1400 kPa maximum) are especially important (Hanks and Lewandowski, 2001). To allow water to pass from one layer to the other, topsoil must be "bonded" to the subsoil when it is reapplied to disturbed areas.



*Figure 5.7-2 Example of site development with extreme soil compaction on steep slope*

The first two areas (Protected and Minimal Disturbance) should be made as large as possible, identified by signage, and fenced off from construction traffic. Construction Traffic Areas should be as small as practicable.

## **Detailed Stormwater Functions**

### **Volume Reduction Calculations**

Minimizing Soil Compaction and Ensuring Topsoil Quality can reduce the volume of runoff by maintaining soil functions related to stormwater and thereby increasing infiltration and evapotranspiration. This can be credited in site stormwater calculations through lower runoff coefficients and/or higher infiltration rates. See Chapter 8 for volume reduction calculation methodologies.

### **Peak Rate Mitigation Calculations**

Minimizing Soil Compaction and Ensuring Topsoil Quality can reduce the rate of runoff by maintaining soil functions related to stormwater. This can be credited in site stormwater calculations through lower runoff coefficients, higher infiltration rates, and/or longer times of travel. See Chapter 8 for peak rate calculation methodologies.

### **Water Quality Improvement**

Minimizing Soil Compaction and Ensuring Topsoil Quality can improve water quality through infiltration, filtration, chemical and biological processes in the soil, and a reduced need for fertilizers and pesticides after development. See Chapter 8 for Water Quality Improvement methodologies.

## **Construction Issues**

1. At the start of construction, Protected and Minimal Disturbance Areas must be identified with signage and fenced as shown on the construction drawings.
2. Protected and Minimal Disturbance Areas should be strictly enforced.
3. Protected and Minimal Disturbance Areas should be protected from excessive sediment and stormwater loads while upgradient areas remain in a disturbed state.
4. Topsoil storage areas should be maintained and protected at all times. When topsoil is reapplied to disturbed areas it must be "bonded" with the subsoil. This can be done by spreading a thin layer of topsoil (2 to 3 inches), tilling it into the subsoil, and then applying the remaining topsoil. Topsoil must meet certain requirements as detailed in Appendix C.

## **Maintenance Issues**

Sites that have minimized soil compaction properly during the development process should require considerably less maintenance than sites that have not. Landscape vegetation will likely be healthier, have a higher survival rate, require less irrigation and fertilizer, and even look better.

Some maintenance activities such as frequent lawn mowing can cause considerable soil compaction after construction and should be avoided whenever possible. Planting low-maintenance native vegetation is the best way to avoid damage due to maintenance.

Protected Areas on private property could have an easement, deed restriction, or other legal measure to prevent future disturbance or neglect.

## **Cost Issues**

Minimizing Soil Compaction and Ensuring Topsoil Quality generally results in a significant construction cost savings. Minimizing soil compaction can reduce disturbance, clearing, earthwork, the need for Soil Restoration, and the size and extent of costly, engineered stormwater management systems. Ensuring topsoil quality can significantly reduce the cost of landscaping vegetation (higher survival rate, less replanting) and landscaping maintenance.

Design costs may increase slightly due to a more thoughtful, site-specific design.

## **Specifications**

Soil Restoration specifications can be found in Chapter 6.

## **References**

Hanks, D. and Lewandowski, A. *Protecting Urban Soil Quality: Examples for Landscape Codes and Specifications*. USDA-NRCS, 2003.

Ocean County Soil Conservation District. *Impact of Soil Disturbance during Construction on Bulk Density and Infiltration in Ocean County, New Jersey*. 2001. Available at <http://www.ocscd.org/publications.shtml> as of May 2004.

Schueler, T. "The Compaction of Urban Soils," Technical Note #107 from *Watershed Protection Techniques*. 3(2): 661-665, undated.



## BMP 5.6.3: Re-Vegetate and Re-Forest Disturbed Areas, Using Native Species



Sites that require landscaping and re-vegetation should select and use vegetation (i.e., native species) that does not require significant chemical maintenance by fertilizers, herbicides, and pesticides.

Image: Rose Mallow, Bowman's Hill Wildflower Preserve, [www.bhwp.org](http://www.bhwp.org)

<p style="text-align: center;"><b><u>Key Design Elements</u></b></p> <ul style="list-style-type: none"> <li>▪ Preserve all existing high quality plant materials and soil mantle wherever possible</li> <li>▪ Protect these areas during construction</li> <li>▪ Develop Landscape Plan using native species</li> <li>▪ Reduce landscape maintenance, especially grass mowing</li> <li>▪ Reduce or eliminate chemical applications to the site, wherever possible</li> <li>▪ Reduce or eliminate fertilizer and chemical-based pest control programs, wherever possible</li> </ul>	<p style="text-align: center;"><b><u>Potential Applications</u></b></p> <p>Residential: Yes  Commercial: Yes  Ultra Urban: Limited  Industrial: Yes  Retrofit: Yes  Highway/Road: Limited</p>
	<p style="text-align: center;"><b><u>Stormwater Functions</u></b></p> <p>Volume Reduction: Low/Med.  Recharge: Low/Med  Peak Rate Control: Low/Med.  Water Quality: Very High</p>
	<p style="text-align: center;"><b><u>Water Quality Functions</u></b></p> <p>TSS: 85%  TP: 85%  NO3: 50%</p>

## Description of BMP

Minimum Disturbance/Minimum Maintenance is comprised of two distinct steps, neither of which involves structural BMPs. The first step is to preserve existing vegetation on the development site as defined in BMP 5.6.1, so as to minimize the need for landscaping and re-vegetation. This BMP emphasizes the second step - the selection and use of vegetation that does not require significant chemical maintenance by fertilizers, herbicides and pesticides. Implicit in this BMP is the assumption that native species have the greatest tolerance and resistance to pests and require less fertilization and chemical application than non-native species. Landscape architects specializing in the local plant community usually are able to identify a variety of species that meet these criteria.

The production of biomass, such as grass clippings, is a significant pollutant source for water quality (if this biomass is not removed, over time this biomass decays and is converted to additional nutrient sources which add to the water quality problem). Native grasses and other herbaceous materials that do not require mowing are preferred. Because the selection of such materials begins at the concept design stage, where lawns are avoided or eliminated and landscaping species selected, this Non-Structural BMP can generally result in a site with reduced runoff volume and rate, as well as significant nonpoint source load reduction/prevention.

A native landscape may take several forms in Pennsylvania, ranging from re-establishment of woodlands to re-establishment of meadow. It should be noted that as this native landscape grows and matures, the positive stormwater benefits relating to volume control and peak rate control increase and these landscapes become much more effective in reducing runoff volumes than maintained landscapes such as lawns.

The elimination of traditional lawns as a site design element can be an extremely difficult BMP to implement, given the extent to which the traditional lawn as an essential landscape design feature is embedded in current national culture.

Additional information relating to native species and their use in landscaping is available through PADCNr and its website: <http://www.dcnr.state.pa.us/forestry/wildplant/native.aspx>

## Detailed Stormwater Functions

**Volume Reduction Calculations** and **Peak Rate Calculations** are not affected substantially by this BMP - at least in the short term. In the longer term, as species grow and mature, the runoff volume production of more mature native species can reasonably be expected to be lower than a conventionally maintained landscape (especially the conventionally mowed lawn). Native species are customarily strong growers with stronger and denser root and stem systems, thereby generating less runoff. If the objective is re-vegetation with woodland species, the longer-term effect is a significant reduction in runoff volumes, with increases in infiltration, evapotranspiration, and recharge, when contrasted with a conventional lawn planting. Peak rate reduction also is achieved. Similarly, meadow re-establishment is also more beneficial than a conventional lawn planting, although not so much as the woodland landscape. Again, these benefits are long term in nature and will not be forthcoming until the species have had an opportunity to grow and mature (one advantage of the meadow is that this maturation process requires considerably less time than a woodland area).

### Water Quality Improvement

Minimizing Disturbance/Minimizing Maintenance through Use Native Species for Landscaping and Re-Vegetation can improve water quality preventively by minimizing application of fertilizers and pesticides/herbicides. Given the high rates of chemical application which have been documented at



newly created maintained areas for both residential and non-residential land uses, eliminating the opportunity for chemical application is important for water quality – perhaps the most effective management technique. Of special importance here is the reduction in fertilization and nitrate loadings. For example, Delaware's *Conservation Design for Stormwater Management* lists multiple studies, which document high fertilizer application rates, including both nitrogen and phosphorus, in newly created landscapes in residential and non-residential land developments. Expansive lawn areas in low density single-family residential subdivisions as well as large office parks – development which has and continues to proliferate in Pennsylvania municipalities - typically receives intensive chemical application, both fertilization and pest control, which can exceed application rates being applied to agricultural fields. Avoidance of this nonpoint pollutant source is an important water quality objective. See Chapter 8 for Water Quality Improvement methodologies.

## **Design Considerations**

Native species is a broad term. Different types of native species landscapes may be created, from meadow to woodland areas, obviously requiring different approaches to planting. In terms of woodland areas, Delaware's *Conservation Design for Stormwater Management* states, "...a mixture of young trees and shrubs is recommended.... Tree seedlings from 12 to 18 inches in height can be used, with shrubs at 18 to 24 inches. Once a ground cover crop is established (to offset the need for mowing), trees and shrubs should be planted on 8-foot centers, with a total of approximately 430 trees per acre. Trees should be planted with tree shelters to avoid browse damage in areas with high deer populations, and to encourage more rapid growth." (p.3-50). As tree species grow larger, both shrubs and ground covers recede and yield to the more dominant tree species. The native tree species mix of small inexpensive saplings should be picked for variety and should reflect the local forest communities. Annual mowing to control invasives may be necessary, although the quick establishment of a strong-growing ground cover can be effective in providing invasive control. Native meadow planting mixes also are available. A variety of site design factors may influence the type of vegetative community, which is to be planned and implemented. In so many cases, the "natural" vegetation of Pennsylvania's communities is, of course, woodland.

Native species plantings can achieve variation in landscape across a variety of characteristics, such as texture, color, and habitat potential. Properly selected mixes of flowering meadow species can provide seasonal color; native grasses offer seasonal variation in texture. Seed production provides a food source and reinforces habitat. In all cases, selection of native species should strive to achieve species variety and balance, avoiding creation of single-species or limited species "monocultures" which pose multiple problems. In sum, many different aspects of native species planting reinforce the value of native landscaping, typically increasing in their functional value as species grow and mature over time.

## **Maintenance Issues**

Although many conventional landscape management requirements are made unnecessary with this BMP, Using Native Species for Landscaping and Re-Vegetation can be expected to require some level of management – especially in the short term immediately following installation. Woodland areas planted with a proper cover crop can be expected to require annual mowing in order to control invasives. Application of a carefully selected herbicide around the protective tree shelters/tubes may be necessary, reinforced by selective cutting/manual removal, if necessary. This initial maintenance routine is necessary for the first 2 to 3 years of growth and may be necessary for up to 5 years until tree growth and tree canopy begins to form, naturally inhibiting weed growth. Once shading is adequate, growth of invasives and other weeds will be naturally prevented, and the woodland becomes self-maintaining. Review of the new woodland should be undertaken intermittently to determine if replacement trees should be provided (some modest rate of planting failure is typical). Meadow

management is somewhat more straightforward; a seasonal mowing may be required, although care must be taken to make sure that any management is coordinated with essential reseeding and other important aspects of meadow re-establishment.

## Construction Issues

During the initial conceptual design phase of a project, the design engineer should develop a Minimum Disturbance/Minimum Maintenance concept plan that includes the following:

- Areas of Existing Vegetation Being Preserved
- Areas to Be Re-Vegetated/Landscaped by Type (i.e., Native Species Woodland, Meadow, etc. plus Non-Native Conventional Areas)
- A landscape maintenance plan that avoids/minimizes mowing and other maintenance, except for limited areas of high visibility, special needs, etc.; specific landscape areas not to receive fertilization and other chemical applications should be identified in plan documentation

This information needs to appear on the plan drawings and receive municipal review and approval. Existing Vegetation Being Preserved must be flagged or fenced in the field. In terms of specific construction sequencing, all plantings including native species should be installed during the final construction phase of the project. Because native species plantings are likely to have a less “finished” appearance than conventionally landscaped areas, additional field identification for these areas through flagging or fencing similar to Existing Vegetation Being Preserved should be considered.

## Cost Issues

BMP 5.6.3 cost implications are minimal during construction. Seeding for installation of a conventional lawn is likely to be less expensive than planting of a “cover” of native species, although when contrasted with a non-lawn landscape, “natives” often are not more costly than other non-native landscape species. In terms of woodland creation, somewhat dated (1997) costs have been provided by the *Chesapeake Bay Riparian Handbook: A Guide for Establishing and Maintaining Riparian Forest Buffers*:

\$860/acre trees with installation  
\$1,600/acre tree shelters/tubes and stakes  
\$300/acre for four waterings on average

Current values may be considerably higher, well over \$3,000/acre for installation costs. Costs for meadow re-establishment are lower than those for woodland, in part due to the elimination of the need for shelters/tubes. Again, such costs can be expected to be greater than installation of conventional lawn (seeding and mulching), although the installation cost differences diminish when conventional lawn seeding is redefined in terms of conventional planting beds.

Cost differentials grow greater when longer term operating and maintenance costs are taken into consideration. If lawn mowing can be eliminated, or even reduced significantly to a once per year requirement, substantial maintenance cost savings result, often in excess of \$1,500 per acre per year. If chemical application (fertilization, pesticides, etc.) can be eliminated, substantial additional savings result with use of native species. These reductions in annual maintenance costs resulting from a native landscape re-establishment very quickly outweigh any increased installation costs that are required at project initiation. Unfortunately, because developers pay for the installation costs and longer term

reduced maintenance costs are enjoyed by future owners, there is reluctance to embrace native landscaping concepts.

## **Stormwater Management Calculations**

See Chapter 8 for calculations.

## **References**

Bowman's Hill Wildflower Preserve, Washington Crossing Historic Park, PO Box 685, New Hope, PA 18938-0685, Tel (215) 862-2924, Fax (215) 862-1846, Native plant reserve, plant sales, native seed, educational programs, [www.bhwp.org](http://www.bhwp.org)

Morris Arboretum of the University of Pennsylvania; 9414 Meadowbrook Avenue, Philadelphia, PA 19118, Tel (215) 247-5777, [www.upenn.edu/morris](http://www.upenn.edu/morris), PA Flora Project Website: Arboretum and gardens (some natives), educational programs, PA Flora Project, [www.upenn.edu/paflora](http://www.upenn.edu/paflora)

Pennsylvania Department of Conservation and Natural Resources; Bureau of Forestry; PO Box 8552, Harrisburg, PA 17105-8552, Tel (717)787-3444, Fax (717)783-5109, Invasive plant brochure; list of native plant and seed suppliers in PA; list of rare, endangered, threatened species.

Pennsylvania Native Plant Society, 1001 East College Avenue, State College, PA 16801  
[www.pawildflower.org](http://www.pawildflower.org)

Western Pennsylvania Conservancy; 209 Fourth Avenue, Pittsburgh, PA 15222, Tel (412) 288-2777, Fax (412) 281-1792, [www.paconserve.org](http://www.paconserve.org)



## **5.7 Reduce Impervious Cover**



## BMP 5.7.1: Reduce Street Imperviousness

---



Reduce impervious street areas by minimizing street widths and lengths.

<p style="text-align: center;"><b><u>Key Design Elements</u></b></p> <ul style="list-style-type: none"> <li>▪ Evaluate traffic volume and on-street parking requirements.</li> <li>▪ Consult with local fire code standards for access requirements.</li> <li>▪ Minimize pavement by using alternative roadway layouts, restricting on-street parking, minimizing cul-de-sac radii, and using permeable pavers.</li> </ul>	<p style="text-align: center;"><b><u>Potential Applications</u></b></p> <p>Residential: Yes  Commercial: Yes  Ultra Urban: Limited  Industrial: Yes  Retrofit: Limited  Highway/Road: Limited</p>
	<p style="text-align: center;"><b><u>Stormwater Functions</u></b></p> <p>Volume Reduction: Very High  Recharge: Very High  Peak Rate Control: Very High  Water Quality: Medium</p>
	<p style="text-align: center;"><b><u>Water Quality Functions</u></b></p> <p>TSS: Preventive  TP: Preventive  NO3: Preventive</p>

## Description

Reducing impervious street areas performs valuable stormwater functions, in contrast to conventional or baseline development. Some of these functions are increasing infiltration, decreasing stormwater runoff volume, increasing stormwater time of concentration, improving water quality by decreasing the pollutant loading of streams, improving natural habitats by decreasing the deleterious effects of stormwater runoff and decreasing the concentration and energy of stormwater. Imperviousness greatly influences stormwater runoff volume and quality by facilitating the rapid transport of stormwater and collecting pollutants from atmospheric deposition, automobile leaks, and additional sources. Increased imperviousness alters an area's hydrology, habitat structure, and water quality. Stream degradation has been witnessed at impervious levels as low as 10-20% (Center for Watershed Protection, 1995).

## Applications

### Street Width

Streets comprise the largest single component of imperviousness in residential design. Universal application of high-volume, high-speed traffic design criteria results in many communities requiring excessively wide streets. Coupled with the perceived need to provide both on-street parking and emergency vehicle access, the end result of these requirements is residential streets that may be 36 feet or greater in width (Center for Watershed Protection, 1998).

The American Society of Civil Engineers (ASCE) and the American Association of State Highway and Transportation Officials (AASHTO) recommend that low traffic volume roads (less than 50 homes or 500 daily trips) can be as narrow as 22 feet. PennDot Pub. 70 gives a range of 18-22 foot width for low volume local roads. Some municipalities have reduced their lowest trafficable residential roads to 18 feet or less. Higher volume roads are recommended to be wider. Table 5.7-1 provides sample road widths from different jurisdictions.

The desire for adequate emergency vehicle access, notably fire trucks, also leads to wider streets. While it is perceived that very wide streets are required for fire trucks, some local fire codes permit roadway widths as narrow as 18 feet (as shown in Table 5.7-2). Concerns also exist about other vehicles and maintenance activities on narrow streets. School buses are typically nine feet wide from mirror to mirror; Prince George's and Montgomery Counties in Maryland require only a 12-foot driving lane for buses (Center for Watershed Protection, 1998). Similarly, trash trucks require only a 10-½ foot driving lane, as they are a standard width of nine feet (Waste Management, 1997; BFI, 1997). In some cases, road width for emergency vehicles may be added through use of permeable pavers for roadway shoulders (see Figure 5.7-1).

Snow removal on narrower streets is readily accomplished with narrow, 8-foot snowplows. Restricting parking to one side of the street allows accumulated snow to be piled on the other side. Safety concerns are also cited as a justification for wider streets, but increased vehicle-pedestrian accidents on narrower streets are not supported by research. The Federal Highway Administration states that narrower streets reduce vehicle travel speeds, decreasing the incidence and severity of accidents.

Higher density developments require wider streets, but alternative layouts can minimize street widths. For example, in instances where on-street parking is desired, impervious pavement is used for the travel lanes and permeable pavers are placed on the road apron for the parking lanes. The width of permeable pavers is often the width of a standard parking lane (six to eight feet). This design approach minimizes impervious area while also providing an infiltration and recharge area for the impervious roadway stormwater (Prince George's County, Maryland, 2002).



**Table 5.7-1: Narrow Residential Street Widths**

Jurisdiction	Residential Street Pavement Width	Maximum Daily Traffic (trips/day)
State of New Jersey	20 ft. (no parking)	0-3,500
	28 ft. (parking on one side)	0-3,500
State of Delaware	12 ft. (alley)	---
	21 ft. (parking on one side)	---
Howard County, Maryland	24 ft. (parking not regulated)	1,000
Charles County, Maryland	24 ft. (parking not regulated)	---
Morgantown, West Virginia	22 ft. (parking on one side)	---
Boulder, Colorado	20 ft.	150
	20 ft. (no parking)	350-1,000
	22 ft. (parking on one side)	350
	26 ft. (parking on both sides)	350
	26 ft. (parking on one side)	500-1,000
Bucks County, Pennsylvania	12 ft (alley)	---
	16-18 ft. (no parking)	200
	20-22 ft. (no parking)	200-1,000
	26 ft. (parking on one side)	200
	28 ft. (parking on one side)	200-1,000

(Cohen, 1997; Bucks County Planning Commission, 1980; Center for Watershed Protection, 1998)

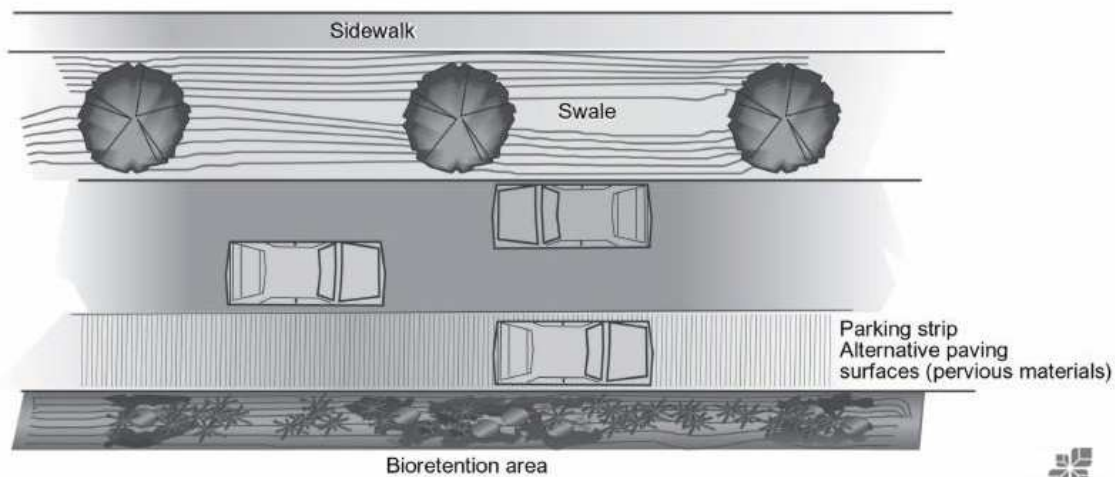


Figure 5.7-1 Reduced road width using adjacent pervious strips.

Courtesy Pierce County, WA 

**Table 5.7-2 Fire Vehicle Street Requirements**

Source	Residential Street Width
U.S. Fire Administration	18-20 ft.
Baltimore County, Maryland Fire Department	16 ft. (no on-street parking) 24 ft. (on-street parking)
Virginia State Fire Marshall	18 ft. minimum
Prince George's County, Maryland Department of Environmental Resources	24 ft. (no parking) 30 ft. (parking on one side) 36 ft. (parking on both sides) 20 ft. (fire truck access)
Portland, Oregon Office of Transportation	18 ft. (parking on one side) 26 ft. (parking on both sides)

(Adapted from Center for Watershed Protection, 1998)

In residential neighborhoods, the perception of the need for large quantities of parking may lead developers to provide on-street parking; residential land use will greatly influence the quantity needed. Each on-street lane increases street impervious cover by 25%. Many communities require 2-2.5 parking spaces per residence. In single-lot neighborhoods, with both standard and reduced setbacks, parking requirements can likely be met using private driveways and garages. In townhouse communities, if on-street parking is required, providing one on-street space per residence is likely sufficient. Urban settings will require the greatest use of on-street parking. However, continuous parking lanes on both sides of the street, while common for all residential land uses, is often unnecessary.

When on-street parking is necessary, queuing lanes provide a parking system alternative that minimizes imperviousness. Communities are using queuing lanes to narrow roads while also providing two-way traffic access. In a queuing lane design, one traffic lane is used by moving traffic and the parking lanes allow oncoming traffic to pull over and let opposite traffic pass (Center for Watershed Protection, 1998). Figure 5.7-2 shows traditional and queuing lane designs.

**Street Length**

Numerous factors influence street length including clustering techniques (discussed in a separate Chapter). As with street width, street length greatly impacts the overall imperviousness of a developed site. While no one prescriptive technique exists for reducing street length, alternative street layouts should be investigated for options to minimize impervious cover.

**Cul-de-sacs**

The use of cul-de-sacs introduces large areas of imperviousness into residential developments, with some communities requiring the cul-de-sac radius to be as large as 50 to 60 feet. In most instances, and in large radius cul-de-sac designs especially, the full area of the circle is neither necessary nor utilized. When cul-de-sacs are necessary, two primary alternatives can reduce their imperviousness.

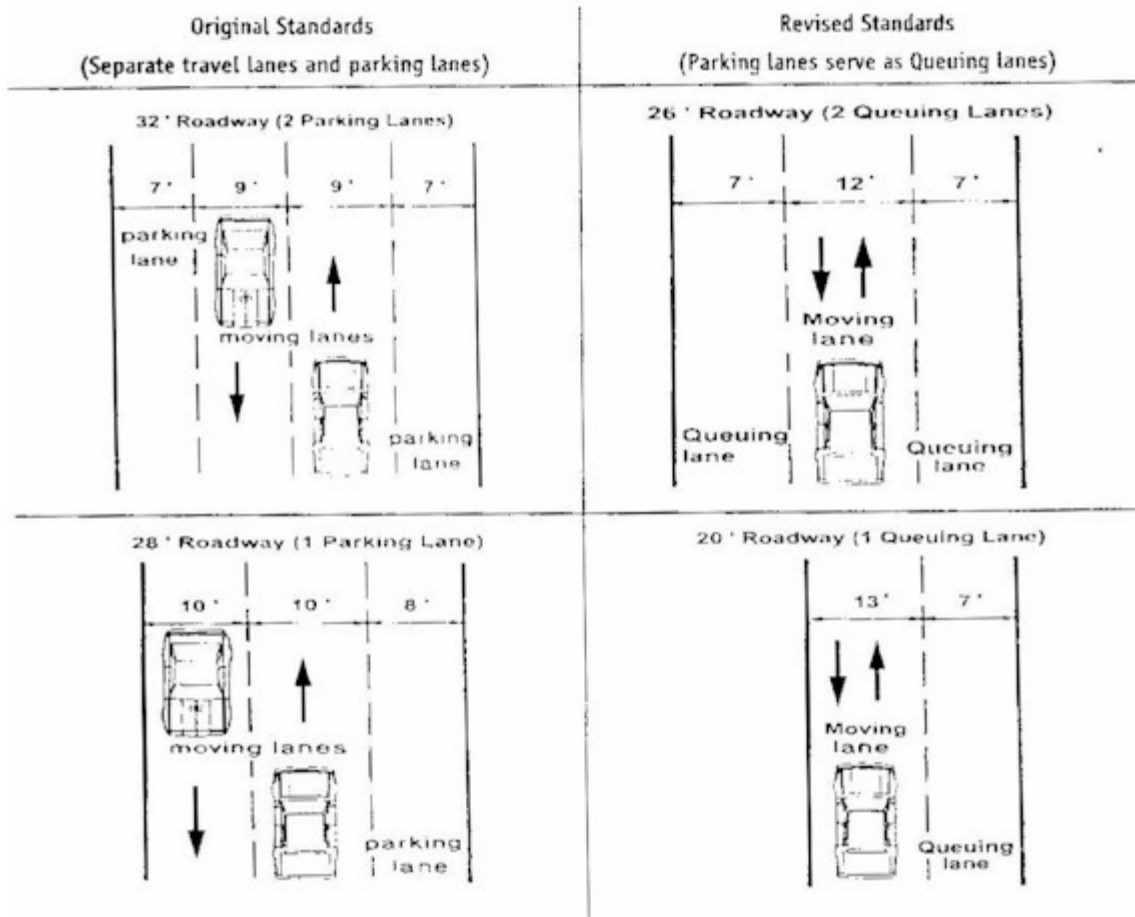


Figure 5.9-2 Traditional Streets vs. Traffic Queuing (Portland, Oregon Office of Transportation, 1994)

The first alternative is to reduce the required radius of the cul-de-sac. Many jurisdictions have identified required turnaround radii (shown in Table 5.7-3).

A second alternative is to incorporate a landscaped island into the center of the cul-de-sac. This design approach provides the necessary turning radius, minimizes impervious cover, and provides an aesthetic amenity to the community. In some instance, developments are placing bioretention cells (discussed in Chapter 6) in the center of cul-de-sacs to not only reduce imperviousness, but also provide a distributed method of treating stormwater runoff. Other cul-de-sac configurations have been developed which reduce impervious area.

## Cost Issues

### Street Width

Costs for paving have been estimated to be approximately \$15/yd<sup>2</sup> (Center for Watershed Protection, 1998). At this cost, for each one-foot reduction in street width, estimated savings are \$1.67 per linear foot of paved street. For example reducing the width of a 500-foot road by 5 feet would result in a savings of over \$4,100. This cost is exclusive of other construction costs including grading and infrastructure.

## Street Length

In addition to pavement, costs for street lengths, including traditional curb and gutter and stormwater management controls, are approximately \$150 per linear foot of road (Center for Watershed Protection, 1998). Decreasing road length by 100 feet can produce a savings of \$15,000. Simply factoring in pavement costs at \$15/yd<sup>2</sup>, a 100-foot length reduction in a 25-foot wide road would produce a savings in excess of \$4,000.

**Table 5.7-3: Example Cul-de-sac Turnaround Radii**

Source	Residential Street Width
Portland, Oregon Office of Transportation	35 ft. (with Fire Department Approval)
Buck County, Pennsylvania Planning Commission	38 ft. (outside turning radius)
Fairfax County, Virginia Fire and Rescue	45 ft.
Baltimore County, Maryland Fire Department	35 ft. (with Fire Department Approval)
Montgomery County, Maryland Fire Department	45 ft.
Prince George's County, Maryland Fire Department	43 ft.

(Adapted from Center for Watershed Protection, 1998)

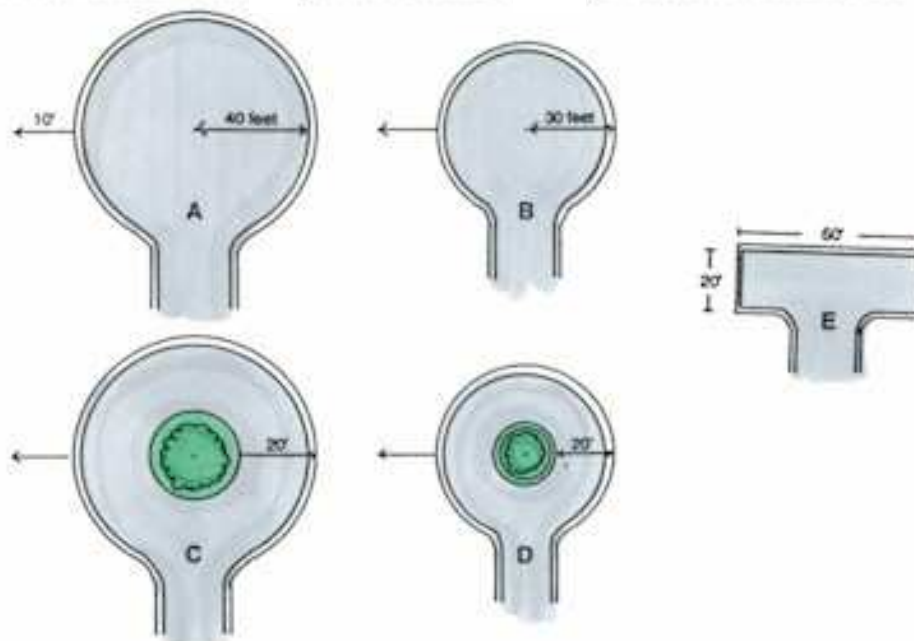


Figure 5.7-3 Five Turnaround Options for the end of a Residential Street, (“Better Site Design: A Handbook for Changing Development Rules in Your Community”, Center for Watershed Protection, August, 1998)

## BMP 5.7.2: Reduce Parking Imperviousness



Reduce imperviousness by minimizing imperviousness associated with parking areas.

### Key Design Elements

- Evaluate parking requirements considering average demand as well as peak demand.
- Consider the application of smaller parking stalls and/or compact parking spaces.
- Analyze parking lot layout to evaluate the applicability of narrowed traffic lanes and slanted parking stalls.
- Where appropriate, minimize impervious parking area by utilizing overflow parking areas constructed of pervious paving materials.

### Potential Applications

Residential: Yes  
 Commercial: Yes  
 Ultra Urban: Limited  
 Industrial: Yes  
 Retrofit: Limited  
 Highway/Road: Limited

### Stormwater Functions

Volume Reduction: Very High  
 Recharge: Very High  
 Peak Rate Control: Very High  
 Water Quality: High

### Water Quality Functions

TSS: Preventive  
 TP: Preventive  
 NO3: Preventive

## Description

Reducing parking imperviousness performs valuable stormwater functions in contrast to conventional or baseline development: Increasing infiltration; Decreasing stormwater runoff volume; Increasing stormwater time of concentration; Improving water quality by decreasing the pollutant loading of streams; Improving natural habitats by decreasing the deleterious effects of stormwater runoff; Decreasing the concentration and energy of stormwater. Imperviousness greatly influences stormwater runoff volume and quality by facilitating the rapid transport of stormwater and collecting pollutants from atmospheric deposition, automobile leaks, and additional sources. Increased imperviousness alters an area's hydrology, habitat structure, and water quality. Stream degradation has been witnessed at impervious levels as low as 10-20% (Center for Watershed Protection, 1995).

## Applications

In commercial and industrial areas, parking lots comprise the largest percentage of impervious area. Parking lot size is dictated by lot layout, stall geometry, and parking ratios. Modifying all or any of these three aspects can serve to minimize the total impervious areas associated with parking lots.

## Parking Ratios

Parking ratios express the specified parking requirements provided for a given land use. These specified ratios are often set as minimum requirements. Many developers seeking to ensure adequate parking provide parking in excess of the minimum parking ratios. Additionally, commercial parking is often provided to meet the highest hourly demand of a given site, which may only occur a few times per year. Excess parking is often rationalized by the desire to avoid potential complaints from patrons that have difficulty finding parking. However, as shown in Table 5.7-4, average parking demand is generally less than typical required parking ratios and therefore much less than parking provided in excess of these ratios. The result of using typically specified parking ratios is parking capacity that is underutilized.

**Table 5.7-4 Example Minimum Parking Ratios**

Land Use	Parking Ratio	Average Parking Demand
Single Family Home	2 spaces per dwelling unit	1.1 spaces per dwelling unit
Shopping Center	5 spaces per 1,000 ft <sup>2</sup> of GFA	3.97 spaces per 1,000 ft <sup>2</sup> of GFA
Convenience Store	3.3 spaces per 1,000 ft <sup>2</sup> of GFA	Not available
Industrial	1 space per 1,000 ft <sup>2</sup> of GFA	1.48 spaces per 1,000 ft <sup>2</sup> of GFA
Medical/Dental Office	5.7 spaces per 1,000 ft <sup>2</sup> of GFA	4.11 spaces per 1,000 ft <sup>2</sup> of GFA

GFA – gross floor area, excluding storage and utility space

(Institute of Transportation Engineers, 1987; Smith, 1984; Wells, 1994)

In residential neighborhoods, the perception of the need for large quantities of parking may lead developers to provide on-street parking; residential land use will greatly influence the quantity needed. Each on-street lane increases street impervious cover by 25%. Many communities require 2-2.5 parking spaces per residence. In single-lot neighborhoods, with both standard and reduced setbacks, parking requirements can likely be met using private driveways and garages. In townhouse communities, if on-street parking is required, providing one on-street space per residence is likely

sufficient. Urban settings will require the greatest use of on-street parking. However, continuous parking lanes on both sides of the street, while common for all residential land uses, is often unnecessary. When on-street parking is necessary, queuing lanes (discussed in BMP 5.7.1) provide a parking system alternative that minimizes imperviousness.

### Parking Spaces and Lot Layout

Parking spaces are comprised of five impervious components (Center for Watershed Protection, 1998):

1. The parking stall;
2. The overhang at the stall's edge;
3. A narrow curb or wheel stop;
4. The parking aisle that provides stall access; and
5. A share of the common impervious areas (e.g., fire lanes, traffic lanes).

Of these, the parking space itself accounts for approximately 50% of the impervious area, with stall sizes ranging from 160 to 190 ft<sup>2</sup>. Several measures can be taken to limit parking space size. First, jurisdictions can review standard parking stall sizes to determine their appropriateness. A typical stall dimension may be 10 ft by 18 ft, much larger than needed for many vehicles; while the largest SUVs are wider, the great majority of SUVs and vehicles are less than 7 ft providing opportunity for making stalls slightly narrower and shorter. In addition, typical parking lot layout includes parking aisles that accommodate two-way traffic and perpendicularly oriented stalls. The use of one-way aisles and angled parking stalls can reduce impervious area.

Jurisdictions can also stipulate that parking lots designate a percentage of stalls as compact parking spaces. Smaller cars comprise 40% or more of all vehicles and compact parking stalls create 30% less impervious cover than average-sized stalls (Center for Watershed Protection, 1998). This is currently an underutilized practice that has potential to reduce the total area of parking lots.

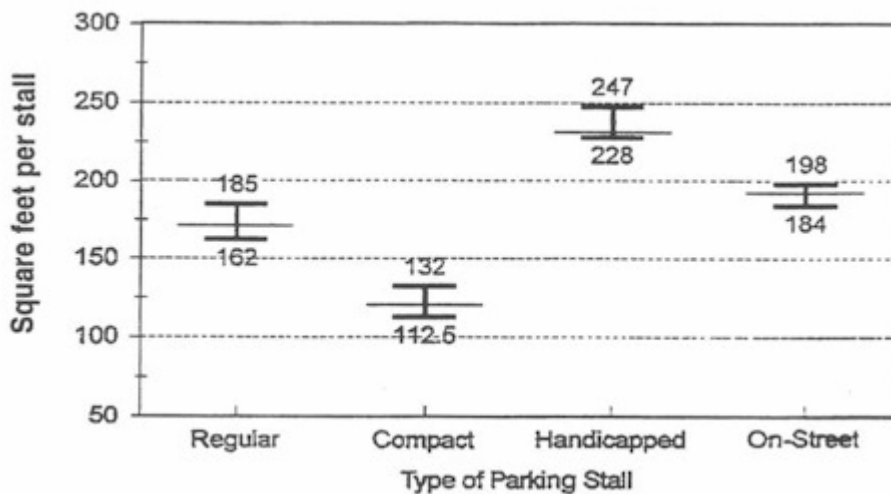


Figure 5.7-4 (“Conservation Design for Stormwater Management”, DNREC, 1997)

## Parking Lot Design

Because of parking ratio requirements and the desire to accommodate peak parking demand, even when it occurs only occasionally throughout the year, parking lots often provide parking capacity substantially in excess of average parking needs. This results in vast quantities of unused impervious surface.

A design alternative to this scenario is to provide designated overflow parking areas. The primary parking area, sized to meet average demand, would still be constructed on impervious pavement to meet local construction codes and American with Disabilities Act requirements. However, the overflow parking area, designed to accommodate increased parking requirements associated with peak demand, would be constructed on pervious materials (e.g., permeable pavers, grass pavers, gravel). This design approach focused on average parking demand will still meet peak parking demand requirements while reducing impervious pavement.



*Figure 5.10-2 Overflow parking using permeable pavers*

## Cost Issues

Estimates for parking construction range from \$1,200 to \$1,500 dollars per space (Center for Watershed Protection, 1998). For example, assuming a cost of \$1,200 per parking space, reducing the required parking ratio for a 20,000 ft<sup>2</sup> shopping center from 5 spaces per 1,000 ft<sup>2</sup> to 4 spaces per 1,000 ft<sup>2</sup> would represent a savings of \$24,000.

Parking lots incorporating pervious overflow areas may not present cost savings, as permeable paving products are generally more expensive than traditional asphalt. However, the additional costs may be offset by reduced curb and gutter and stormwater management costs.



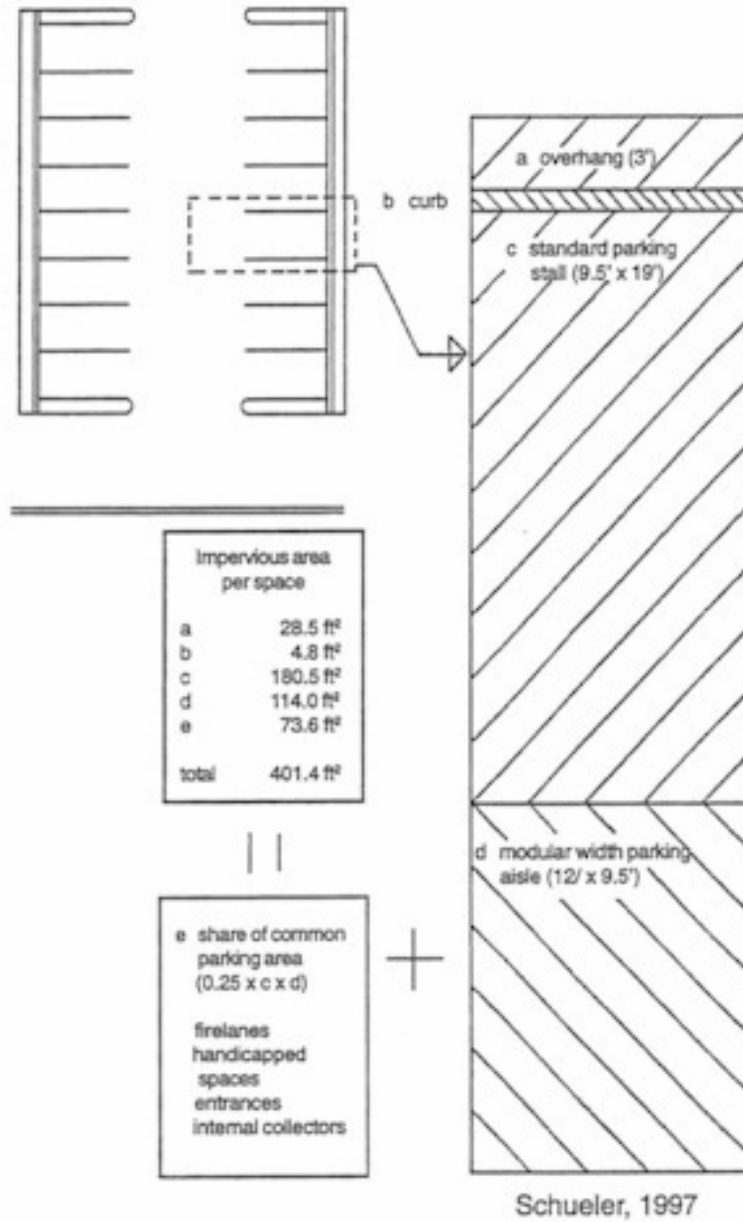


Figure 5.7-5 Parking Stall Dimensions (Schueler, 1997)

## References

Center for Watershed Protection, 1998  
Center for Watershed Protection, 1995

## **5.8 Disconnect/Distribute/Decentralize**



# BMP 5.8.1: Rooftop Disconnection



Minimize stormwater volume by disconnecting roof leaders and directing rooftop runoff to vegetated areas to infiltrate.

<p style="text-align: center;"><b><u>Key Design Elements</u></b></p> <ul style="list-style-type: none"> <li>▪ Stormwater collection systems.</li> <li>▪ Redirect rooftop overland flow to minimize rapid transport to conveyance structures and impervious areas, such as ditches and roadways.</li> <li>▪ Direct runoff to vegetated areas designed to receive stormwater.</li> </ul>	<p style="text-align: center;"><b><u>Potential Applications</u></b></p> <p>Residential: Yes          Commercial: Yes          Ultra Urban: Limited          Industrial: Limited          Retrofit: Limited          Highway/Road: Limited</p>
	<p style="text-align: center;"><b><u>Stormwater Functions</u></b></p> <p>Volume Reduction: High          Recharge: High          Peak Rate Control: High          Water Quality: Low</p>
	<p style="text-align: center;"><b><u>Water Quality Functions</u></b></p> <p>TSS: 30%          TP: 0%          NO3: 0%</p>

## Description

Traditionally, building codes have encouraged the rapid conveyance of rooftop runoff away from building structures. It is not uncommon for municipal codes to specify minimum slopes which serve to accelerate overland flow onto and across yards and lawns, directed ever more rapidly toward streets and gutters. Concerns pertaining to surface ponding of rooftop stormwater and potential ice formation on sidewalks and driveways are the main drivers of these lot requirements (Center for Watershed Protection, 1998). These requirements, stemming from a convention of rapid transmission of stormwater, serve to discourage on-site treatment of rooftop stormwater. This trend is further exacerbated in northern latitudes where icing concerns are paramount and, consequently, where downspouts may be connected directly to the stormwater collection system.

Disconnecting roof leaders from conventional stormwater conveyance systems allows rooftop runoff to be collected and managed on site. Rooftop runoff can be directed to designed vegetated areas (discussed in Chapter 6) for on-site storage, treatment, and volume control. This BMP offers a distributed, low-cost method for reducing runoff volume and improving stormwater quality through:

- Increasing infiltration and evapotranspiration.
- Increasing filtration.
- Decreasing stormwater runoff volume.
- Increasing stormwater time of concentration.

## Variations

In addition to directing rooftop runoff to vegetated areas, runoff may also be discharged to non-vegetated BMPs, such as dry wells, rain barrels, and cisterns for stormwater retention and volume reduction. With proper design, this rooftop water can be used for lawn watering, gardening, toilet flushing and fire protection.

## Applications

Routing rooftop runoff to naturally vegetated areas will reduce runoff volume and peak discharge, as well as improve water quality by slowing runoff, allowing for filtration, and providing opportunity for infiltration and evapotranspiration. The use of pervious areas for rooftop discharge has the ability to reduce the quantity of site stormwater runoff and improve the quality of the stormwater that does discharge from the site. Alternatives for disconnecting roof leaders and the use of vegetated areas should consider the following issues (Prince George's County Department of Environmental Protection, 1997; Maryland Department of the Environment, 1997).

- Encourage shallow sheet flow through vegetated areas, using flow spreading and leveling devices if necessary.
- Direct roof leader flow into BMPs designed specifically to receive and convey rooftop runoff.
- Direct flows into stabilized vegetated areas, including on-lot swales and bioretention areas.
- Rooftop runoff may also be directed to on-site depression storage areas.
- Runoff from industrial roofs and similar uses should not be directed to vegetated areas, if there is reason to believe that pollutant loadings will be elevated.
- Limit the contributing rooftop area to a maximum of 500 ft<sup>2</sup> per downspout.
- Flow from roof leaders should not contribute to basement seepage.

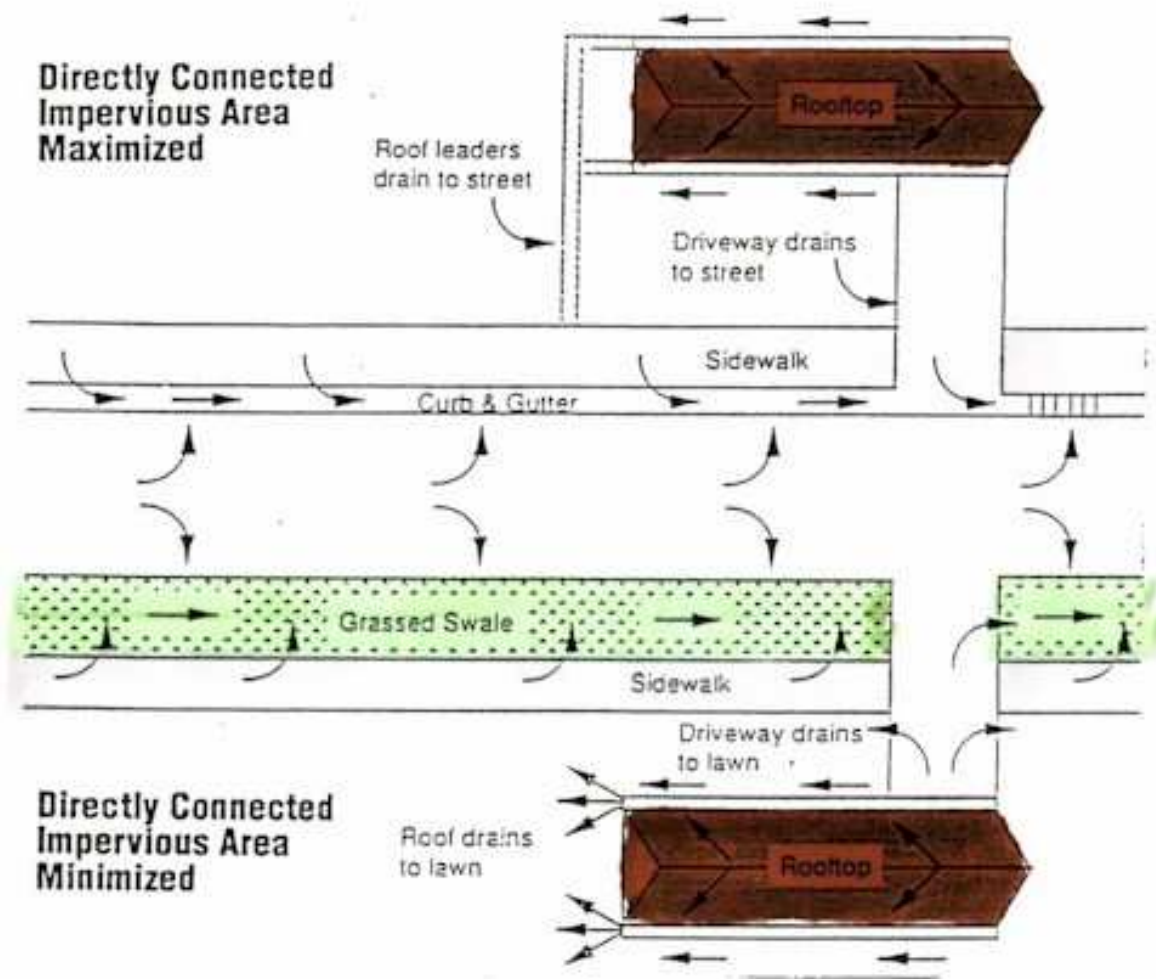


Figure 5.8-1 Examples of Directly Connected Impervious Areas (Roesner, ASCE, 1991)

Careful consideration should be given to the design of vegetated collection areas. Concerns pertaining to basement seepage and water-soaked yards are not unwarranted, with the potential arising for saturated depressed areas and eroded water channels. The proper design and use of bioretention areas, infiltration trenches, and/or dry wells will reduce or eliminate the potential of surface ponding and facilitate functioning during cold weather months.

Maintenance of the planted areas would be required, but would be limited. Routine maintenance would include a biannual health evaluation of the vegetation and subsequent removal of any dead or diseased vegetation plus mulch replenishment, if included in the design. This maintenance can be incorporated into regular maintenance of the site landscaping. If the vegetated area is located in a residential neighborhood, the maintenance responsibility could be delegated to the residents. The use of native plant species in the vegetated area will reduce fertilizer, pesticide, water, and overall maintenance requirements.

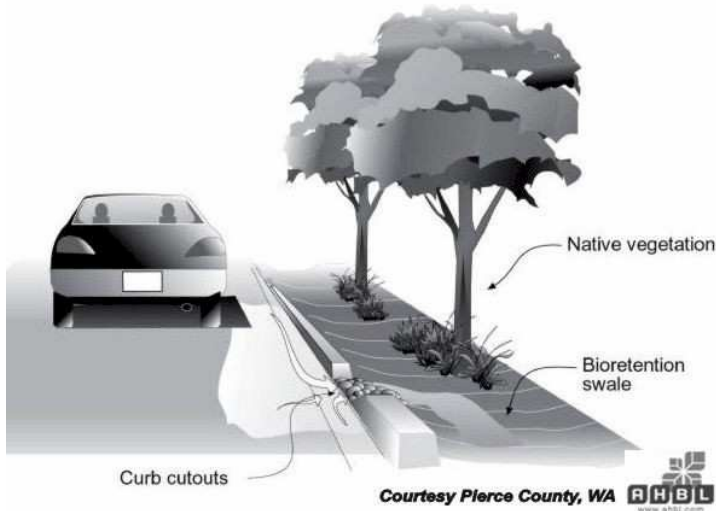
## **Cost Issues**

Construction cost estimates for vegetated areas should be similar or in line with that of conventional landscaping. If bioretention areas are incorporated into the site, their costs are slightly more than costs required for conventional landscaping. Commercial, industrial, and institutional site costs range between \$10 and \$40 per square foot, based on the design of the bioretention area and the control structures included. These costs, however, can potentially be offset by the reduced costs of conventional stormwater management systems that otherwise would be required, if it were not for the reduction achieved through the application of this BMP.

## **References**

Prince George's County Department of Environmental Protection, 1997  
Maryland Department of the Environment, 1997  
Center for Watershed Protection, 1998

# BMP 5.8.2: Disconnection from Storm Sewers



Minimize stormwater volume by disconnecting impervious roads and driveways and directing runoff to grassed swales and/or bioretention areas to infiltrate.

<p style="text-align: center;"><b><u>Key Design Elements</u></b></p> <ul style="list-style-type: none"> <li>▪ Disconnect road and driveways from stormwater collection systems.</li> <li>▪ Redirect road and driveway runoff into grassed swales or other vegetated systems designed to receive stormwater.</li> <li>▪ Eliminate curbs/gutters/conventional collection and conveyance.</li> </ul>	<p style="text-align: center;"><b><u>Potential Applications</u></b></p> <p>Residential: Yes  Commercial: Ultra Yes  Urban: Industrial: Limited  Retrofit: Limited  Highway/Road: Limited</p>
<p style="text-align: center;"><b><u>Stormwater Functions</u></b></p> <p>Volume Reduction: High  Recharge: High  Peak Rate Control: High  Water Quality: Low</p>	<p style="text-align: center;"><b><u>Water Quality Functions</u></b></p> <p>TSS: 30%  TP: 0%  NO3: 0%</p>



## Description

Impervious roads and driveways account for a large percentage of post-development imperviousness. These surfaces influence stormwater runoff volume and quality by facilitating the rapid transport of stormwater and collecting pollutants from atmospheric deposition, automobile leaks, and additional sources. Considered a source of more potentially damaging pollution than rooftops, roads and driveways contribute toxic chemicals, oil, and metals to stormwater runoff.

Conventional stormwater management has involved the rapid removal and conveyance of stormwater from these surfaces. The result of this management system has been increased runoff volume, decreased time of concentration, and greater pollutant mobility. Distributed stormwater management through the use of vegetated swales and bioretention areas (discussed in Section 6.4.8 and 6.4.5) can reduce the volume of stormwater runoff while providing on-site treatment and pollutant removal, providing:

- Increased infiltration and evapotranspiration.
- Increased filtration.
- Decreased stormwater runoff volume.
- Increased stormwater time of concentration.

## Variations

A variety of alternatives exist for redirecting road and driveway runoff away from stormwater collection systems. In addition to vegetated swales, infiltration trenches or bioretention areas may be utilized. Curbing may be eliminated entirely or selectively eliminated, as shown in Figure 5.8-2. The choice of BMP will depend upon site-specific characteristics including soil type, slope, and stormwater volume.

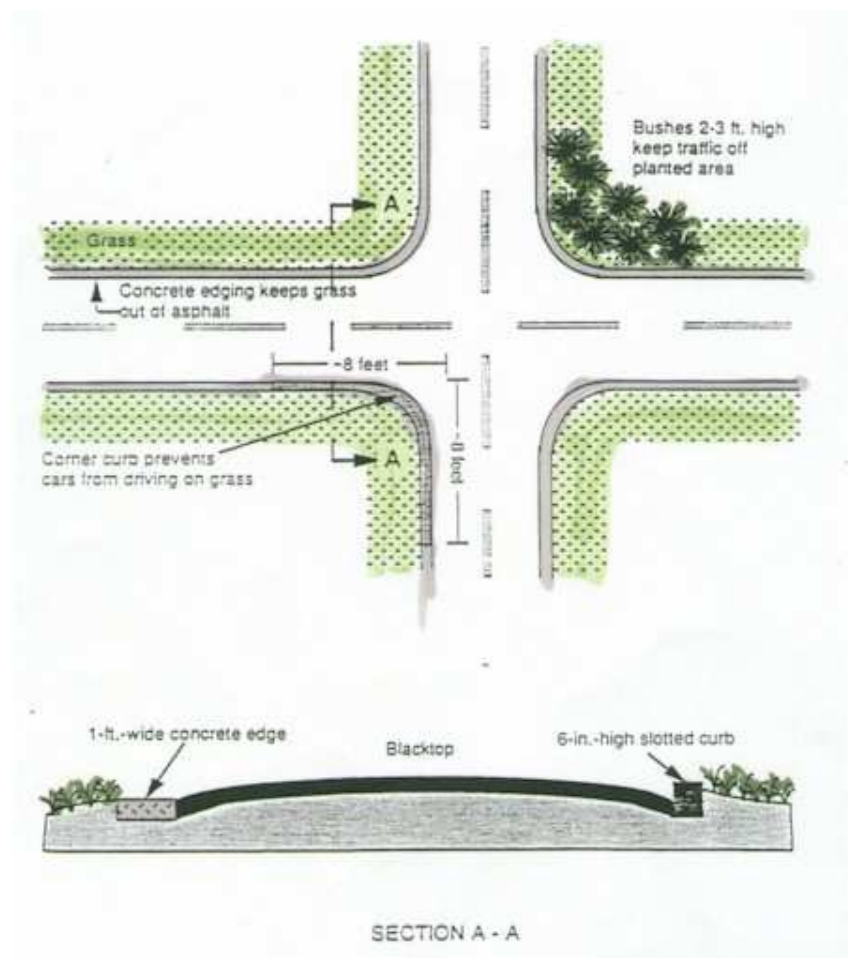


Figure 5.8-2 Example of Concrete Road Edging and Corner Curb (Roesner, ASCE, 1991)

## Applications

Routing road and driveway runoff to vegetated swales will reduce runoff volume and peak discharge, as well as improve water quality by slowing runoff, allowing for filtration, and providing opportunity for infiltration and evapotranspiration. Most importantly, in contrast to conventional systems where roads and driveways are connected directly to the stormwater collection and conveyance system, vegetated swales offer the potential for pollutant reductions (see additional discussion in Section 6.8). When stormwater enters the stormwater system directly from road and driveways surfaces, a large variety of pollutants are introduced into the stormwater and eventually the receiving stream. These pollutants include toxic chemicals, oil, metals, and large particulate matter.

The use of vegetated swales, while slowing runoff discharge and permitting infiltration, also allows for pollutant reduction facilitated by the soil media complex and plant uptake. Thus, vegetated swales used in this manner serve a range of functions, intercepting runoff, reducing stormwater volume, and retaining and reducing pollutants. Proper design and implementation still allows stormwater to be quickly removed from road and driveway surfaces alleviating concerns over standing water.

The suitability of vegetated swales depends on land use, soil type, imperviousness of the contributing watershed, and dimensions and slope of the vegetated swale system. Use of natural low-lying areas is encouraged and natural drainage courses should be preserved and utilized.

Maintenance of the vegetated swale should include providing sufficient capacity of the channel and maintaining a dense, healthy vegetated cover. Maintenance activities should include periodic mowing (with plantings never cut shorter than the design flow depth), weed control, watering during drought conditions, reseeding of bare areas, and clearing of debris and blockages.

## Cost Issues

See discussion in Chapter 6.4.8. Vegetated swale construction costs are estimated at approximately \$0.25 per ft<sup>2</sup>. By including design costs, this estimated cost increases to \$0.50 per ft<sup>2</sup>, allowing vegetated swales to compare favorably with other stormwater management practices.



## **5.9 Source Control**



## BMP 5.9.1: Streetsweeping



Use of one of several modes of sweeping equipment (e.g., mechanical, regenerative air, or vacuum filter sweepers) on a programmed basis to remove larger debris material and smaller particulate pollutants, preventing this material from clogging the stormwater management system and washing into receiving waterways/waterbodies.

<p style="text-align: center;"><b><u>Key Design Elements</u></b></p> <ul style="list-style-type: none"> <li>▪ Use proper equipment; dry vacuum filters demonstrate optimal results, significantly better than mechanical and regenerative air sweeping, though move slowly and are most costly</li> <li>▪ Develop a proper program; vary sweeping frequency by street pollutant load (a function of road type, traffic, adjacent land uses, other factors); sweep roads with curbs/gutters</li> <li>▪ Develop a proper program; restrict parking when sweeping to improve removal.</li> <li>▪ Develop a proper program; seasonal variation for winter applications as necessary.</li> </ul>	<p style="text-align: center;"><b><u>Potential Applications</u></b></p> <p>Residential: Yes  Commercial: Yes  Ultra Urban: Yes  Industrial: Yes  Retrofit: Yes  Highway/Road: Yes</p>
<p style="text-align: center;"><b><u>Stormwater Functions</u></b></p> <p>Volume Reduction: Low/None  Recharge: Low/None  Peak Rate Control: Low/None  Water Quality: High</p>	<p style="text-align: center;"><b><u>Water Quality Functions</u></b></p> <p>TSS: 85%  TP: 85%  NO3: 50%</p>

## Description

National Urban Runoff Program (NURP) studies from the 1980's reported generally very poor results from street sweeping. In some cases, results suggested that water quality effects of conventional mechanical street sweeping programs were actually negative. This is possibly explained by the fact that the superficial sweeping accomplished by mechanical sweepers removes a "crust" of large, coarser debris on many surfaces and exposes the finer particles to upcoming storm events. These particles are then washed into receiving water bodies. However, new street sweeping technology (see discussion below) has dramatically improved street sweeping performance. While these new street sweeping technologies are considerably more costly than previous street sweeping technologies, their pollutant reduction performance compares quite favorably to other pollutant reduction BMPs. Streetsweeping can actually be quite cost effective in terms of water quality performance.

## Variations

Variations in street sweeping relate primarily to differences in equipment but also relate to important aspects of the street sweeping programs, such as frequency of street sweeping, use of regulations such as parking prohibitions, and other program factors.



Figure 5.13-1 Vacuum Filter Street sweeper

## Equipment -

**Mechanical broom:** use of mechanical brooms/brushes with conveyor belts. Designed to remove standard road debris, using various types of circulating brushes that sweep material onto conveyors and then into bins. Some machines apply water to reduce dust. Includes the Elgin Pelican (3-wheel) and Eagle (4-wheel), Athey's Mobile (3- and 4-wheel) and Schwarze M-series. Stormwater reports that the vast bulk of sweepers in use in the US are of this type. These sweepers are least expensive and vary in cost from (approximately \$60,000 in 2002, according to Stormwater magazine).

**Regenerative air:** compressed air is directed onto the road surface, loosening fine particles that are then vacuumed. Includes Elgin's Crosswind J, Mobile's RA730 series, Schwarze's A-series, Tymco sweepers. About twice as expensive as mechanical sweepers (\$120,000 in 2002, according to Stormwater magazine).

**Vacuum filter:** vacuum assisted small-micron particle sweepers, either wet or dry. Dry vacuum includes mechanical broom sweeping with a vacuum (Elgion's GeoVac and Whirlwind models and Schwarze's EV-series particulate management); this technology works well even in cold weather conditions. Wet vacuum uses water dust suppression with scrubbers that apply water to pavement; particles are suspended, and then vacuumed. Four to 5 times as expensive as mechanical sweepers, according to Stormwater magazine in 2002. Equipment has been constrained by slow driving speeds (max of 25 mph).

**Tandem sweeping:** using two machines, surfaces are mechanically swept and then vacuumed.

## Applications

Streetsweeping programs vary by sweeping frequency that in turn depends on several other factors. Certainly the most obvious factor is the intensity of the roadway and its expected pollutant load – the greater the traffic intensity, the greater the pollutant load. Other factors such as frequency and intensity of rainfall also affect desired street sweeping frequency. Sutherland and Jelen (1997), measuring sediment load reduction, found very high pollutant load reduction with weekly or greater sweeping frequencies in the Portland area with relatively frequent rainfall events.

Another factor to consider in street sweeping programs is “wash-on” or material that washes onto impervious areas from upgradient/upstream pervious surfaces. Obviously if large amounts of sediment and related-pollutants wash onto the paved surfaces during storm events themselves, street sweeping is going to be relatively ineffective. The Center for Watershed Protection maintains that as site imperviousness itself increases and as the imperviousness of upgradient watershed areas increases, potential for wash-on decreases and potential effectiveness of street sweeping increases (Article 121, Center for Watershed Protection *Technical Note 103 from Watershed Protection Techniques 3(1)*, pp. 601-604).

Lastly, pollutant loads being contributed by the rainfall itself, or wetfall (such as total solids, total nitrogen, chemical oxygen demand, extractable copper) will not be reduced or removed through street sweeping by definition. For example, research performed by the Metropolitan Washington Council of Governments found that 34 percent of total nitrogen, 24 percent of total solids, and 18 percent of COD occurred as wetfall (Urban Runoff in the Washington Metropolitan Area, 1983. Final Report: Washington DC Area Urban Runoff Project. USEPA Nationwide Urban Runoff Program, MWCOG Washington DC).

In general, the greater the traffic on a roadway and the greater the number of vehicles using a parking area, the greater the pollutant loads. The greater the pollutant loads, the greater the potential effectiveness of street sweeping. Winter road applications affect street sweeping programs

## Cost Issues

Costs of street sweeping include capital costs of purchasing the equipment, annual costs of maintenance, annual costs of operation, plus costs of disposal of the material that is collected. According to the US Environmental Protection Agency's *Preliminary Data Summary of Urban Storm Water Best Management Practices* (August 1999, EPA-821-R-99-012), street sweeper costs are quite variable. A mechanical sweeper with \$75,000 purchase price and a 5-year life cycle was found to cost \$30 per curb mile (Finley, 1996 and SWRPC, 1991), while a vacuum street sweeper purchased at \$150,000 and having an 8-year life cycle cost \$15 per curb mile (Satterfield, 1996 and SWRPC, 1991). Further comparisons were made by the EPA, including the effects of varying frequency of sweeping (USEPA, 1999).

The point is that although mechanical sweepers are less expensive than vacuum sweepers, their economic life is shorter than vacuum sweepers. If pollutant removal effectiveness is included in the comparison, vacuum sweepers yield substantially better cost effectiveness in most cases.



## Pollutant Removal Performance

Although pollutant removal performance for street sweeping will vary with the frequency of the street sweeping program, evaluations are demonstrating remarkably high pollutant removal, especially if the program includes weekly street sweeping. The Center for Watershed Protection reports one recent study with 45-65 percent removal of total suspended solids, 30-55 percent total phosphorus, 35-60 percent total lead, 25-50 percent total zinc, and 30-55 percent total copper (Kurahashi & Associates, Inc. 1997. *Port of Seattle, Stormwater Treatment BMP Evaluation*). In *Street Sweeping for Pollutant Removal* (Montgomery County Department of Environmental Protection, Montgomery County, Maryland, February 2002), additional pollutant removal effectiveness data is reported from studies performed by the Center for Watershed Protection (*Watershed Treatment Model*, 2001). Total suspended solids reduction ranged from 5 percent (major road) and 30 percent (residential street) for mechanical sweepers to 22 and 64 percent respectively for regenerative air and 79 to 78 percent respectively for vacuum sweepers. For nitrogen, mechanical sweeper pollutant removal was 4 and 24 percent removal for major roads and residential streets, regenerative air was 18 and 51 percent, and vacuum 53 and 62 percent. In summary, although pollutant removal performance for new mechanical sweepers has improved considerably over those of the past generation, the new vacuum technology is significantly better than either mechanical or even regenerative air sweepers and achieves a level of pollutant removal that is frequently better than all other BMPs.

## References

Center for Watershed Protection, 2001. *Watershed Treatment Model*.

Center for Watershed Protection, *Article 121: Technical Note 103 from Watershed Protection Techniques 3(1)*, pp. 601-604

Finley, 1996 and SWRPC, 1991

Kurahashi & Associates, Inc. 1997. *Port of Seattle, Stormwater Treatment BMP Evaluation*.

Montgomery County Department of Environmental Protection, 2002. *Street Sweeping for Pollutant Removal*, Montgomery County, MD.

Satterfield, 1996 and SWRPC, 1991

Sutherland and Jelen, 1997.

USEPA, 1999. *Preliminary Data Summary of Urban Storm Water Best Management Practices*

Urban Runoff in the Washington Metropolitan Area, 1983. Final Report: Washington DC Area Urban Runoff Project. USEPA Nationwide Urban Runoff Program, MWCOG Washington DC



---

# **Pennsylvania Stormwater Best Management Practices Manual**

---

## **Chapter 6**

### **Structural BMPs**





**Chapter 6 Structural BMPs**

**6.1 Introduction.....1**

**6.2 Groupings of Structural BMPs.....1**

**6.3 Manufactured Products.....2**

**6.4 Volume/Peak Rate Reduction by Infiltration BMPs.....5**

**BMP 6.4.1 Pervious Pavement with Infiltration Bed.....7**

**BMP 6.4.2 Infiltration Basin.....27**

**BMP 6.4.3 Subsurface Infiltration Bed.....33**

**BMP 6.4.4 Infiltration Trench.....41**

**BMP 6.4.5 Rain Garden / Bioretention.....49**

**BMP 6.4.6 Dry Well / Seepage Pit.....61**

**BMP 6.4.7 Constructed Filter.....71**

**BMP 6.4.8 Vegetated Swale.....83**

**BMP 6.4.9 Vegetated Filter Strip.....99**

**BMP 6.4.10 Infiltration Berm & Retentive Grading.....113**

**6.5 Volume/Peak Rate Reduction BMPs.....123**

**BMP 6.5.1 Vegetated Roof.....125**

**BMP 6.5.2 Runoff Capture & Reuse.....139**

**6.6 Runoff Quality/Peak Rate BMPs.....149**

**BMP 6.6.1 Constructed Wetland.....151**

**BMP 6.6.2 Wet Pond/ Retention Basin.....163**

**BMP 6.6.3 Dry Extended Detention Basin.....173**

**BMP 6.6.4 Water Quality Filters & Hydrodynamic Devices.....183**

**6.7 Restoration BMPs.....189**

**BMP 6.7.1 Riparian Buffer Restoration. ....191**

**BMP 6.7.2 Landscape Restoration.....211**

**BMP 6.7.3 Soils Amendment & Restoration.....221**

**BMP 6.7.4 Floodplain Restoration.....231**

**6.8 Other BMPs and Related Structural Measures.....241**

**BMP 6.8.1 Level Spreader.....243**

**BMP 6.8.2 Special Detention Areas – Parking Lot, Rooftop.....253**



## 6.1 Introduction

Twenty-one Structural BMPs are listed and described in this chapter. As indicated in both Chapters 4 and 5, many of these “structures” are natural system-based and include vegetation and soils mechanisms as part of their functioning. More conventional “bricks and mortar” structures are also included in this chapter.

Several of the BMPs presented in this chapter lead to variations on a central theme. The vegetated swale is a good example of a core BMP that fosters numerous others. These variations have been included in this chapter with some explanation and reference made as to how and when such variations can be successfully applied. As lengthy as the list of Structural BMPs might be, many more BMPs are expected to emerge as stormwater management practices continue to evolve and mature. Each BMP is outlined using approximately the same structure or outline as has been applied to the Non-Structural BMPs.

## 6.2 Groupings of Structural BMPs

Structural BMPs are grouped according to the primary, though not exclusive, stormwater functions, as follows:

- Volume/Peak Rate Reduction by Infiltration BMPs**
- Volume/Peak Rate Reduction BMPs**
- Runoff Quality/Peak Rate BMPs**
- Restoration BMPs**
- Other BMPs**

In all cases, these stormwater functions are linked to the Recommended Site Control Guidelines presented in Chapter 3. Most of the Structural BMPs fall into the category of Volume/Peak Rate Reduction. Some of these BMPs also possess excellent water quality protection capabilities as well. Volume and Peak Rate functions also can be provided by a smaller group of increasingly important Structural BMPs such as Vegetated Roofs and Roof Capture/Reuse (e.g., rain barrels and cisterns). Certain BMPs provide water quality and peak rate control functions, without any significant control of volume. The Restoration BMPs and Other BMP categories provide a mix of stormwater functions. Although these BMPs have not been frequently used in the past, they can offer real potential for many Pennsylvania municipalities in the future.

Lastly, two special lists of instructions, or Protocols, have been developed specifically for use with all infiltration-oriented structural BMPs and are presented in Appendix C.

- Protocol 1: Site Evaluation and Soil Infiltration Testing**
- Protocol 2: Infiltration Systems Design and Construction Guidelines**

These Protocols should be followed whenever infiltration-oriented BMPs are being developed. The Protocols set forth a variety of actions common to all infiltration BMPs. These actions should be taken to ensure that proper site conditions and constraints are being addressed, proper design considerations are being taken, and proper construction specifications are being integrated into the overall design of the BMP. An especially important aspect of these instructions focuses on full and careful testing of the soil, thereby necessitating a separate Protocol that addresses soil testing and analysis. If these Protocols are followed, the risk of failed infiltration BMPs will be minimized, if not eliminated.

One of the most challenging technical issues considered in this manual involves the selection of BMPs with a high degree of pollutant reduction or removal efficiency. The Non-Structural BMPs described in Chapter 5 and the Structural BMPs presented in Chapter 6 are all rated in terms of their pollutant removal performance or effectiveness. The initial BMP selection process analyzes the final site plan and estimates the potential pollutant load, using Appendix A. The targeted reduction percentage for representative pollutants (such as 85% reduction in TSS and TP load and 50% reduction in the solute load) is achieved by a suitable combination of Non-Structural and Structural BMPs. This process is described in more detail in Chapter 8.

### 6.3 Manufactured Products

A variety of product suppliers, distributors, and manufacturers have provided extensive product information to PADEP during the preparation of this manual. Many of these products can be used in conjunction with the Non-Structural BMPs set forth in Chapter 5 as well as the Structural BMPs presented in this chapter. The proper application and use of many of these manufactured products can further the stormwater management goals and objectives of this manual. It should be noted that Pennsylvania does not have an established product review and testing function. The interested reader/user is directed to the following sources to learn about the performance of a specific product or technology:

The Technology Acceptance Reciprocity Partnership (TARP) – A partnership of the states of California, Illinois, Maryland, Massachusetts, New Jersey, New York, Pennsylvania and Virginia that establishes standardized methods to guide the collection and evaluation of new and innovative technology performance across the states. Information is available at: [www.dep.state.pa.us/dep/deputate/pollprev/techservices/tarp/index.htm](http://www.dep.state.pa.us/dep/deputate/pollprev/techservices/tarp/index.htm)

Environmental Technology Evaluation Center (EvTEC) of The Civil Engineering Research Foundation (CERF), including their Stormwater Best Management Practices (BMPs) Verification Program - information available at <http://www.cerf.org/evtec/index.htm> & [http://www.cerf.org/evtec/eval/wsdot\\_qr.htm](http://www.cerf.org/evtec/eval/wsdot_qr.htm)

U.S. EPA's Environmental Technology Verification Program (ETV) - information available at <http://www.epa.gov/etv/>

The University of New Hampshire's Center for Stormwater Technology Evaluation and Verification (CSTEV) - information available at <http://www.unh.edu/erg/cstev/index.htm#>

The Chesapeake Bay Program's Innovative Technology Task Force (ITTF) - information about the program as well as many useful links to other programs available at [http://www.chesapeakebay.net/info/innov\\_tech.cfm](http://www.chesapeakebay.net/info/innov_tech.cfm)

New Jersey's Energy and Environmental Technology Verification Program - results available through the New Jersey Corporation for Advanced Technology (NJCAT) at <http://www.njcat.org/>

*Disclaimer: The technology descriptions contained in this document including, but not limited to, information on technology applications, performance, limitations, benefits, and cost, have been provided by vendors. No attempt was made to examine, screen or verify company or technology information. The Pennsylvania Department of Environmental Protection has not confirmed the*



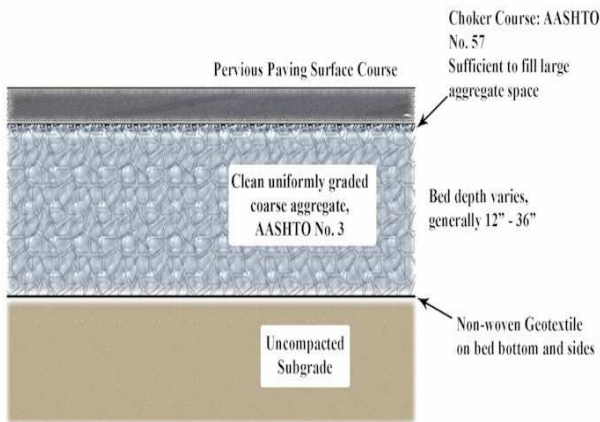
*accuracy or legal adequacy of any disclosures, product performance, or other information provided by the companies appearing here. The inclusion of specific products in this document does not constitute or imply their endorsement or recommendation by the Pennsylvania Department of Environmental Protection.*



## **6.4 Volume/Peak Rate Reduction by Infiltration BMPs**



## BMP 6.4.1: Pervious Pavement with Infiltration Bed



Pervious pavement consists of a permeable surface course underlain by a uniformly-graded stone bed which provides temporary storage for peak rate control and promotes infiltration. The surface course may consist of porous asphalt, porous concrete, or various porous structural pavers laid on uncompacted soil.

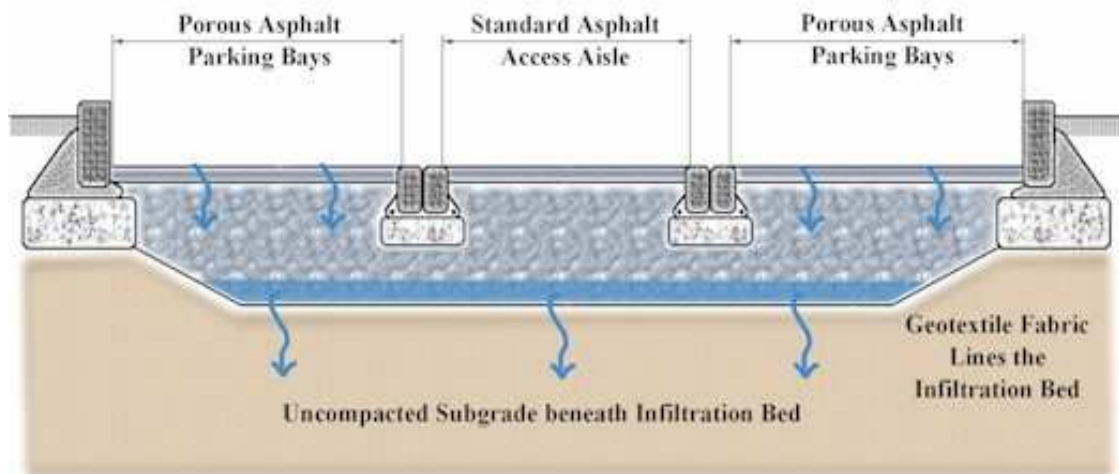
<p style="text-align: center;"><b><u>Key Design Elements</u></b></p> <ul style="list-style-type: none"> <li>▪ Almost entirely for peak rate control</li> <li>▪ Water quality and quantity are not addressed</li> <li>▪ Short duration storage; rapid restoration of primary uses</li> <li>▪ Minimize safety risks, potential property damage, and user inconvenience</li> <li>▪ Emergency overflows</li> <li>▪ Maximum ponding depths</li> <li>▪ Flow control structures</li> <li>▪ Adequate surface slope to outlet</li> </ul>	<p style="text-align: center;"><b><u>Potential Applications</u></b></p> <p>Residential: Limited                  Commercial: Yes                  Ultra Urban: Yes                  Industrial: Yes                  Retrofit: Yes                  Highway/Road: Limited</p>
	<p style="text-align: center;"><b><u>Stormwater Functions</u></b></p> <p>Volume Reduction: Medium                  Recharge: Medium                  Peak Rate Control: Medium                  Water Quality: Medium</p>
	<p style="text-align: center;"><b><u>Water Quality Functions</u></b></p> <p>TSS: 85%                  TP: 85%                  NO3: 30%</p>

**Other Considerations**

- **Protocol 1. Site Evaluation and Soil Infiltration Testing** and **Protocol 2. Infiltration Systems Guidelines** should be followed, see Appendix C

### Description

A pervious pavement bed consists of a pervious surface course underlain by a stone bed of uniformly graded and clean-washed coarse aggregate, 1-1/2 to 2-1/2 inches in size, with a void space of at least 40%. The pervious pavement may consist of pervious asphalt, pervious concrete, or pervious pavement units. Stormwater drains through the surface, is temporarily held in the voids of the stone bed, and then slowly drains into the underlying, uncompacted soil mantle. The stone bed can be designed with an overflow control structure so that during large storm events peak rates are controlled, and at no time does the water level rise to the pavement level. A layer of geotextile filter fabric separates the aggregate from the underlying soil, preventing the migration of fines into the bed. The bed bottoms should be level and uncompacted. If new fill is required, it should consist of additional stone and not compacted soil.



Pervious pavement is well suited for parking lots, walking paths, sidewalks, playgrounds, plazas, tennis courts, and other similar uses. Pervious pavement can be used in driveways if the homeowner is aware of the stormwater functions of the pavement. Pervious pavement roadways have seen wider application in Europe and Japan than in the U.S., although at least one U.S. system has been constructed. In Japan and the U.S., the application of an open-graded asphalt pavement of 1" or less on roadways has been used to provide lateral surface drainage and prevent hydroplaning, but these are applied over impervious pavement on compacted sub-grade. This application is not pervious pavement.

Properly installed and maintained pervious pavement has a significant life-span, and existing systems that are more than twenty years in age continue to function. Because water drains through the surface

course and into the subsurface bed, freeze-thaw cycles do not tend to adversely affect pervious pavement.

Pervious pavement is most susceptible to failure difficulties during construction, and therefore it is important that the construction be undertaken in such a way as to **prevent**:

- Compaction of underlying soil
- Contamination of stone subbase with sediment and fines
- Tracking of sediment onto pavement
- Drainage of sediment laden waters onto pervious surface or into constructed bed

Staging, construction practices, and erosion and sediment control must all be taken into consideration when using pervious pavements.

Studies have shown that pervious systems have been very effective in reducing contaminants such as total suspended solids, metals, and oil and grease. When designed, constructed, and maintained according to the following guidelines, pervious pavement with underlying infiltration systems can dramatically reduce both the rate and volume of runoff, recharge the groundwater, and improve water quality.

In northern climates, pervious pavements have less of a tendency to form black ice and often require less plowing. Winter maintenance is described on page 17. Pervious asphalt and concrete surfaces provide better traction for walking paths in rain or snow conditions.



**Variations**

**Pervious Bituminous Asphalt**

Early work on pervious asphalt pavement was conducted in the early 1970’s by the Franklin Institute in Philadelphia and consists of standard bituminous asphalt in which the fines have been screened and reduced, allowing water to pass through small voids. Pervious asphalt is placed directly on the stone subbase in a single 3 ½ inch lift that is lightly rolled to a finish depth of 2 ½ inches.

Because pervious asphalt is standard asphalt with reduced fines, it is similar in appearance to standard asphalt. Recent research in open-graded mixes for highway application has led to additional improvements in pervious asphalt through the use of additives and higher-grade binders. Pervious asphalt is suitable for use in any climate where standard asphalt is appropriate.



## Pervious Concrete

Pervious Portland Cement Concrete, or pervious concrete, was developed by the Florida Concrete Association and has seen the most widespread application in Florida and southern areas. Like pervious asphalt, pervious concrete is produced by substantially reducing the number of fines in the mix in order to establish voids for drainage. In northern and mid-Atlantic climates such as Pennsylvania, pervious concrete should always be underlain by a stone subbase designed for stormwater management and should never be placed directly onto a soil subbase.

While pervious asphalt is very similar in appearance to standard asphalt, pervious concrete has a coarser appearance than its conventional counterpart. Care must be taken during placement to avoid working the surface and creating an impervious layer. Pervious concrete has been proven to be an effective stormwater management BMP. Additional information pertaining to pervious concrete, including specifications, is available from the Florida Concrete Association and the National Ready Mix Association.





## Pervious Paver Blocks

Pervious Paver Blocks consist of interlocking units (often concrete) that provide some portion of surface area that may be filled with a pervious material such as gravel. These units are often very attractive and are especially well suited to plazas, patios, small parking areas, etc. A number of manufactured products are available, including (but not limited to):



- Turfstone; UNI Eco-stone; Checkerblock; EcoPaver

As products are always being developed, the designer is encouraged to evaluate the benefits of various products with respect to the specific application. Many paver products recommend compaction of the soil and do not include a drainage/storage area, and therefore, they do not provide optimal stormwater management benefits. A system with a compacted subgrade will not provide significant infiltration.

## Reinforced Turf and Gravel Filled Grids

Reinforced Turf consists of interlocking structural units that contain voids or areas for turf grass growth and are suitable for traffic loads and parking. Reinforced turf units may consist of concrete or plastic and are underlain by a stone and/or sand drainage system for stormwater management. There are also products available that provide a fully permeable surface through the use of plastic rings/grids filled with gravel.

Reinforced Turf applications are excellent for Fire Access Roads, overflow parking, occasional use parking (such as at religious facilities and athletic facilities). Reinforced turf is also an excellent application to reduce the required standard pavement width of paths and driveways that must occasionally provide for emergency vehicle access.

While both plastic and concrete units perform well for stormwater management and traffic needs, plastic units tend to provide better turf establishment and longevity, largely because the plastic will not absorb water and diminish soil moisture conditions. A number of products (e.g. Grasspave, Geoblock, GravelPave, Grassy Pave, Geoweb) are available and the designer is encouraged to evaluate and select a product suitable to the design in question.



## Applications

### Parking

### Walkways

#### Pervious Pavement Walkways

Pervious pavement has also been used in walkways and sidewalks. These installations typically consist of a shallow (8 in. minimum) aggregate trench that is sloped to follow the surface slope of the path. In the case of relatively mild surface slopes, the aggregate infiltration trench may be “terraced” into level reaches in order to maximize the infiltration capacity, at the expense of additional aggregate.

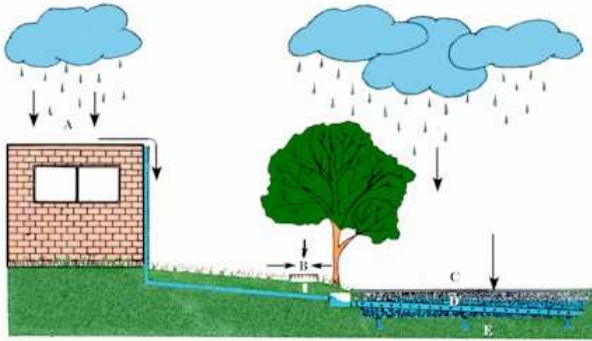


### Playgrounds



### Alleys

**Roof drainage; Direct connection of roof leaders and/or inlets**



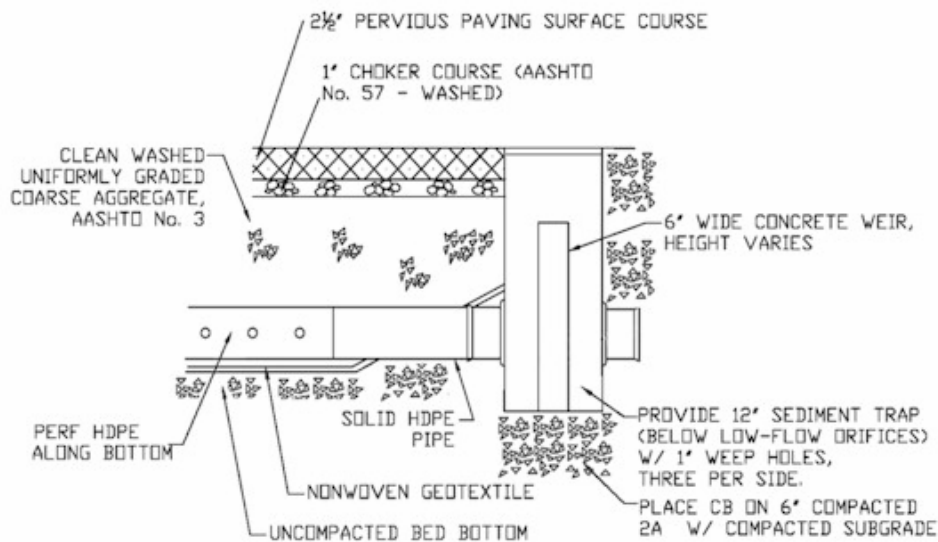
**Limited use for roads and highways**



**Design Considerations**

1. Protocol 1, Site Evaluation and Soil Infiltration Testing required (see Appendix C).
2. Protocol 2, Infiltration Systems Guidelines must be met (see Appendix C).
3. The overall site should be evaluated for potential pervious pavement / infiltration areas early in the design process, as effective pervious pavement design requires consideration of grading.
4. Orientation of the parking bays along the existing contours will significantly reduce the need for cut and fill.
5. Pervious pavement and infiltration beds **should not be placed on areas of recent fill** or compacted fill. Any grade adjust requiring fill should be done using the stone subbase material. Areas of historical fill (>5 years) may be considered for pervious pavement.

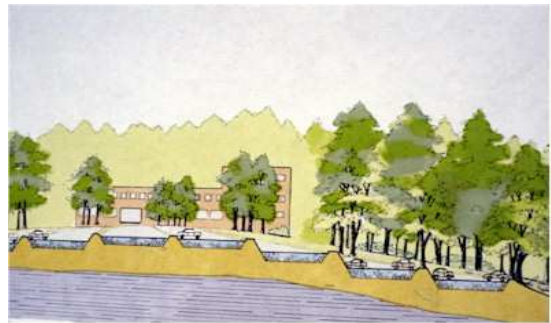
6. The bed bottom should not be compacted, however the stone subbase should be placed in lifts and lightly rolled according to the specifications.
7. During construction, the excavated bed may serve as a temporary sediment basin or trap. This will reduce overall site disturbance. The bed should be excavated to within twelve (12) inches of the final bed bottom elevation for use as a sediment trap or basin. Following construction and site stabilization, sediment should be removed and final grades established.
8. **Bed bottoms should be level or nearly level.** Sloping bed bottoms will lead to areas of ponding and reduced distribution.
9. **All systems should be designed with an overflow system.** Water within the subsurface stone bed should never rise to the level of the pavement surface. Inlet boxes can be used for cost-effective overflow structures. All beds should empty to meet the criteria in Chapter 3.
10. While infiltration beds are typically sized to handle the increased volume from a storm, they should also be able to convey and mitigate the peak of the less-frequent, more intense storms (such as the 100-yr). Control in the beds is usually provided in the form of an outlet control structure. A modified inlet box with an internal weir and low-flow orifice is a common type of control structure. The specific design of these structures may vary, depending on factors such as rate and storage requirements, but it always should include positive overflow from the system.
11. The subsurface bed and overflow may be designed and evaluated in the same manner as a detention basin to demonstrate the mitigation of peak flow rates. In this manner, the need for a detention basin may be eliminated or reduced in size.



12. A weir plate or weir within an inlet or overflow control structure may be used to maximize the water level in the stone bed while providing sufficient cover for overflow pipes.

- 13. Perforated pipes along the bottom of the bed may be used to evenly distribute runoff over the entire bed bottom. Continuously perforated pipes should connect structures (such as cleanouts and inlet boxes). Pipes should lay flat along the bed bottom and provide for uniform distribution of water. Depending on size, these pipes may provide additional storage volume.
- 14. Roof leaders and area inlets may be connected to convey runoff water to the bed. Water Quality Inserts or Sump Inlets should be used to prevent the conveyance of sediment and debris into the bed.
- 15. Infiltration areas should be located within the immediate project area in order to control runoff at its source. Expected use and traffic demands should also be considered in pervious pavement placement.
- 16. Control of sediment is critical. Rigorous installation and maintenance of erosion and sediment control measures should be provided to prevent sediment deposition on the pavement surface or within the stone bed. Nonwoven geotextile may be folded over the edge of the pavement until the site is stabilized. The Designer should consider the placement of pervious pavement to reduce the likelihood of sediment deposition. Surface sediment should be removed by a vacuum sweeper and should not be power-washed into the bed.

- 17. Infiltration beds may be placed on a slope by benching or terracing parking bays. Orienting parking bays along existing contours will reduce site disturbance and cut/fill requirements.



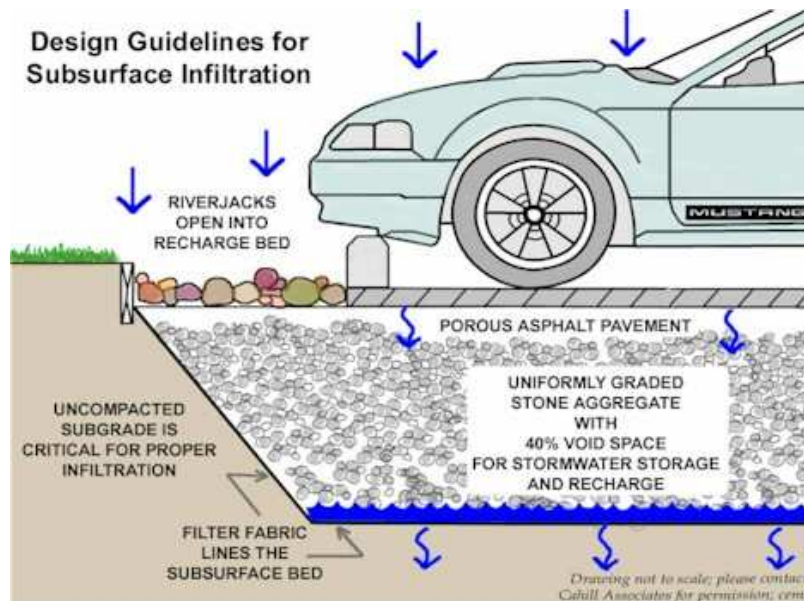
- 18. The underlying infiltration bed is typically 12-36 inches deep and comprised of clean, uniformly graded aggregate with approximately 40% void space. AASHTO No.3, which ranges 1.5-2.5 inches in gradation, is often used. Depending on local aggregate availability, both larger and smaller size aggregate has been used. The critical requirements are that the aggregate be uniformly graded, clean washed, and contain a significant void content. The depth of the bed is a function of stormwater storage requirements, frost depth considerations, site grading, and anticipated loading. Infiltration beds are typically sized to mitigate the increased runoff volume from a 2-yr design storm.

- 19. Most pervious pavement installations are underlain by an aggregate bed; alternative subsurface storage products may also be employed. These include a variety of proprietary, interlocking plastic units that contain much greater storage capacity than aggregate, at an increased cost.

- 20. All pervious pavement installations should have a backup method for water to enter the stone storage bed in the event that the pavement fails or is altered. In uncurbed lots, this backup drainage may consist of an unpaved 2 ft wide stone edge drain connected directly to the bed. In curbed lots, inlets with water quality devices may be required at low spots. Backup drainage elements will ensure the functionality of the infiltration system, if the pervious pavement is compromised.



21. In areas with poorly draining soils, infiltration beds below pervious pavement may be designed to slowly discharge to adjacent wetlands or bioretention areas. Only in extreme cases (i.e. industrial sites with contaminated soils) will the aggregate bed need to be lined to prevent infiltration.
22. In those areas where the threat of spills and groundwater contamination is likely, pretreatment systems, such as filters and wetlands, may be required before any infiltration occurs. In hot spot areas, such as truck stops, and fueling stations, the appropriateness of pervious pavement must be carefully considered. A stone infiltration bed located beneath standard pavement, preceded by spill control and water quality treatment, may be more appropriate.
23. The use of pervious pavement must be carefully considered in areas where the pavement may be seal coated or paved over due to lack of awareness, such as individual home driveways. In those situations, a system that is not easily altered by the property owner may be more appropriate. An example would include an infiltration system constructed under a conventional driveway. Educational signage at pervious pavement installations may guarantee its prolonged use in some areas.



## Detailed Stormwater Functions

### Volume Reduction Calculations

$$\text{Volume} = \text{Depth}^* (\text{ft}) \times \text{Area} (\text{sf}) \times \text{Void Space}$$

\*Depth is the depth of the water stored during a storm event, depending on the drainage area and conveyance to the bed.

$$\text{Infiltration Volume} = \text{Bed Bottom Area} (\text{sf}) \times \text{Infiltration design rate} (\text{in/hr}) \times \text{Infiltration period}^* (\text{hr}) \times (1/12)$$

\*Infiltration Period is the time when bed is receiving runoff and capable of infiltrating at the design rate. Not to exceed 72 hours.

**Peak Rate Mitigation**

See in Chapter 8 for Peak Rate Mitigation methodology that addresses link between volume reduction and peak rate control.

**Water Quality Improvement**

See in Chapter 8 for Water Quality methodology that addresses pollutant removal effectiveness of this BMP.

**Construction Sequence**

1. Due to the nature of construction sites, pervious pavement and other infiltration measures should be installed toward the end of the construction period, if possible. Infiltration beds under pervious pavement may be used as temporary sediment basins or traps provided that they are not excavated to within 12 inches of the designated bed bottom elevation. Once the site is stabilized and sediment storage is no longer required, the bed is excavated to its final grade and the pervious pavement system is installed.
2. The existing subgrade under the bed areas should NOT be compacted or subject to excessive construction equipment traffic prior to geotextile and stone bed placement.
3. Where erosion of subgrade has caused accumulation of fine materials and/or surface ponding, this material shall be removed with light equipment and the underlying soils scarified to a minimum depth of 6 inches with a York rake (or equivalent) and light tractor. All fine grading shall be done by hand. All bed bottoms should be at a level grade.
4. Earthen berms (if used) between infiltration beds should be left in place during excavation. These berms do not require compaction if proven stable during construction.
5. Geotextile and bed aggregate should be placed immediately after approval of subgrade preparation. Geotextile should be placed in accordance with manufacturer’s standards and recommendations. Adjacent strips of geotextile should overlap a minimum of 16 in. It should also be secured at least 4 ft. outside of bed in order to prevent any runoff or sediment from entering the storage bed. This edge strip should remain in place until all bare soils contiguous to beds are stabilized and vegetated. As the site is fully stabilized, excess geotextile along bed edges can be cut back to bed edge.
6. Clean (washed) uniformly graded aggregate is placed in the bed in 8-inch lifts. Each layer should be lightly compacted, with the construction equipment kept off the bed bottom as much as possible. Once bed aggregate is installed to the desired grade, a +/- 1 in. layer of choker base course (AASHTO #57) aggregate should be installed uniformly over the surface in order to provide an even surface for paving.





7. The pervious pavement should be installed in accordance with current standards. Further information can be obtained from the appropriate Association.

The full permeability of the pavement surface should be tested by application of clean water at the rate of at least 5 gpm over the surface, using a hose or other distribution device. All applied water should infiltrate directly without puddle formation or surface runoff.



## Maintenance Issues

The primary goal of pervious pavement maintenance is to prevent the pavement surface and/or underlying infiltration bed from being clogged with fine sediments. To keep the system clean throughout the year and prolong its life span, the pavement surface should be vacuumed biannually with a commercial cleaning unit. **Pavement washing systems or compressed air units are not recommended.** All inlet structures within or draining to the infiltration beds should also be cleaned out biannually.

Planted areas adjacent to pervious pavement should be well maintained to prevent soil washout onto the pavement. If any washout does occur it should be cleaned off the pavement immediately to prevent further clogging of the pores. Furthermore, if any bare spots or eroded areas are observed within the planted areas, they should be replanted and/or stabilized at once. Planted areas should be inspected on a semiannual basis. All trash and other litter that is observed during these inspections should be removed.

Superficial dirt does not necessarily clog the pavement voids. However, dirt that is ground in repeatedly by tires can lead to clogging. Therefore, trucks or other heavy vehicles should be prevented from tracking or spilling dirt onto the pavement. Furthermore, all construction or hazardous materials carriers should be prohibited from entering a pervious pavement lot.

### Special Maintenance Considerations:

- Prevent Clogging of Pavement Surface with Sediment
  - Vacuum pavement 2 or 3 times per year
  - Maintain planted areas adjacent to pavement
  - Immediately clean any soil deposited on pavement
  - Do not allow construction staging, soil/mulch storage, etc. on unprotected pavement surface
  - Clean inlets draining to the subsurface bed twice per year

### Winter Maintenance

Winter maintenance for a pervious parking lot may be necessary but is usually less intensive than that required for a standard impervious surface. By its very nature, a pervious pavement system with subsurface aggregate bed has superior snow melting characteristics than standard pavement. The underlying stone bed tends to absorb and retain heat so that freezing rain and snow melt faster on pervious pavement. Therefore, ice and light snow accumulation are generally not as problematic. However, snow will accumulate during heavier storms. Abrasives such as sand or cinders should not be applied on or adjacent to the pervious pavement. Snow plowing is fine, provided it is done carefully (i.e. by setting the blade slightly higher than usual, about an inch). Salt is acceptable for use as a deicer on the pervious pavement, though nontoxic, organic deicers, applied either as blended, magnesium chloride-based liquid products or as pretreated salt, are preferable.

### Repairs

Potholes in the pervious pavement are unlikely; though settling might occur if a soft spot in the subgrade is not removed during construction. For damaged areas of less than 50 square feet, a declivity could be patched by any means suitable with standard pavement, with the loss of porosity of that area being insignificant. The declivity can also be filled with pervious mix. If an

area greater than 50 sq. ft. is in need of repair, approval of patch type should be sought from either the engineer or owner. Under no circumstance should the pavement surface ever be seal coated. Any required repair of drainage structures should be done promptly to ensure continued proper functioning of the system.

**Cost Issues**

- Pervious asphalt, with additives, is generally 10% to 20% higher (2005) in cost than standard asphalt on a unit area basis.
- Pervious concrete as a material is generally more expensive than asphalt and requires more labor and experience for installation due to specific material constraints.
- Permeable interlocking concrete pavement blocks vary in cost depending on type and manufacturer.

The added cost of a pervious pavement/infiltration system lies in the underlying stone bed, which is generally deeper than a conventional subbase and wrapped in geotextile. However, this additional cost is often offset by the significant reduction in the required number of inlets and pipes. Also, since pervious pavement areas are often incorporated into the natural topography of a site, there generally is less earthwork and/or deep excavations involved. Furthermore, pervious pavement areas with subsurface infiltration beds often eliminate the need (and associated costs, space, etc.) for detention basins. When all of these factors are considered, pervious pavement with infiltration has proven itself less expensive than the impervious pavement with associated stormwater management. Recent (2005) installations have averaged between \$2000 and \$2500 per parking space, for the pavement and stormwater management.

**Specifications**

The following specifications are provided for informational purposes only. These specifications include information on acceptable materials for typical applications, but are by no means exclusive or limiting. The designer is responsible for developing detailed specifications for individual design projects in accordance with the project conditions.

1. **Stone** for infiltration beds shall be 2-inch to 1-inch uniformly graded coarse aggregate, with a wash loss of no more than 0.5%, AASHTO size number 3 per AASHTO Specifications, Part I, 19th Ed., 1998, or later and shall have voids 40% as measured by ASTM-C29. Choker base course aggregate for beds shall be 3/8 inch to 3/4 inch uniformly graded coarse aggregate AASHTO size number 57 per Table 4, AASHTO Specifications, Part I, 13th Ed., 1998 (p. 47).
2. **Non-Woven Geotextile** shall consist of needled nonwoven polypropylene fibers and meet the following properties:
  - a. Grab Tensile Strength (ASTM-D4632) ≥ 120 lbs
  - b. Mullen Burst Strength (ASTM-D3786) ≥ 225 psi
  - c. Flow Rate (ASTM-D4491) ≥ 95 gal/min/ft<sup>2</sup>
  - d. UV Resistance after 500 hrs (ASTM-D4355) ≥ 70%
  - e. Heat-set or heat-calendared fabrics are not permitted.

Acceptable types include Mirafi 140N, Amoco 4547, Geotex 451, or approved others.

- 3. **Pipe** shall be continuously perforated, smooth interior, with a minimum inside diameter of 6-inches. High-density polyethylene (HDPE) pipe shall meet AASHTO M252, Type S or AASHTO M294, Type S.

4. **Storm Drain Inlets and Structures**

- a. Concrete Construction: Concrete construction shall be in accordance with PennDOT Pub. 4082003 including current supplements or latest edition.
- b. Precast concrete inlets and manholes: Precast concrete inlets may be substituted for cast-in-place structures and shall be constructed as specified for cast-in-place. Standard inlet boxes will be modified to provide minimum 12" sump storage and bottom leaching basins, open to gravel sumps in sub-grade, when situated in the recharge bed.
- c. All PVC Catch Basins/Cleanouts/Inline Drains shall have H-10 or H-20 rated grates, depending on their placement (H-20 if vehicular loading).
- d. Steel reinforcing bars over the top of the outlet structure shall conform to ASTM A615, grades 60 and 40.
- e. Permanent turf reinforcement matting shall be installed according to manufacturers' specifications.

5. **Pervious Bituminous Asphalt**

Bituminous surface course for **pervious paving** should be two and one-half (2.5) inches thick with a bituminous mix of 5.75% to 6% by weight dry aggregate. **In accordance with ASTM D6390, drain down of the binder shall be no greater than 0.3%.** If more absorptive aggregates, such as limestone, are used in the mix, then the amount of bitumen is to be based on the testing procedures outlined in the National Asphalt Pavement Association's Information Series 131 – "Pervious Asphalt Pavements" (2003) or PennDOT equivalent.

Use neat asphalt binder modified with an elastomeric polymer to produce a binder meeting the requirements of PG 76-22 as specified in AASHTO MP-1. The elastomer polymer shall be styrene-butadiene-styrene (SBS), or approved equal, applied at a rate of 3% by weight of the total binder. The composite materials shall be thoroughly blended at the asphalt refinery or terminal prior to being loaded into the transport vehicle. The polymer modified asphalt binder shall be heat and storage stable.

Aggregate shall be minimum 90% crushed material and have a gradation of:

U.S. Standard Sieve Size	Percent Passing
½ (12.5 mm)	100
3/8 (9.5 mm)	92-98
4 (4.75 mm)	34-40
8 (2.36 mm)	14-20
16 (1.18 mm)	7-13
30 (0.60 mm)	0-4
200 (0.075mm)	0-2

Add hydrated lime at a dosage rate of 1.0% by weight of the total dry aggregate to mixes containing granite. Hydrated lime shall meet the requirements of ASTM C 977. The additive must be able to prevent the separation of the asphalt binder from the aggregate and achieve a

required tensile strength ratio (TSR) of at least 80% on the asphalt mix when tested in accordance with AASHTO T 283. The asphaltic mix shall be tested for its resistance to stripping by water in accordance with ASTM D-1664. If the estimated coating area is not above 95 percent, anti-stripping agents shall be added to the asphalt.

Pervious pavement shall not be installed on wet surfaces or when the ambient air temperature is 50 degrees Fahrenheit or lower. The temperature of the bituminous mix shall be between 300 degrees Fahrenheit and 350 degrees Fahrenheit (based on the recommendations of the asphalt supplier).

## 6. Pervious Concrete

### **GENERAL**

Weather Limitations: Do not place Portland cement pervious pavement mixtures when the ambient temperature is 40 degrees Fahrenheit or lower or 90 degrees Fahrenheit or higher, unless otherwise permitted in writing by the Engineer.

Test Panels: Regardless of qualification, Contractor is to place, joint and cure at least two test panels, each to be a minimum of 225 sq. ft. at the required project thickness to demonstrate to the Engineer's satisfaction that in-place unit weights can be achieved and a satisfactory pavement can be installed at the site location.

Test panels may be placed at any of the specified Portland Cement pervious locations. Test panels shall be tested for thickness in accordance with ASTM C 42; void structure in accordance with ASTM C 138; and for core unit weight in accordance with ASTM C 140, paragraph 6.3.

Satisfactory performance of the test panels will be determined by:  
Compacted thickness no less than ¼" of specified thickness.

Void Structure: 15% minimum; 21% maximum. Unit weight plus or minus 5 pcf of the design unit weight.

If measured void structure falls below 15% or if measured thickness is greater than ¼" less than the specified thickness or if measured weight falls less than 5 pcf below unit weight, the test panel shall be removed at the contractor's expense and disposed of in an approved landfill.

If the test panel meets the above-mentioned requirements, it can be left in-place and included in the completed work.

## CONCRETE MIX DESIGN

Contractor shall furnish a proposed mix design with proportions of materials to the Engineer prior to commencement of work. The data shall include unit weights determined in accordance with ASTM C29 paragraph 11, jiggling procedure.

## MATERIALS

**Cement:** Portland Cement Type I or II conforming to ASTM C 150 or Portland Cement Type IP or IS conforming to ASTM C 595.

**Aggregate:** Use No 8 coarse aggregate (3/8 to No. 16) per ASTM C 33 or No. 89 coarse aggregate (3/8 to No. 50) per ASTM D 448. If other gradation of aggregate is to be used, submit data on proposed material to owner for approval.

**Air Entraining Agent:** Shall comply with ASTM C 260 and shall be used to improve resistance to freeze/thaw cycles.

**Admixtures:** The following admixtures shall be used:

Type D Water Reducing/Retarding – ASTM C 494.

A hydration stabilizer that also meets the requirements of ASTM C 494 Type B Retarding or Type D Water Reducing/Retarding admixtures. This stabilizer suspends cement hydration by forming a protective barrier around the cementitious particles, which delays the particles from achieving initial set.

**Water:** Potable shall be used.

### Proportions:

**Cement Content:** For pavements subjected to vehicular traffic loading, the total cementitious material shall not be less than 600 lbs. Per cy.

**Aggregate Content:** the volume of aggregate per cu. yd. shall be equal to 27 cu.ft. when calculated as a function of the unit weight determined in accordance with ASTM C 29 jiggling procedure. Fine aggregate, if used, should not exceed 3 cu. ft. and shall be included in the total aggregate volume.

**Admixtures:** Shall be used in accordance with the manufacturer's instructions and recommendations.

**Mix Water:** Mix water shall be such that the cement paste displays a wet metallic sheen without causing the paste to flow from the aggregate. (Mix water yielding a cement paste with a dull-dry appearance has insufficient water for hydration).

- Insufficient water results in inconsistency in the mix and poor bond strength.
- High water content results in the paste sealing the void system primarily at the bottom and poor surface bond.

**An aggregate/cement (A/C) ratio range of 4:1 to 4.5:1 and a water/cement (W/C) ratio range of 0.34 to 0.40 should produce pervious pavement of satisfactory properties in regard to permeability, load carrying capacity, and durability characteristics.**

## INSTALLATION

**Portland Cement Pervious Pavement Concrete Mixing, Hauling and Placing:**

**Mix Time:** Truck mixers shall be operated at the speed designated as mixing speed by the manufacturer for 75 to 100 revolutions of the drum.

Transportation: The Portland Cement aggregate mixture may be transported or mixed on site and should be used within one (1) hour of the introduction of mix water, unless otherwise approved by an engineer. This time can be increased to 90 minutes when utilizing the specified hydration stabilizer. Each truck should not haul more than two (2) loads before being cycled to another type concrete. Prior to placing concrete, the subbase shall be moistened and in a wet condition. Failure to provide a moist subbase will result in a reduction in strength of the pavement.

Discharge: Each mixer truck will be inspected for appearance of concrete uniformity according to this specification. Water may be added to obtain the required mix consistency. A minimum of 20 revolutions at the manufacturer's designated mixing speed shall be required following any addition of water to the mix. Discharge shall be a continuous operation and shall be completed as quickly as possible. Concrete shall be deposited as close to its final position as practicable and such that fresh concrete enters the mass of previously placed concrete. The practice of discharging onto subgrade and pulling or shoveling to final placement is not allowed.

Placing and Finishing Equipment: Unless otherwise approved by the Owner or Engineer in writing, the Contractor shall provide mechanical equipment of either slipform or form riding with a following compactive unit that will provide a minimum of 10 psi vertical force. The pervious concrete pavement will be placed to the required cross section and shall not deviate more than +/- 3/8 inch in 10 feet from profile grade. If placing equipment does not provide the minimum specified vertical force, a full width roller or other full width compaction device that provides sufficient compactive effort shall be used immediately following the strike-off operation. After mechanical or other approved strike-off and compaction operation, no other finishing operation will be allowed. If vibration, internal or surface applied, is used, it shall be shut off immediately when forward progress is halted for any reason. The Contractor will be restricted to pavement placement widths of a maximum of fifteen (15') feet unless the Contractor can demonstrate competence to provide pavement placement widths greater than that to the satisfaction of the Engineer.

Curing: Curing procedures shall begin within 20 minutes after the final placement operations. The pavement surface shall be covered with a minimum six-(6) mil thick polyethylene sheet or other approved covering material. Prior to covering, a fog or light mist shall be sprayed above the surface when required due to ambient conditions (high temperature, high wind, and low humidity). The cover shall overlap all exposed edges and shall be secured (without using dirt) to prevent dislocation due to winds or adjacent traffic conditions.

Cure Time:

1. Portland Cement Type I, II, or IS – 7 days minimum.
2. No truck traffic shall be allowed for 10 days (no passenger car/light trucks for 7 days).

Jointing: Control (contraction) joints shall be installed at 20-foot intervals. They shall be installed at a depth of the 1/ 4 the thickness of the pavement. These joints can be installed in the plastic concrete or saw cut. If saw cut, the procedure should begin as soon as the pavement has hardened sufficiently to prevent raveling and uncontrolled cracking (normally after curing). Transverse construction joints shall be installed whenever placing is suspended a sufficient length of time that concrete may begin to harden. In order to assure aggregate bond at construction joints, a bonding agent suitable for bonding fresh concrete shall be brushed, trolled, or sprayed on the existing pavement surface edge. Isolation (expansion) joints will not be used except when pavement is abutting slabs or other adjoining structures.

## TESTING, INSPECTION, AND ACCEPTANCE

### Laboratory Testing:

The owner will retain an independent testing laboratory. The testing laboratory shall conform to the applicable requirements of ASTM E 329 "Standard Recommended Practice for Inspection and Testing Agencies for Concrete, Steel, and Bituminous Materials as Used in Construction" and ASTM C 1077 "Standard Practice for Testing Concrete and Concrete Aggregates for use in Construction, and Criteria for Laboratory Evaluation" and shall be inspected and accredited by the Construction Materials Engineering Council, Inc. or by an equivalent recognized national authority.

The Agent of the testing laboratory performing field sampling and testing of concrete shall be certified by the American Concrete Institute as a Concrete Field Testing Technician Grade I, or by a recognized state or national authority for an equivalent level of competence.

### Testing and Acceptance:

A minimum of 1 gradation test of the subgrade is required every 5000 square feet to determine percent passing the No. 200 sieve per ASTM C 117.

A minimum of one test for each day's placement of pervious concrete in accordance with ASTM C 172 and ASTM C 29 to verify unit weight shall be conducted. Delivered unit weights are to be determined in accordance with ASTM C 29 using a 0.25 cubic foot cylindrical metal measure. The measure is to be filled and compacted in accordance with ASTM C 29 paragraph 11, jiggling procedure. The unit weight of the delivered concrete shall be +/- 5 pcf of the design unit weight.

Test panels shall have two cores taken from each panel in accordance with ASTM 42 at a minimum of seven (7) days after placement of the pervious concrete. The cores shall be measured for thickness, void structure, and unit weight. Untrimmed, hardened core samples shall be used to determine placement thickness. The average of all production cores shall not be less than the specified thickness with no individual core being more than ½ inch less than the specified thickness. After thickness determination, the cores shall be trimmed and measured for unit weight in the saturated condition as described in paragraph 6.3.1 of 'Saturation' of ASTM C 140 "Standard Methods of Sampling and Testing Concrete Masonry Units." The trimmed cores shall be immersed in water for 24 hours, allowed to drain for one (1) minute, surface water removed with a damp cloth, then weighed immediately. Range of satisfactory unit weight values are +/- 5 pcf of the design unit weight.

After a minimum of 7 days following each placement, three cores shall be taken in accordance with ASTM C 42. The cores shall be measured for thickness and unit weight determined as described above for test panels. Core holes shall be filled with concrete meeting the pervious mix design.

## References and Additional Sources

Adams, Michele (2003). Porous Asphalt Pavement with Recharge Beds: 20 Years & Still Working, *Stormwater 4*, 24-32.

Backstrom, Magnus (1999). *Porous Pavement in a Cold Climate*, Licentiate Thesis, Lulea, Sweden: Lulea University of Technology (<http://epubl.luth.se>).

Cahill, Thomas (1993). *Porous Pavement with Underground Recharge Beds, Engineering Design Manual*, West Chester Pennsylvania: Cahill Associates.

Cahill, Thomas (1994). A Second Look at Porous Pavement/Underground Recharge, *Watershed Protection Techniques*, 1, 76-78.

Cahill, Thomas, Michele Adams, and Courtney Marm (2003). Porous Asphalt: The Right Choice for Porous Pavements, *Hot Mix Asphalt Technology* September-October.

Ferguson, Bruce (2005). *Porous Pavements*, Boca Raton, Florida: CRC Press.

Florida Concrete and Products Association (no date). *Construction of a Portland Cement Pervious Pavement*, Orlando: Florida Concrete and Products Association.

Hossain, Mustaque, Larry A. Scofield, and W.R. Meier, Jr. (1992). Porous Pavement for Control of Highway Runoff in Arizona: Performance to Date, *Transportation Research Record* 1354, 45-54.

Jackson, Newt (2003). *Porous Asphalt Pavements*, Information Series 131, Lanham, Maryland: National Asphalt Pavement Association.

Kandhal, Prithvi S. (2002). *Design, Construction, and Maintenance of Open-Graded Asphalt Friction Courses*, Information Series 115, Lanham, Maryland: National Asphalt Pavement Association.

Kandhal, Prithvi S., and Rajib B. Mallick (1998). *Open-Graded Asphalt Friction Course: State of the Practice*, Report No. 98-7, Auburn, Alabama: Auburn University National Center for Asphalt Technology.

Kandhal, Prithvi S., and Rajib B. Mallick (1999). *Design of New-Generation Open-Graded Friction Courses*, Report No. 99-2, Auburn, Alabama: Auburn University National Center for Asphalt Technology.

Mallick, Rajib B., Prithvi S. Kandhal, L. Allen Cooley Jr., and Donald E. Watson (2000). *Design, Construction and Performance of New-Generation Open-Graded Friction Courses*, Report No. 2000-01, Auburn, Alabama: Auburn University National Center for Asphalt Technology.

Paine, John E. (1990). *Stormwater Design Guide, Portland Cement Pervious Pavement*, Orlando: Florida Concrete and Products Association.

Smith, David R. (2001). *Permeable Interlocking Concrete Pavements: Selection, Design, Construction, Maintenance*, 2<sup>nd</sup> ed., Washington: Interlocking Concrete Pavement Institute.

Tappeiner, Walter J. (1993). *Open-Graded Asphalt Friction Course*, Information Series 115, Lanham, Maryland: National Asphalt Pavement Association.

Thelen, E. and Howe, L.F. (1978). *Porous Pavement*, Philadelphia: Franklin Institute Press.



## BMP 6.4.2: Infiltration Basin



An Infiltration Basin is a shallow impoundment that stores and infiltrates runoff over a level, uncompacted, (preferably undisturbed area) with relatively permeable soils.

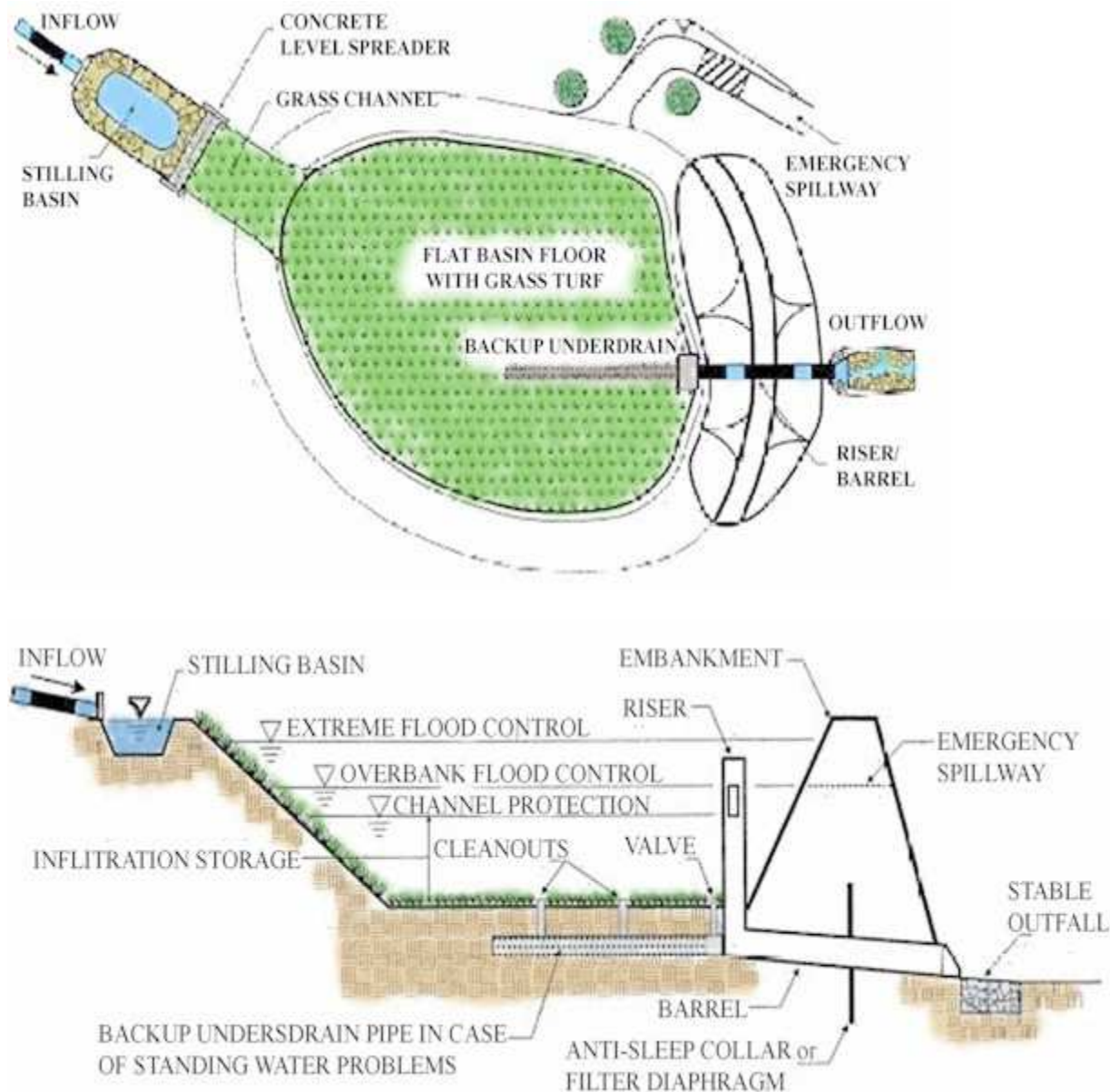
<p style="text-align: center;"><b><u>Key Design Elements</u></b></p> <ul style="list-style-type: none"> <li>▪ Maintain a minimum 2-foot separation to bedrock and seasonally high water table, provide distributed infiltration area (5:1 impervious area to infiltration area - maximum), site on natural, uncompacted soils with acceptable infiltration capacity, and follow other guidelines described in Protocol 2: Infiltration Systems Guidelines</li> <li>▪ Uncompacted sub-grade</li> <li>▪ Infiltration Guidelines and Soil Testing Protocols apply</li> <li>▪ Preserve existing vegetation, if possible</li> <li>▪ Design to hold/infiltrate volume difference in 2-yr storm or 1.5" storm</li> <li>▪ Provide positive stormwater overflow through engineered outlet structure.</li> <li>▪ Do not install on recently placed fill (&lt;5 years).</li> <li>▪ Allow 2 ft buffer between bed bottom and seasonal high groundwater table and 2 ft buffer for rock.</li> <li>▪ When possible, place on upland soils.</li> <li>▪</li> </ul>	<p style="text-align: center;"><b><u>Potential Applications</u></b></p> <p style="text-align: center;">Residential: Yes                  Commercial: Yes                  Ultra Urban: Limited                  Industrial: Yes*                  Retrofit: Yes                  Highway/Road: Limited</p> <p><small>* Applicable with specific consideration to design.</small></p> <hr/> <p style="text-align: center;"><b><u>Stormwater Functions</u></b></p> <p style="text-align: center;">Volume Reduction: High                  Recharge: High                  Peak Rate Control: Med./High                  Water Quality: High</p> <hr/> <p style="text-align: center;"><b><u>Water Quality Functions</u></b></p> <p style="text-align: center;">TSS: 85%                  TP: 85%                  NO3: 30%</p>
---	---

**Other Considerations**

- **Protocol 1. Site Evaluation and Soil Infiltration Testing** and **Protocol 2. Infiltration Systems Guidelines** should be followed, see Appendix C

### Description

Infiltration Basins are shallow, impounded areas designed to temporarily store and infiltrate stormwater runoff. The size and shape can vary from one large basin to multiple, smaller basins throughout a site. Ideally, the basin should avoid disturbance of existing vegetation. If disturbance is unavoidable, replanting and landscaping may be necessary and should integrate the existing landscape as subtly as possible and compaction of the soil must be prevented (see Infiltration Guidelines). Infiltration Basins use the existing soil mantle to reduce the volume of stormwater runoff by infiltration and evapotranspiration. The quality of the runoff is also improved by the natural cleansing processes of the existing soil mantle and also by the vegetation planted in the basins. The key to promoting infiltration is to provide enough surface area for the volume of runoff to be absorbed to meet the criteria in Chapter 3. An engineered overflow structure should be provided for the larger storms.



## Variations

- **Re-Vegetation**  
For existing unvegetated areas or for infiltration basins that require excavation, vegetation may be added. Planting in the infiltration area will improve water quality, encourage infiltration, and promote evapotranspiration. This vegetation may range from a meadow mix to more substantial woodland species. The planting plan should be sensitive to hydrologic variability anticipated in the basin, as well as to larger issues of native plants and habitat, aesthetics, and other planting objectives. **The use of turf grass is discouraged** due to soil compaction from the required frequent mowing and maintenance requirements.
- **Usable Surface**  
An Infiltration Basin can be used for recreation (usually informal) in dry periods. Heavy machinery and/or vehicular traffic of any type should be avoided so as not to compact the infiltration area.
- **Soils with Poor Infiltration Rates**  
A layer of sand (6") or gravel can be placed on the bottom of the Infiltration Basin, or the soil can be amended to increase the surface permeability of the basin. (See Soil Amendment & Restoration BMP 6.7.3 for details.)

## Applications

- **New Development**  
Infiltration Basins can be incorporated into new development. Ideally, existing vegetation can be preserved and utilized as the infiltration area. Runoff from adjacent buildings and impervious surfaces can be directed into this area, which will "water" the vegetation, thereby increasing evapotranspiration in addition to encouraging infiltration.
- **Retrofitting existing "lawns" and "open space"**  
Existing grassed areas can be converted to infiltration basins. If the soil and infiltration capacity is determined to be sufficient, the area can be enclosed through creation of a berm and runoff can be directed to it without excavation. Otherwise, excavation can be performed as described below.
- **Other Applications**  
Other applications of Infiltration Basins may be determined by the Design Professional as appropriate.

## Design Considerations

1. Soil Investigation and Infiltration Testing is required; site selection for this BMP should take soil and infiltration capacity into consideration.
2. Guidelines for Infiltration Systems should be met (i.e., depth to water table, setbacks, Loading Rates, etc.)
3. Basin designs that do not remove existing soil and/or vegetation are preferred.

4. The slope of the Infiltration Basin bottom should be level or with a slope no greater than 1%. A level bottom assures even water distribution and infiltration.
5. Basins may be constructed where impermeable soils on the surface are removed and where more permeable underlying soils then are used for the base of the bed; care must be taken in the excavation process to make sure that soil compaction does not occur.
6. The discharge or overflow from the Infiltration Basin should be properly designed for anticipated flows. Large infiltration basins may require multiple outlet control devices to effectively overflow water during the larger storms. See BMP 6.3.3 for more information on overflows and berms.
7. The berms surrounding the basin should be compacted earth with a slope of not steeper than 3:1(H:V), and a top width of at least 2 feet.
8. At least one foot of freeboard above the 100-year storm water elevation should be maintained.
9. Infiltration basins can be planted with natural grasses, meadow mix, or other “woody” mixes, such as trees or shrubs. These plants have longer roots than traditional grass and increase soil permeability. Native plants should be used wherever possible.
10. Use of fertilizer should be avoided.
11. The surface should be compacted as little as possible to allow for surface percolation through the soil layer.
12. When directing runoff from roadway areas into the basin, measures to reduce sediment should be used.
13. The inlets into the basin should have erosion protection.
14. Contributing inlets (up gradient) may have a sediment trap or water quality insert to prevent large particles from clogging the system based on the quality of the runoff.
15. Use of a backup underdrain or low-flow orifice may be considered in the event that the water in the basin does not drain within the criteria in Chapter 3. This underdrain valve should remain in the shut position unless the basin does not drain.

## Detailed Stormwater Functions

### Infiltration Area

The loading rate guidelines in Appendix C should be consulted  
The Infiltration Area is the bottom area of the bed.

### Volume Reduction Calculations

$$\text{Volume} = \text{Depth}^* (\text{ft}) \times \text{Area} (\text{sf})$$

\*Depth is the depth of the water stored during a storm event, depending on the drainage area and conveyance to the bed.

$$\text{Infiltration Volume} = \text{Bed Bottom Area} (\text{sf}) \times \text{Infiltration design rate} (\text{in/hr}) \\ \times \text{Infiltration period}^* (\text{hr}) \times (1/12)$$

\*Infiltration Period is equal to 2 hours or the time of concentration, whichever is larger.

**Peak Rate Mitigation Calculations:** See Chapter 8 for Peak Rate Mitigation methodology which addresses link between volume reduction and peak rate control.

**Water Quality Improvement:** See Chapter 8 for Water Quality Improvement methodology, which addresses pollutant removal effectiveness of this BMP.

### Construction Sequence

1. Protect Infiltration basin area from compaction prior to installation.
2. If possible, install Infiltration basin during later phases of site construction to prevent sedimentation and/or damage from construction activity. After installation, prevent sediment-laden water from entering inlets and pipes.
3. Install and maintain proper Erosion and Sediment Control Measures during construction.
4. If necessary, excavate Infiltration basin bottom to an uncompacted subgrade free from rocks and debris. Do NOT compact subgrade.
5. Install Outlet Control Structures.
6. Seed and stabilize topsoil. (Vegetate if appropriate with native plantings.)
7. Do not remove Inlet Protection or other Erosion and Sediment Control measures until site is fully stabilized.

### Maintenance and Inspection Issues

- Catch Basins and Inlets (upgradient of infiltration basin) should be inspected and cleaned at least two times per year and after runoff events.
- The vegetation along the surface of the Infiltration basin should be maintained in good condition, and any bare spots revegetated as soon as possible.
- Vehicles should not be parked or driven on an Infiltration Basin, and care should be taken to avoid excessive compaction by mowers.
- Inspect the basin after runoff events and make sure that runoff drains down within 72 hours. Mosquito's should not be a problem if the water drains in 72 hours. Mosquitoes require a

considerably long breeding period with relatively static water levels.

- Also inspect for accumulation of sediment, damage to outlet control structures, erosion control measures, signs of water contamination/spills, and slope stability in the berms.
- Mow only as appropriate for vegetative cover species.
- Remove accumulated sediment from basin as required. Restore original cross section and infiltration rate. Properly dispose of sediment.

### Cost Issues

The construction cost of Infiltration Basins can vary greatly depending on the configuration, location, site-specific conditions, etc.

Excavation (if necessary) - varies

Plantings - Meadow mix \$2500 - \$3500 / acre (2005)

Pipe Configuration – varies with stormwater configuration, may need to redirect pipes into the infiltration basin.

### Specifications

The following specifications are provided for information purposes only. These specifications include information on acceptable materials for typical applications, but are by no means exclusive or limiting. The designer is responsible for developing detailed specifications for individual design projects in accordance with the project conditions.

1. **Topsoil** amend with compost if necessary or desired. (See Soil Amendment & Restoration BMP 6.7.2)

2. **Vegetation** See Native Plant List available locally, and/or see Appendix B.

### References

Michigan Department of Environmental Quality. *Index of Individual BMPs*. 2004. State of Michigan. <  
[http://www.michigan.gov/deq/1,1607,7-135-3313\\_3682\\_3714-13186—,00.html](http://www.michigan.gov/deq/1,1607,7-135-3313_3682_3714-13186—,00.html)>

Young, et. al., "Evaluation and Management of Highway Runoff Water Quality," Federal Highway Administration, 1996

California Stormwater Quality Association. *California Stormwater Best Management Practices Handbook: New Development and Redevelopment*. 2003.

Metropolitan Council Environmental Services. *Minnesota Urban Small Sites BMP Manual*. 2001.

New Jersey Department of Environmental Protection. *New Jersey Stormwater Best Management Practices Manual*. 2004.

## BMP 6.4.3: Subsurface Infiltration Bed



Subsurface Infiltration Beds provide temporary storage and infiltration of stormwater runoff by placing storage media of varying types beneath the proposed surface grade. Vegetation will help to increase the amount of evapotranspiration taking place.

<p style="text-align: center;"><b><u>Key Design Elements</u></b></p> <ul style="list-style-type: none"> <li>▪ Maintain a minimum 2-foot separation to bedrock and seasonally high water table, provide distributed infiltration area (5:1 impervious area to infiltration area - maximum), site on natural, uncompacted soils with acceptable infiltration capacity, and follow other guidelines described in Protocol 2: Infiltration Systems Guidelines</li> <li>▪ Beds filled with stone (or alternative) as needed to increase void space</li> <li>▪ Wrapped in nonwoven geotextile</li> <li>▪ Level or nearly level bed bottoms</li> <li>▪ Provide positive stormwater overflow from beds</li> <li>▪ Protect from sedimentation during construction</li> <li>▪ Provide perforated pipe network along bed bottom for distribution as necessary</li> <li>▪ Open-graded, clean stone with minimum 40% void space</li> <li>▪ Do not place bed bottom on compacted fill</li> <li>• Allow 2 ft. buffer between bed bottom and seasonal high groundwater table and 2 ft. for bedrock.</li> </ul>	<p style="text-align: center;"><b><u>Potential Applications</u></b></p> <p style="text-align: center;">Residential: Yes                  Commercial: Yes                  Ultra Urban: Yes                  Industrial: Yes                  Retrofit: Yes                  Highway/Road: Limited</p>
	<p style="text-align: center;"><b><u>Stormwater Functions</u></b></p> <p style="text-align: center;">Volume Reduction: High                  Recharge: High                  Peak Rate Control: Med./High                  Water Quality: High</p>
	<p style="text-align: center;"><b><u>Water Quality Functions</u></b></p> <p style="text-align: center;">TSS: 85%                  TP: 85%                  NO3: 30%</p>

**Other Considerations**

- **Protocol 1. Site Evaluation and Soil Infiltration Testing** and **Protocol 2. Infiltration Systems Guidelines** should be followed, see Appendix C

## Description

A Subsurface Infiltration Bed generally consists of a vegetated, highly pervious soil media underlain by a uniformly graded aggregate (or alternative) bed for temporary storage and infiltration of stormwater runoff. Subsurface Infiltration beds are ideally suited for expansive, generally flat open spaces, such as lawns, meadows, and playfields, which are located downhill from nearby impervious areas. Subsurface Infiltration Beds can be stepped or terraced down sloping terrain provided that the base of the bed remains level. Stormwater runoff from nearby impervious areas (including rooftops, parking lots, roads, walkways, etc.) can be conveyed to the subsurface storage media, where it is then distributed via a network of perforated piping.

The storage media for subsurface infiltration beds typically consists of clean-washed, uniformly graded aggregate. However, other storage media alternatives are available. These alternatives are generally variations on plastic cells that can more than double the storage capacity of aggregate beds, at a substantially increased cost. Storage media alternatives are ideally suited for sites where potential infiltration area is limited.

If designed, constructed, and maintained as per the following guidelines, Subsurface Infiltration features can stand-alone as significant stormwater runoff volume, rate, and quality control practices. These systems can also maintain aquifer recharge, while preserving or creating valuable open space and recreation areas. They have the added benefit of functioning year-round, given that the infiltration surface is typically below the frost line.

## Variations

As its name suggests, Subsurface Infiltration is generally employed for temporary storage and infiltration of runoff in subsurface storage media. However, in some cases, runoff may be temporarily stored on the surface (to depths less than 6 inches) to enhance volume capacity of the system. The overall system design should ensure that within the criteria in Chapter 3, the bed is completely empty.

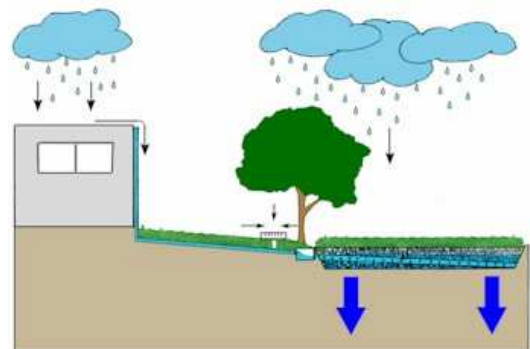
## Applications

### Connection of Roof Leaders

Runoff from nearby roofs may be directly conveyed to subsurface beds via roof leader connections to perforated piping. Roof runoff generally has relatively low sediment levels, making it ideally suited for connection to an infiltration bed. However, cleanout(s) with a sediment sump are still recommended between the building and infiltration bed.

### Connection of Inlets

Catch Basins, inlets, and area drains may be connected to Subsurface Infiltration beds. However, sediment and debris removal should be provided. Storm structures should therefore include sediment trap areas below the inverts of discharge pipes to trap solids and debris. In areas of high traffic or excessive generation of sediment, litter, and other similar materials, a water quality insert or other pretreatment device may be needed.





**Under Recreational Fields**

Subsurface Infiltration is very well suited below playfields and other recreational areas. Special consideration should be given to the engineered soil mix in those cases.

**Under Open Space**

Subsurface Infiltration is also appropriate in either existing or proposed open space areas. Ideally, these areas are vegetated with native grasses and/or vegetation to enhance site aesthetics and landscaping. Aside from occasional clean-outs or outlet structures, Subsurface Infiltration systems are essentially hidden stormwater management features, making them ideal for open space locations (deed-restricted open space locations are especially desirable because such locations minimize the chance that Subsurface Infiltration systems will be disturbed or disrupted accidentally in the future).



**Other Applications**

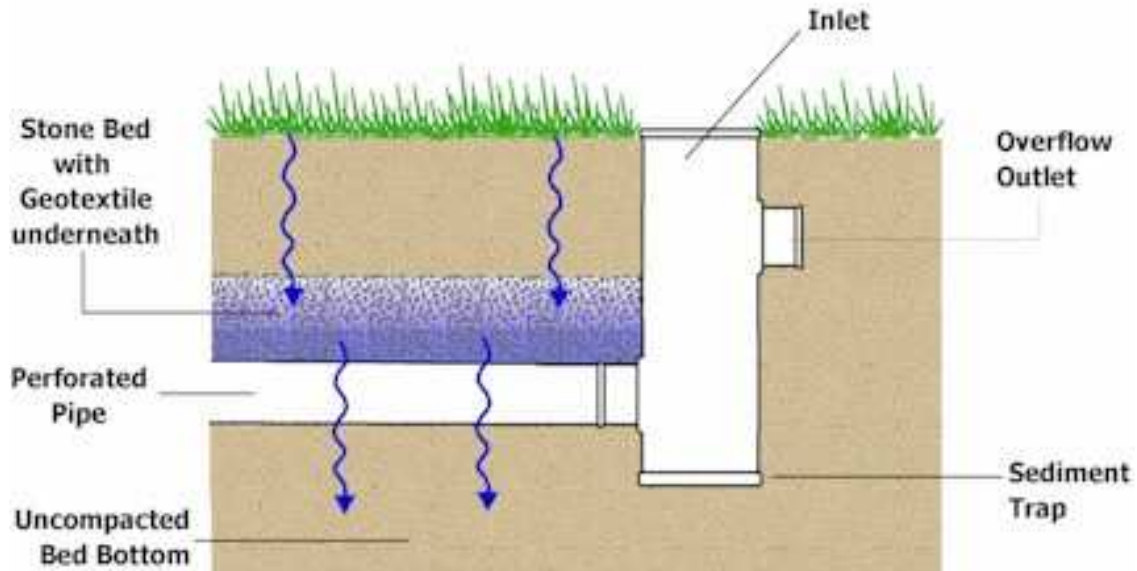
Other applications of Subsurface Infiltration beds may be determined by the Design Professional as appropriate.

**Design Considerations**

1. Soil Investigation and Infiltration Testing is needed (Appendix C).
2. Guidelines for Infiltration Systems should be met (Appendix C).
3. The overall site should be evaluated for potential Subsurface Infiltration areas early in the design process, as effective design requires consideration of existing site characteristics (topography, natural features/drainage ways, soils, geology, etc.).
4. Control of Sediment is critical. Rigorous installation and maintenance of erosion and sediment control measures is needed to prevent sediment deposition within the stone bed. Nonwoven geotextile may be folded over the edge of the bed until the site is stabilized.
5. The Infiltration bed should be wrapped in non-woven geotextile filter fabric.
6. Subsurface Infiltration areas should not be placed on areas of recent fill or compacted fill. Any grade adjustments requiring fill should be done using the stone subbase material, or alternative. Areas of historical fill (>5 years) may be considered if other criteria are met.



7. The subsurface infiltration bed is typically comprised of a 12 to 36 inch section of aggregate, such as AASHTO No.3, which ranges 1-2 inches in gradation. Depending on local aggregate availability, both larger and smaller size aggregate has been used. The critical requirements are that the aggregate be uniformly graded, clean-washed, and contain at least 40% void space. The depth of the bed is a function of stormwater storage requirements, frost depth considerations, and site grading. Infiltration beds are typically sized to mitigate the increased runoff volume from the design storm.



8. Water Quality Inlet or Catch Basin with Sump is needed for all surface inlets, should be designed to avoid standing water for periods greater than the criteria in Chapter 3.
9. Infiltration beds may be placed on a slope by benching or terracing infiltration levels. The slope of the infiltration bed bottom should be level or with a slope no greater than 1%. A level bottom assures even water distribution and infiltration.
10. Perforated pipes along the bottom of the bed can be used to evenly distribute runoff over the entire bed bottom. Continuously perforated pipes may connect structures (such as cleanouts and inlet boxes). Pipes should lay flat along the bed bottom and provide for uniform distribution of water. Depending on size, these pipes may provide additional storage volume.
11. Cleanouts or inlets should be installed at a few locations within the bed and at appropriate intervals to allow access to the perforated piping network and or storage media.
12. All infiltration beds should be designed with an overflow for extreme storm events. Control in the beds is usually provided in the form of an outlet control structure. A modified inlet box with an internal concrete weir (or weir plate) and low-flow orifice is a common type of control structure. The specific design of these structures may vary, depending on factors such as rate and storage requirements, but it must always include positive overflow from the system. The overflow structure is used to maximize the water level in the stone bed, while providing sufficient cover for overflow pipes. Generally, the top of the outlet pipe should be 4 inches below the top of the aggregate to prevent saturated soil conditions in remote areas of the bed. As with all

infiltration practices, multiple discharge points are recommended. These may discharge to the surface or a storm sewer system.

13. Adequate soil cover (generally 12 - 18 inches) should be maintained above the infiltration bed to allow for a healthy vegetative cover.
14. Open space overlying infiltration beds can be vegetated with native grasses, meadow mix, or other low-growing, dense vegetation. These plants have longer roots than traditional grass and will likely benefit from the moisture in the infiltration bed, improving the growth of these plantings and, potentially increasing evapotranspiration.
15. Fertilizer use should be minimized.
16. The surface (above the stone bed) should be compacted as minimally as possible to allow for surface percolation through the engineered soil layer and into the stone bed.
17. When directing runoff from roadway areas into the beds, measures to reduce sediment should be used.
18. Surface grading should be relatively flat, although a relatively mild slope between 1% and 3% is recommended to facilitate drainage.
19. In those areas where the threat of spills and groundwater contamination exists, pretreatment systems, such as filters and wetlands, may be needed before any infiltration occurs. In Hot Spot areas, such as truck stops and fueling stations, the suitability of Subsurface Infiltration must be considered.
20. In areas with poorly-draining soils, Subsurface Infiltration areas may be designed to slowly discharge to adjacent wetlands or bioretention areas.
21. While most Subsurface Infiltration areas consist of an aggregate storage bed, alternative subsurface storage products may also be employed. These include a variety of proprietary, interlocking plastic units that contain much greater storage capacity than aggregate, at an increased cost.
22. The subsurface bed and overflow may be designed and evaluated in the same manner as a detention basin to demonstrate the mitigation of peak flow rates. In this manner, detention basins may be eliminated or significantly reduced in size.
23. During Construction, the excavated bed may serve as a Temporary Sediment Basin or Trap. This can reduce overall site disturbance. The bed should be excavated to at least 1 foot above the final bed bottom elevation for use as a sediment trap or basin. Following construction and site stabilization, sediment should be removed and final grades established. In BMPs that will be used for infiltration in the future, use of construction equipment should be limited as much as possible.

## Detailed Stormwater Functions

### Infiltration Area

Loading rate guidelines in Appendix C should be consulted.

The Infiltration Area is the bottom area of the bed, defined as:

Length of bed x Width of bed = Infiltration Area (if rectangular)

### Volume Reduction Calculations

Volume = Depth\* (ft) x Area (sf) x Void Space

\*Depth is the depth of water stored during a storm event, depending on the drainage area and conveyance to the bed.

Infiltration Volume = Bed Bottom Area (sf) x Infiltration design rate (in/hr)  
x Infiltration period\* (hr) x (1/12)

\*Infiltration Period is equal to 2 hours or the time of concentration, whichever is larger.

Additional storage/volume reduction can be calculated for the overlying soil as appropriate.

### Peak Rate Mitigation Calculations

See in Chapter 8 for Peak Rate Mitigation methodology which addresses link between volume reduction and peak rate control.

**Water Quality Improvement:** See in Chapter 8 for Water Quality Improvement methodology, which addresses pollutant removal effectiveness of this BMP.

### Construction Sequence

1. Due to the nature of construction sites, Subsurface Infiltration should be installed toward the end of the construction period, if possible. (Infiltration beds may be used as temporary sediment basins or traps as discussed above).
2. Install and maintain adequate Erosion and Sediment Control Measures (as per the Pennsylvania Erosion and Sedimentation Control Program Manual) during construction.
3. The existing subgrade under the bed areas should NOT be compacted or subject to excessive construction equipment traffic prior to geotextile and stone bed placement.
4. Where erosion of subgrade has caused accumulation of fine materials and/or surface ponding, this material should be removed with light equipment and the underlying soils scarified to a minimum depth of 6 inches with a York rake (or equivalent) and light tractor. All fine grading should be done by hand. All bed bottoms should be at level grade.
5. Earthen berms (if used) between infiltration beds should be left in place during excavation. These berms do not require compaction if proven stable during construction.

6. Install upstream and downstream control structures, cleanouts, perforated piping, and all other necessary stormwater structures.
7. Geotextile and bed aggregate should be placed immediately after approval of subgrade preparation and installation of structures. Geotextile should be placed in accordance with manufacturer's standards and recommendations. Adjacent strips of geotextile should overlap a minimum of 16 inches. It should also be secured at least 4 feet outside of bed in order to prevent any runoff or sediment from entering the storage bed. This edge strip should remain in place until all bare soils contiguous to beds are stabilized and vegetated. As the site is fully stabilized, excess geotextile along bed edges can be cut back to the edge of the bed.
8. Clean-washed, uniformly graded aggregate should be placed in the bed in maximum 8-inch lifts. Each layer should be lightly compacted, with construction equipment kept off the bed bottom as much as possible.
9. Approved soil media should be placed over infiltration bed in maximum 6-inch lifts.
10. Seed and stabilize topsoil.
11. Do not remove inlet protection or other Erosion and Sediment Control measures until site is fully stabilized.

## Maintenance Issues

Subsurface Infiltration is generally less maintenance intensive than other practices of its type. Generally speaking, vegetation associated with Subsurface Infiltration practices is less substantial than practices such as Recharge Gardens and Vegetated Swales and therefore requires less maintenance. Maintenance activities required for the subsurface bed are similar to those of any infiltration system and focus on regular sediment and debris removal. The following represents the recommended maintenance efforts:

- All Catch Basins and Inlets should be inspected and cleaned at least 2 times per year.
- The overlying vegetation of Subsurface Infiltration features should be maintained in good condition, and any bare spots revegetated as soon as possible.
- Vehicular access on Subsurface Infiltration areas should be prohibited, and care should be taken to avoid excessive compaction by mowers. If access is needed, use of permeable, turf reinforcement should be considered.

## Cost Issues

The construction cost of Subsurface Infiltration can vary greatly depending on design variations, configuration, location, desired storage volume, and site-specific conditions, among other factors. Typical construction costs are about \$5.70 per square foot, which includes excavation, aggregate (2.0 feet assumed), non-woven geotextile, pipes and plantings.

## Specifications

The following specifications are provided for information purposes only. These specifications include information on acceptable materials for typical applications, but are by no means exclusive or limiting. The designer is responsible for developing detailed specifications for individual design projects in accordance with the project conditions.

1. **Stone** for infiltration beds shall be 2-inch to 1-inch uniformly graded coarse aggregate, with a wash loss of no more than 0.5%, AASHTO size number 3 per AASHTO Specifications, Part I, 19th Ed., 1998, or later and shall have voids 40% as measured by ASTM-C29.
2. **Non-Woven Geotextile** shall consist of needled non-woven polypropylene fibers and meet the following properties:
 

a. Grab Tensile Strength (ASTM-D4632)	120 lbs
b. Mullen Burst Strength (ASTM-D3786)	225 psi
c. Flow Rate (ASTM-D4491)	95 gal/min/ft <sup>2</sup>
d. UV Resistance after 500 hrs (ASTM-D4355)	70%
e. Heat-set or heat-calendared fabrics are not permitted	
Acceptable types include Mirafi 140N, Amoco 4547, and Geotex 451.	
3. **Topsoil** may be amended with compost (See soil restoration BMP 6.7.2)
4. **Pipe** shall be continuously perforated, smooth interior, with a minimum inside diameter of 6-inches. High-density polyethylene (HDPE) pipe shall meet AASHTO M252, Type S or AASHTO M294, Type S.
5. **Storm Drain Inlets and Structures**
  - a. Concrete Construction: Concrete construction shall be in accordance with Section 1001, PennDOT Specifications, 1990 or latest edition.
  - b. Precast Concrete Inlets and Manholes: Precast concrete inlets may be substituted for cast-in-place structures and shall be constructed as specified for cast-in-place.

Precast structures may be used in only those areas where there is no conflict with existing underground structures that may necessitate revision of inverts. Type M standard PennDOT inlet boxes will be modified to provide minimum 12 inch sump storage and bottom leaching basins, open to gravel sumps in sub-grade, when situated in the recharge bed.

  - c. All PVC Catch Basins/Cleanouts/Inline Drains shall have H-10 or H-20 rated grates, depending on their placement (H-20 if vehicular loading).
  - d. Steel reinforcing bars over the top of the outlet structure shall conform to ASTM A615, grades 60 and 40.
  - e. Permanent turf reinforcement matting shall be installed according to manufacturers' specifications.
6. **Alternative storage media:** Follow appropriate Manufacturers' specifications.
7. **Vegetation** see Local Native Plant List and Appendix B.

## BMP 6.4.4: Infiltration Trench



An Infiltration Trench is a “leaky” pipe in a stone filled trench with a level bottom. An Infiltration Trench may be used as part of a larger storm sewer system, such as a relatively flat section of storm sewer, or it may serve as a portion of a stormwater system for a small area, such as a portion of a roof or a single catch basin. In all cases, an Infiltration Trench should be designed with a positive overflow.

<p style="text-align: center;"><b><u>Key Design Elements</u></b></p> <ul style="list-style-type: none"> <li>▪ Continuously perforated pipe set at a minimum slope in a stone filled, level-bottomed trench</li> <li>▪ Limited in width (3 to 8 feet) and depth of stone (6 feet max. recommended)</li> <li>▪ Trench is wrapped in nonwoven geotextile (top, sides, and bottom)</li> <li>▪ Placed on uncompacted soils</li> <li>▪ Minimum cover over pipe is as per manufacturer.</li> <li>▪ A minimum of 6" of topsoil is placed over trench and vegetated</li> <li>▪ Positive Overflow always provided Deed restrictions recommended Not for use in hot spot areas without pretreatment</li> </ul>	<p style="text-align: center;"><b><u>Potential Applications</u></b></p> <p>Residential: Yes Commercial: Yes Ultra Urban: Yes Industrial: Yes Retrofit: Yes Highway/Road: Yes</p> <hr/> <p style="text-align: center;"><b><u>Stormwater Functions</u></b></p> <p>Volume Reduction: Medium Recharge: High Peak Rate Control: Medium Water Quality: High</p> <hr/> <p style="text-align: center;"><b><u>Water Quality Functions</u></b></p> <p>TSS: 85% TP: 85% NO3: 30%</p>
---	---

### **Other Considerations**

- **Protocol 1. Site Evaluation and Soil Infiltration Testing** and **Protocol 2. Infiltration Systems Guidelines** should be followed, see Appendix C

### Description

An Infiltration Trench is a linear stormwater BMP consisting of a continuously perforated pipe at a minimum slope in a stone-filled trench (Figure 6.4-1). Usually an Infiltration Trench is part of a **conveyance system** and is designed so that large storm events are conveyed through the pipe with some runoff volume reduction. During small storm events, volume reduction may be significant and there may be little or no discharge. All Infiltration Trenches are designed with a **positive overflow** (Figure 6.4-2).

An Infiltration Trench differs from an Infiltration Bed in that it may be constructed without heavy equipment entering the trench. It is also intended to convey some portion of runoff in many storm events.

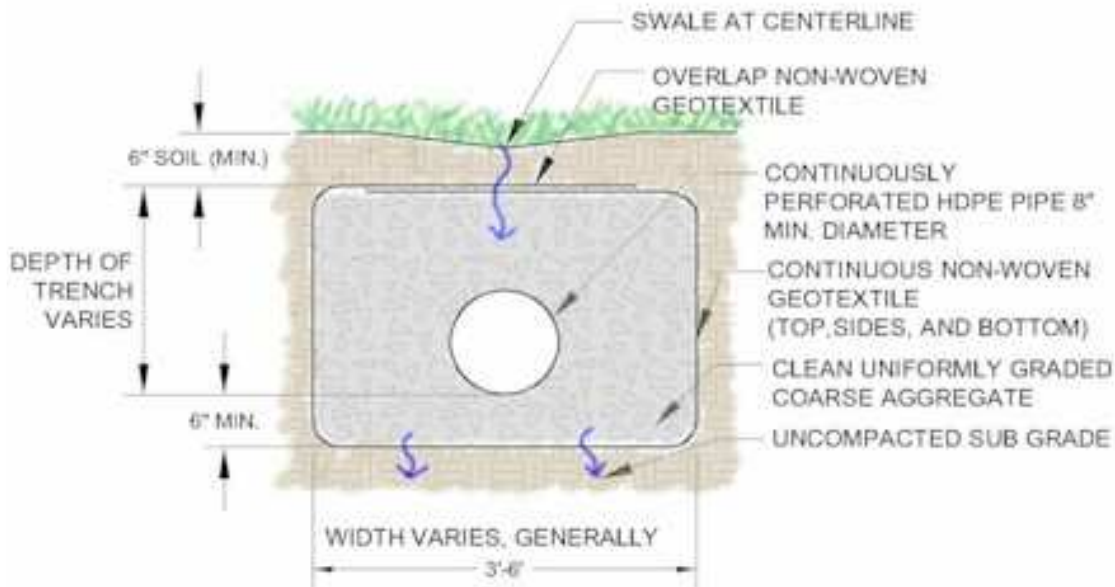


Figure 6.4-1

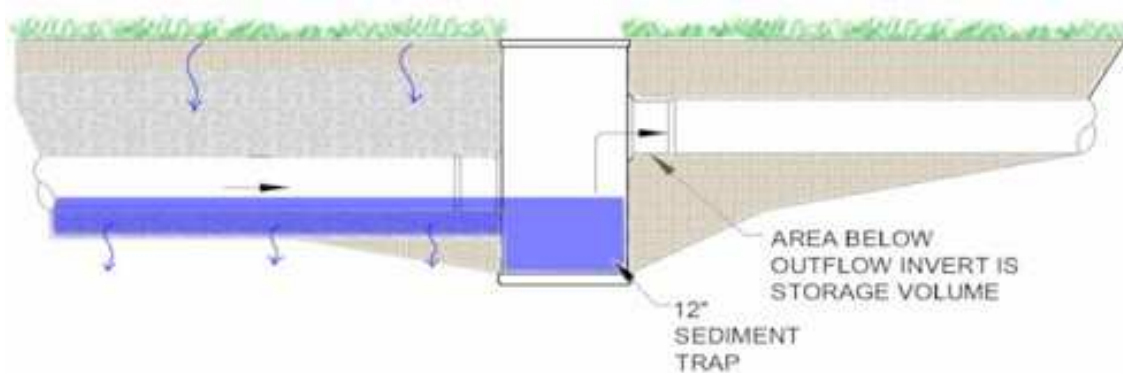


Figure 6.4-2

All Infiltration Trenches should be designed in accordance with Appendix C. Although the width and depth can vary, it is recommended that Infiltration Trenches be limited in depth to not more than six (6)



feet of stone. This is due to both construction issues and Loading Rate issues (as described in the Guidelines for Infiltration Systems). The designer should consider the appropriate depth.

**Variations**

Infiltration Trenches generally have a vegetated (grassed) or gravel surface. Infiltration Trenches also may be located alongside or adjacent to roadways or impervious paved areas with proper design. The subsurface drainage direction should be to the downhill side (away from subbase of pavement), or located lower than the impervious subbase layer. Proper measures should be taken to prevent water infiltrating into the subbase of impervious pavement.

Infiltration Trenches may also be located down a mild slope by “stepping” the sections between control structures as shown in Figure 6.4-3. A level or nearly level bottom is recommended for even distribution.

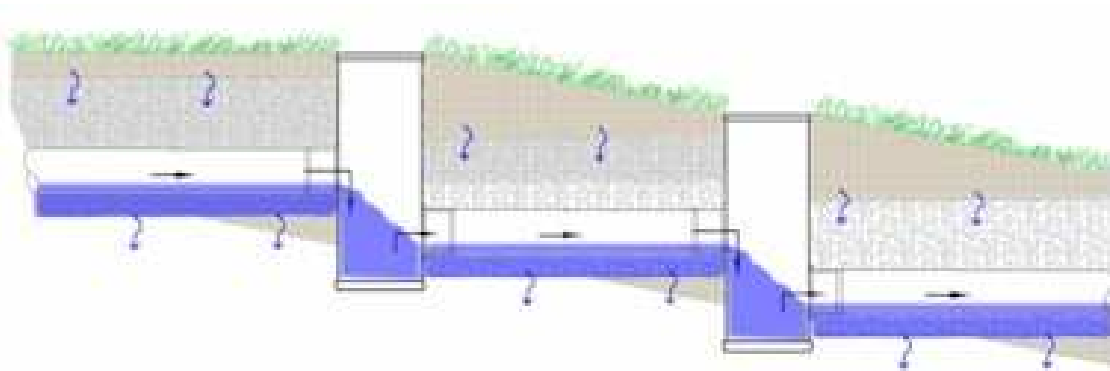


Figure 6.4-3

**Applications**

- **Connection of Roof Leaders**

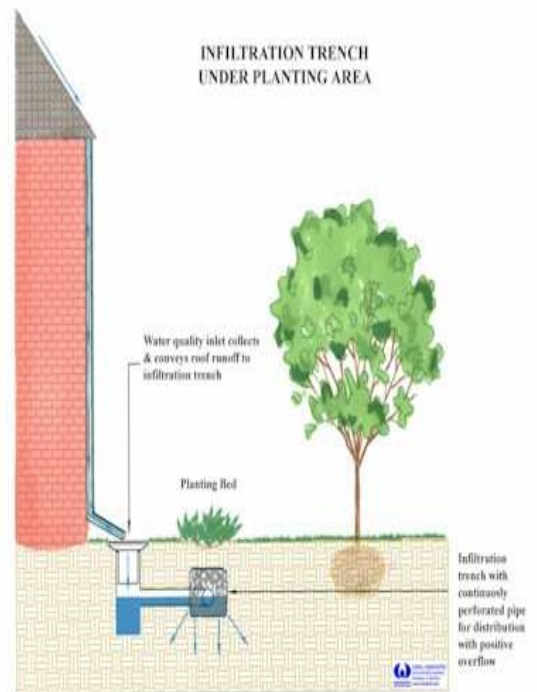
Roof leaders may be connected to Infiltration Trenches. Roof runoff generally has lower sediment levels and often is ideally suited for discharge through an Infiltration Trench. A cleanout with sediment sump should be provided between the building and Infiltration Trench.

- **Connection of Inlets**

Catch Basins, inlets and area drains may be connected to Infiltration Trenches, however sediment and debris removal should be addressed. Structures should include a sediment trap area below the invert of the pipe for solids and debris. In areas of high traffic or areas where excessive sediment, litter, and other similar materials may be generated, a water quality insert or other pretreatment device is needed.

- **In Combination with Vegetative Filters**

An Infiltration Trench may be preceded by or used in combination with a Vegetative Filter, Grassed Swale, or other vegetative element used to reduce sediment levels



from areas such as high traffic roadways. Design should ensure proper functioning of vegetative system.

- **Other Applications**

Other applications of Infiltration Trenches may be determined by the design professional as appropriate.

**Design Considerations**

1. Soil Investigation and Percolation Testing is required (see Appendix C, Protocol 2)
2. Guidelines for Infiltration Systems should be met (i.e., depth to water table, setbacks, Loading Rates, etc. See Appendix C, Protocol 1)
3. Water Quality Inlet or Catch Basin with Sump (see Section 6.6.4) recommended for all surface inlets, designed to avoid standing water for periods greater than the criteria in Chapter 3.
4. A continuously perforated pipe should extend the length of the trench and have a positive flow connection designed to allow high flows to be conveyed through the Infiltration Trench.
5. The slope of the Infiltration Trench bottom should be level or with a slope no greater than 1%. The Trench may be constructed as a series of “steps” if necessary. A level bottom assures even water distribution and infiltration.
6. Cleanouts or inlets should be installed at both ends of the Infiltration Trench and at appropriate intervals to allow access to the perforated pipe.
7. The discharge or overflow from the Infiltration Trench should be properly designed for anticipated flows.

**Detailed Stormwater Functions**

**Infiltration Area**

The Infiltration Area is the bottom area of the Trench\*, defined as:

$$\text{Length of Trench} \times \text{Width of Trench} = \text{Infiltration Area (Bottom Area)}$$

This is the area to be considered when evaluating the Loading Rate to the Infiltration Trench.

\* Some credit can be taken for the side area that is frequently inundated as appropriate.

**Volume Reduction Calculations**

$$\text{Volume} = \text{Depth}^* \text{ (ft)} \times \text{Area (sf)} \times \text{Void Space}$$

\*Depth is the depth of the water surface during a storm event, depending on the drainage area and conveyance to the bed.

$$\text{Infiltration Volume} = \text{Bed Bottom Area (sf)} \times \text{Infiltration design rate (in/hr)} \\ \times \text{Infiltration period}^* \text{ (hr)} \times (1/12)$$

\*Infiltration Period is the time when bed is receiving runoff and capable of infiltration. Not to exceed 72 hours.

The void ratio in stone is approximately 40% for AASTO No 3. If the conveyance pipe is within the Storage Volume area, the volume of the pipe may also be included. All Infiltration Trenches should be designed to infiltrate or empty within 72 hours.

**Peak Rate Mitigation Calculations**

See Chapter 8 for Peak Rate Mitigation methodology which addresses link between volume reduction and peak rate control.

**Water Quality Improvement**

See Chapter 8 for Water Quality Improvement methodology which addresses pollutant removal effectiveness of this BMP.

**Construction Sequence**

1. Protect Infiltration Trench area from compaction prior to installation.
2. If possible, install Infiltration Trench during later phases of site construction to prevent sedimentation and/or damage from construction activity. After installation, prevent sediment laden water from entering inlets and pipes.
3. Install and maintain proper Erosion and Sediment Control Measures during construction.
4. Excavate Infiltration Trench bottom to a uniform, level uncompacted subgrade free from rocks and debris. Do NOT compact subgrade.
5. Place nonwoven geotextile along bottom and sides of trench\*. Nonwoven geotextile rolls should overlap by a minimum of 16 inches within the trench. Fold back and secure excess geotextile during stone placement.
6. Install upstream and downstream Control Structures, cleanouts, etc.
7. Place uniformly graded, clean-washed aggregate in 8-inch lifts, lightly compacting between lifts.
8. Install Continuously Perforated Pipe as indicated on plans. Backfill with uniformly graded, clean-washed aggregate in 8-inch lifts, lightly compacting between lifts.
9. Fold and secure nonwoven geotextile over Infiltration Trench, with minimum overlap of 16-inches.
10. Place 6-inch lift of approved Topsoil over Infiltration Trench, as indicated on plans.
11. Seed and stabilize topsoil.
12. Do not remove Inlet Protection or other Erosion and Sediment Control measures until site is fully stabilized.
13. Any sediment that enters inlets during construction is to be removed within 24 hours.





*(from left to right) Installation of Inlets and Control Structure; Non-woven Geotextile is folded over Infiltration Trench; Stabilized Site*



*(Clockwise from top left) Infiltration Trench is on downhill side of roadway; Infiltration Trench is installed; Infiltration Trench is paved with standard pavement material*

## Maintenance and Inspection Issues

- Catch Basins and Inlets should be inspected and cleaned at least 2 times per year.
- The vegetation along the surface of the Infiltration Trench should be maintained in good condition, and any bare spots revegetated as soon as possible.
- Vehicles should not be parked or driven on a vegetated Infiltration Trench, and care should be taken to avoid excessive compaction by mowers.

## Cost Issues

The construction cost of infiltration trenches can vary greatly depending on the configuration, location, site-specific conditions, etc. Typical construction costs in 2003 dollars range from \$4 - \$9 per cubic foot of storage provided (SWRPC, 1991; Brown and Schueler, 1997). Annual maintenance costs have been reported to be approximately 5 to 10 percent of the capital costs (Schueler, 1987).

## Specifications

The following specifications are provided for information purposes only. These specifications include information on acceptable materials for typical applications, but are by no means exclusive or limiting. The designer is responsible for developing detailed specifications for individual design projects in accordance with the project conditions.

**1. Stone** for infiltration trenches shall be 2-inch to 1-inch uniformly graded coarse aggregate, with a wash loss of no more than 0.5%, AASHTO size number 3 per AASHTO Specifications, Part I, 19th Ed., 1998, or later and shall have voids 40% as measured by ASTM-C29.

**2. Non-Woven Geotextile** shall consist of needled nonwoven polypropylene fibers and meet the following properties:

- a. Grab Tensile Strength (ASTM-D4632)
  - b. Mullen Burst Strength (ASTM-D3786)
  - c. Flow Rate (ASTM-D4491)
  - d. UV Resistance after 500 hrs (ASTM-D4355) 70%
  - e. Heat-set or heat-calendared fabrics are not permitted
- Acceptable types include Mirafi 140N, Amoco 4547, and Geotex 451.

**3. Pipe** shall be continuously perforated, smooth interior, with a minimum inside diameter of 8-inches. High-density polyethylene (HDPE) pipe shall meet AASHTO M252, Type S or AASHTO M294, Type S.

## References

Brown and Schueler, *Stormwater Management Fact Sheet: Infiltration Trench*. 1997.

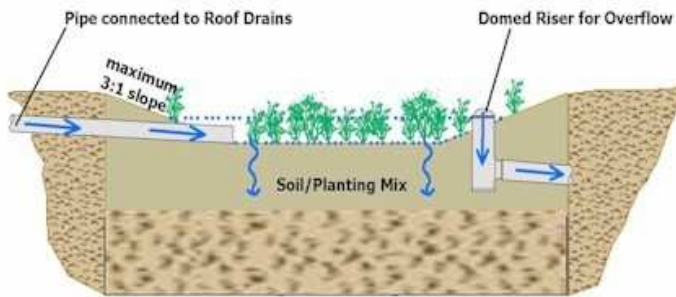
Schueler, T., 1987. *Controlling urban runoff: a practical manual for planning and designing urban BMPs*, Metropolitan Washington Council of Governments, Washington, DC

SWRPC, The Use of of Best Management Practices (BMPs) in Urban Watersheds, US Environmental Protection Agency, 1991.



## BMP 6.4.5: Rain Garden/Bioretention

### RECHARGE GARDEN / BIORETENTION BED



A Rain Garden (also called Bioretention) is an excavated shallow surface depression planted with specially selected native vegetation to treat and capture runoff.

<p style="text-align: center;"><b><u>Key Design Elements</u></b></p> <ul style="list-style-type: none"> <li>▪ Flexible in terms of size and infiltration</li> <li>▪ Ponding depths generally limited to 12 inches or less for aesthetics, safety, and rapid draw down. Certain situations may allow deeper ponding depths.</li> <li>▪ Deep rooted perennials and trees encouraged</li> <li>▪ Native vegetation that is tolerant of hydrologic variability, salts and environmental stress</li> <li>▪ Modify soil with compost.</li> <li>▪ Stable inflow/outflow conditions</li> <li>▪ Provide positive overflow</li> <li>▪ Maintenance to ensure long-term functionality</li> </ul>	<p style="text-align: center;"><b><u>Potential Applications</u></b></p> <p>Residential: Yes Yes                  Commercial: Ultra Yes                  Urban: Industrial: Yes Yes                  Retrofit: Yes Yes                  Highway/Road: Yes</p> <hr/> <p style="text-align: center;"><b><u>Stormwater Functions</u></b></p> <p>Volume Reduction: Medium                  Recharge: Med./High                  Peak Rate Control: Low/Med.                  Water Quality: Med./High</p> <hr/> <p style="text-align: center;"><b><u>Water Quality Functions</u></b></p> <p>TSS:                      TP: 85%    85%                                                   NO3: 30%</p>
---	--

### **Other Considerations**

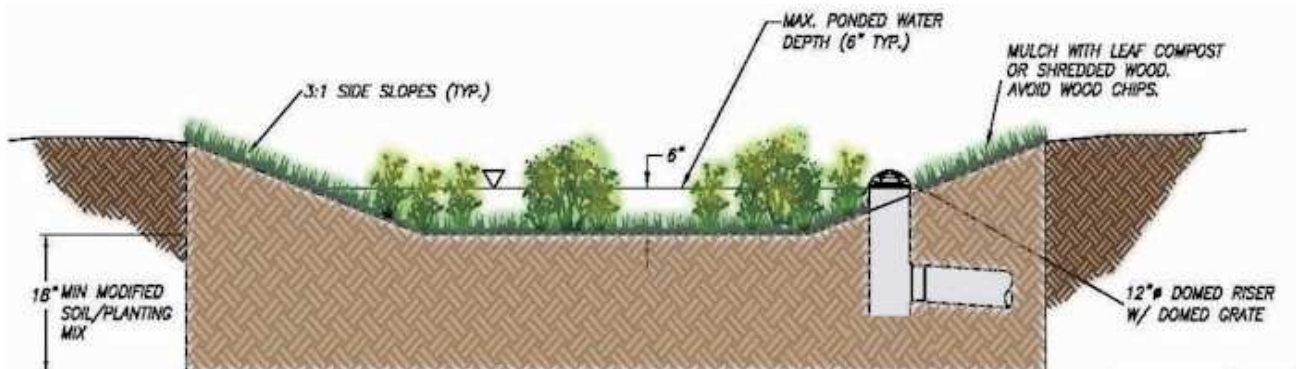
- **Protocol 1. Site Evaluation and Soil Infiltration Testing** and **Protocol 2. Infiltration Systems Guidelines** should be followed, see Appendix C

## Description

Bioretention is a method of treating stormwater by pooling water on the surface and allowing filtering and settling of suspended solids and sediment at the mulch layer, prior to entering the plant/soil/microbe complex media for infiltration and pollutant removal. Bioretention techniques are used to accomplish water quality improvement and water quantity reduction. Prince George’s County, Maryland, and Alexandria, Virginia have used this BMP since 1992 with success in many urban and suburban settings.

Bioretention can be integrated into a site with a high degree of flexibility and can balance nicely with other structural management systems, including porous asphalt parking lots, infiltration trenches, as well as non-structural stormwater BMPs described in Chapter 5.

The vegetation serves to filter (water quality) and transpire (water quantity) runoff, and the root systems can enhance infiltration. The plants take up pollutants; the soil medium filters out pollutants and allows storage and infiltration of stormwater runoff; and the bed provides additional volume control. Properly designed bioretention techniques mimic natural ecosystems through species diversity, density and distribution of vegetation, and the use of native species, resulting in a system that is resistant to insects, disease, pollution, and climatic stresses.



### Rain Gardens / Bioretention function to:

- Reduce runoff volume
- Filter pollutants, through both soil particles (which trap pollutants) and plant material (which take up pollutants)
- Recharge groundwater by infiltration
- Reduce stormwater temperature impacts
- Enhance evapotranspiration
- Enhance aesthetics
- Provide habitat



## Primary Components of a Rain Garden/Bioretention System

The primary components (and subcomponents) of a rain garden/bioretention system are:

### Pretreatment (optional)

- Sheet flow through a vegetated buffer strip, cleanout, water quality inlet, etc. prior to entry into the Rain Garden

### Flow entrance

- Varies with site use (e.g., parking island versus residential lot applications)
- Water may enter via an inlet (e.g., flared end section)
- Sheet flow into the facility over grassed areas
- Curb cuts with grading for sheet flow entrance
- Roof leaders with direct surface connection
- Trench drain
- Entering velocities should be non-erosive.

### Ponding area

- Provides temporary surface storage of runoff
- Provides evaporation for a portion of runoff
- Design depths allow sediment to settle
- Limited in depth for aesthetics and safety

### Plant material

- Evapotranspiration of stormwater
- Root development and rhizome community create pathways for infiltration
- Bacteria community resides within the root system creating healthy soil structure with water quality benefits
- Improves aesthetics for site
- Provides habitat for animals and insects
- Reinforces long-term performance of subsurface infiltration
- Should be tolerant of salts if in a location that would receive snow melt chemicals

### Organic layer or mulch

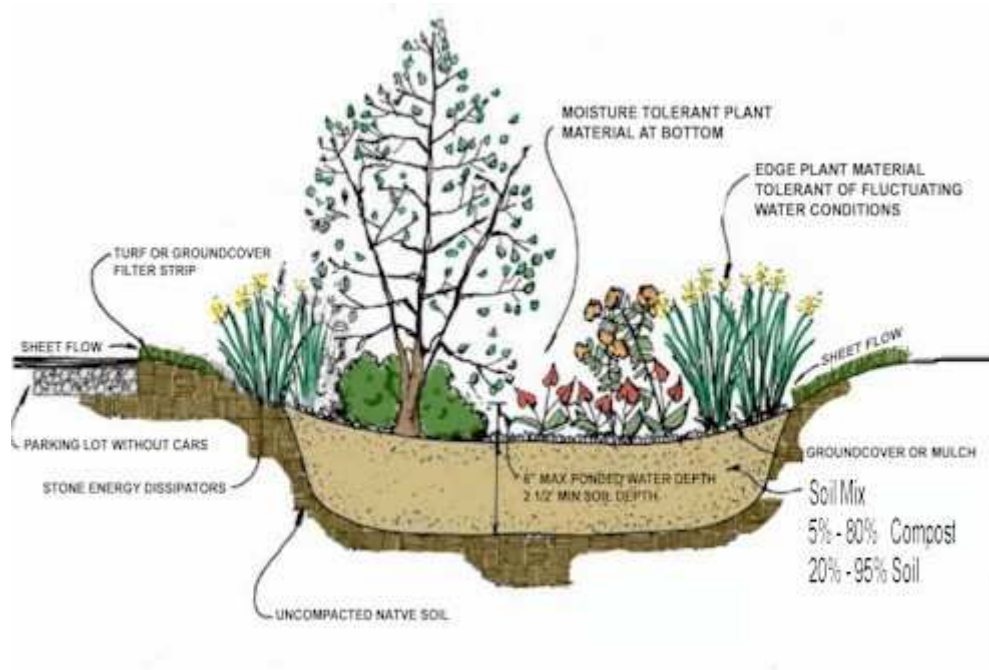
- Acts as a filter for pollutants in runoff
- Protects underlying soil from drying and eroding
- Simulates leaf litter by providing environment for microorganisms to degrade organic material
- Provides a medium for biological growth, decomposition of organic material, adsorption and bonding of heavy metals
- Wood mulch should be shredded - compost or leaf mulch is preferred.

### Planting soil/volume storage bed

- Provides water/nutrients to plants
- Enhances biological activity and encourages root growth
- Provides storage of stormwater by the voids within the soil particles

**Positive overflow**

- Will discharge runoff during large storm events when the storage capacity is exceeded. Examples include domed riser, inlet, weir structure, etc.
- An underdrain can be included in areas where infiltration is not possible or appropriate.



**Variations**

Generally, a Rain Garden/Bioretention system is a vegetated surface depression that provides for the infiltration of relatively small volumes of stormwater runoff, often managing stormwater on a lot-by-lot basis (versus the total development site). If greater volumes of runoff need to be managed or stored, the system can be designed with an expanded subsurface infiltration bed or the Bioretention area can be increased in size.

The design of a Rain Garden can vary in complexity depending on the quantity of runoff volume to be managed, as well as the pollutant reduction objectives for the entire site. Variations exist both in the components of the systems, which are a function of the land use surrounding the Bioretention system.

The most common variation includes a gravel or sand bed underneath the planting bed. The original intent of this design, however, was to perform as a filter BMP utilizing an under drain and subsequent discharge. When a designer decides to use a gravel or sand bed for volume storage under the planting bed, then additional design elements and changes in the vegetation plantings should be provided.

**Flow Entrance: Curbs and Curb Cuts**



**Flow Entrance: Trench Drain**



**Positive Overflow: Domed Riser**



**Positive Overflow: Inlet**



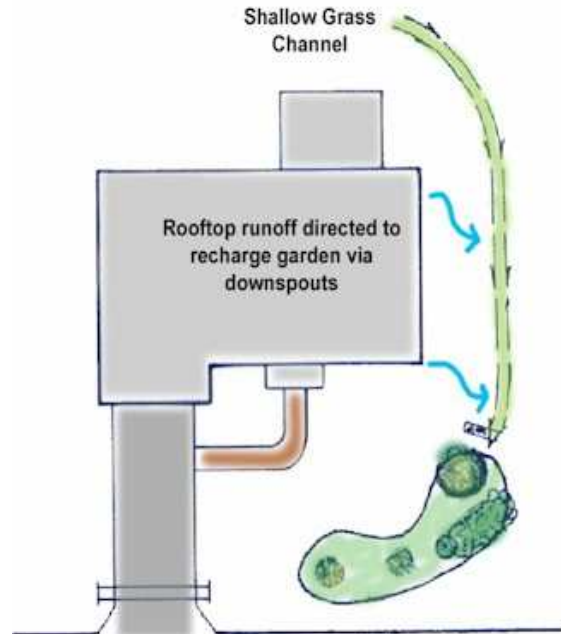
### Applications

Bioretention areas can be used in a variety of applications: from small areas in residential lawns to extensive systems in large parking lots (incorporated into parking islands and/or perimeter areas).

- Residential On-lot**

Rain Garden (Prince George’s County)

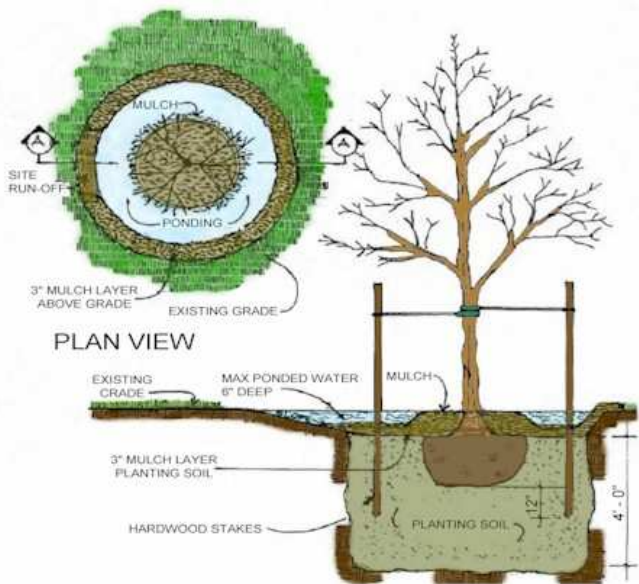
Simple design that incorporates a planting bed in the low portion of the site



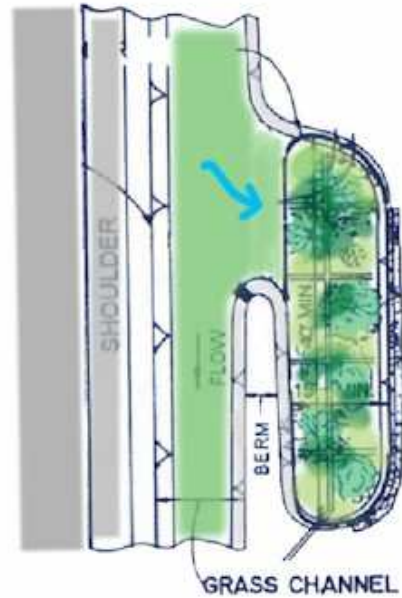
- Tree and Shrub Pits**

Stormwater management technique that intercepts runoff and provides shallow ponding in a dished mulched area around the tree or shrub.

Extend the mulched area to the tree dripline



- **Roads and highways**



- **Parking Lots**
- **Parking Lot Island Bioretention**



- **Commercial/Industrial/Institutional**

In commercial, industrial, and institutional situations, stormwater management and greenspace areas are limited, and in these situations, Rain Gardens for stormwater management and landscaping provide multifunctional options.

- **Curbless (Curb cuts) Parking Lot Perimeter Bioretention**

The Rain Garden is located adjacent to a parking area with no curb or curb cuts , allowing stormwater to sheet flow over the parking lot directly into the Rain Garden. Shallow grades should direct runoff at reasonable velocities; this design can be used in conjunction with depression storage for stormwater quantity control.



- **Curbed Parking Lot Perimeter Bioretention**



- **Roof leader connection from adjacent building**



## Design Considerations

Rain Gardens are flexible in design and can vary in complexity according to water quality objectives and runoff volume requirements. Though Rain Gardens are a structural BMP, the initial siting of bioretention areas should respect the Integrating Site Design Procedures described in Chapter 4 and integrated with the preventive non-structural BMPs.

It is important to note that bioretention areas are not to be confused with constructed wetlands or wet ponds which permanently pond water. Bioretention is best suited for areas with at least moderate infiltration rates (more than 0.1 inches per hour). In extreme situations where permeability is less than 0.1 inches per hour, special variants may apply, including under drains, or even constructed wetlands.

Rain Gardens are often very useful in retrofit projects and can be integrated into already developed lots and sites. An important concern for all Rain Garden applications is their long-term protection and maintenance, especially if undertaken in multiple residential lots where individual homeowners provide maintenance. In such situations, it is important to provide some sort of management that insures their long-term functioning (deed restrictions, covenants, and so forth).

### 1. Sizing criteria

- a. **Surface area** is dependent upon storage volume requirements but should generally not exceed a maximum loading ratio of 5:1 (impervious drainage area to infiltration area; see Protocol 2. Infiltration Systems Guidelines (Appendix C) for additional guidance on loading rates.)
- b. **Surface Side slopes** should be gradual. For most areas, maximum 3:1 side slopes are recommended, however where space is limited, 2:1 side slopes may be acceptable.
- c. **Surface Ponding depth** should not exceed 6 inches in most cases and should empty within 72 hours.
- d. **Ponding area** should provide sufficient surface area to meet required storage volume without exceeding the design ponding depth. The subsurface storage/infiltration bed is used to supplement surface storage where feasible.
- e. **Planting soil depth** should generally be at least 18" where only herbaceous plant species will be utilized. If trees and woody shrubs will be used, soil media depth may be increased, depending on plant species.

2. **Planting Soil** should be a loam soil capable of supporting a healthy vegetative cover. Soils should be amended with a composted organic material. A typical organic amended soil is combined with 20-30% organic material (compost), and 70-80% soil base (preferably topsoil). Planting soil should be approximately 4 inches deeper than the bottom of the largest root ball.
3. **Volume Storage Soils** should also have a pH of between 5.5 and 6.5 (better pollutant adsorption and microbial activity), a clay content less than 10% (a small amount of clay is beneficial to adsorb pollutants and retain water), be free of toxic substances and unwanted plant material and have a 5 –10% organic matter content. Additional organic matter can be added to the soil to increase water holding capacity (tests should be conducted to determine volume storage capacity of amended soils).

4. Proper **plant selection** is essential for bioretention areas to be effective. Typically, native floodplain plant species are best suited to the variable environmental conditions encountered. If shrubs and trees are included in a bioretention area (which is recommended), at least three species of shrub and tree should be planted at a rate of approximately 700 shrubs and 300 trees per acre (shrub to tree ratio should be 2:1 to 3:1). An experienced landscape architect is recommended to design native planting layout.
5. **Planting periods** will vary, but in general trees and shrubs should be planted from mid-March through the end of June, or mid-September through mid-November
6. A maximum of 2 to 3 inches of shredded **mulch** or leaf compost (or other comparable product) should be uniformly applied immediately after shrubs and trees are planted to prevent erosion, enhance metal removals, and simulate leaf litter in a natural forest system. Wood chips should be avoided as they tend to float during inundation periods. Mulch / compost layer should not exceed 3" in depth so as not to restrict oxygen flow to roots.
7. Must be designed carefully in areas with **steeper slopes** and should be aligned parallel to contours to minimize earthwork.
8. Under drains should not be used except where in-situ soils fail to drain surface water to meet the criteria in Chapter 3.

## Detailed Stormwater Functions

### Infiltration Area

#### Volume Reduction Calculations

The storage volume of a Bioretention area is defined as the sum total of 1. and the smaller of 2a or 2b below. The surface storage volume should account for at least 50% of the total storage. Inter-media void volumes may vary considerably based on design variations.

1. Surface Storage Volume (CF) = Bed Area (ft<sup>2</sup>) x Average Design Water Depth
- 2a. Infiltration Volume = Bed Bottom area (sq ft) x infiltration design rate (in/hr) x infiltration period (hr) x 1/12.
- 2b. Volume = Bed Bottom area (sq ft) x soil mix bed depth x void space.

### Peak Rate Mitigation

See Chapter 8 for Peak Rate Mitigation methodology, which addresses link between volume reduction and peak rate control.



## Water Quality Improvement

See Chapter 8 for Water Quality Improvement methodology, which addresses pollutant removal effectiveness of this BMP.

## Construction Sequence

The following is a typical construction sequence; however, alterations might be necessary depending on design variations.

1. Install temporary sediment control BMPs as shown on the plans.
2. Complete site grading. If applicable, construct curb cuts or other inflow entrance but provide protection so that drainage is prohibited from entering construction area.
3. Stabilize grading within the limit of disturbance except within the Rain Garden area. Rain garden bed areas may be used as temporary sediment traps provided that the proposed finish elevation of the bed is 12 inches lower than the bottom elevation of the sediment trap.
4. Excavate Rain Garden to proposed invert depth and scarify the existing soil surfaces. Do not compact in-situ soils.
5. Backfill Rain Garden with amended soil as shown on plans and specifications. Overfilling is recommended to account for settlement. Light hand tamping is acceptable if necessary.
6. Presoak the planting soil prior to planting vegetation to aid in settlement.
7. Complete final grading to achieve proposed design elevations, leaving space for upper layer of compost, mulch or topsoil as specified on plans.
8. Plant vegetation according to planting plan.
9. Mulch and install erosion protection at surface flow entrances where necessary.



## Maintenance Issues

Properly designed and installed Bioretention areas require some regular maintenance.

- While vegetation is being established, pruning and weeding may be required.
- Detritus may also need to be removed every year. Perennial plantings may be cut down at the end of the growing season.
- Mulch should be re-spread when erosion is evident and be replenished as needed. Once every 2 to 3 years the entire area may require mulch replacement.
- Bioretention areas should be inspected at least two times per year for sediment buildup, erosion, vegetative conditions, etc.
- During periods of extended drought, Bioretention areas may require watering.
- 
- Trees and shrubs should be inspected twice per year to evaluate health.

## Cost Issues

Rain Gardens often replace areas that would have been landscaped and are maintenance-intensive so that the net cost can be considerably less than the actual construction cost. In addition, the use of Rain Gardens can decrease the cost for stormwater conveyance systems at a site. Rain Gardens cost approximately \$5 to \$7 (2005) per cubic foot of storage to construct.

## Specifications

The following specifications are provided for informational purposes only. These specifications include information on acceptable materials for typical applications, but are by no means exclusive or limiting. The designer is responsible for developing detailed specifications for individual design projects in accordance with the project conditions.

### 1 Vegetation - See Appendix B

### 2 Execution

#### a. Subgrade preparation

1. Existing sub-grade in Bioretention areas shall NOT be compacted or subject to excessive construction equipment traffic.
2. Initial excavation can be performed during rough site grading but shall not be carried to within one feet of the final bottom elevation. Final excavation should not take place until all disturbed areas in the drainage area have been stabilized.
3. Where erosion of sub-grade has caused accumulation of fine materials and/or surface ponding in the graded bottom, this material shall be removed with light

equipment and the underlying soils scarified to a minimum depth of 6 inches with a York rake or equivalent by light tractor.

4. Bring sub-grade of bioretention area to line, grade, and elevations indicated. Fill and lightly regrade any areas damaged by erosion, ponding, or traffic compaction. All bioretention areas shall be level grade on the bottom.
5. Halt excavation and notify engineer immediately if evidence of sinkhole activity or pinnacles of carbonate bedrock are encountered in the bioretention area.

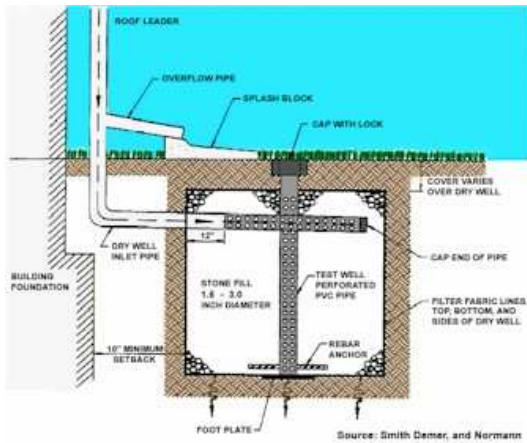
b. Rain Garden Installation

1. Upon completion of sub-grade work, the Engineer shall be notified and shall inspect at his/her discretion before proceeding with bioretention installation.
2. For the subsurface storage/infiltration bed installation, amended soils should be placed on the bottom to the specified depth.
3. Planting soil shall be placed immediately after approval of sub-grade preparation/bed installation. Any accumulation of debris or sediment that takes place after approval of sub-grade shall be removed prior to installation of planting soil at no extra cost to the Owner.
4. Install planting soil (exceeding all criteria) in 18-inch maximum lifts and lightly compact (tamp with backhoe bucket or by hand). Keep equipment movement over planting soil to a minimum – **do not over compact**. Install planting soil to grades indicated on the drawings.
5. Plant trees and shrubs according to supplier's recommendations and only from mid-March through the end of June or from mid-September through mid-November.
6. Install 2-3" shredded hardwood mulch (minimum age 6 months) or compost mulch evenly as shown on plans. Do not apply mulch in areas where ground cover is to be grass or where cover will be established by seeding.
7. Protect Rain Gardens from sediment at all times during construction. Hay bales, diversion berms and/or other appropriate measures shall be used at the toe of slopes that are adjacent to Rain Gardens to prevent sediment from washing into these areas during site development.
8. When the site is fully vegetated and the soil mantle stabilized the plan designer shall be notified and shall inspect the Rain Garden drainage area at his/her discretion before the area is brought online and sediment control devices removed.
9. Water vegetation at the end of each day for two weeks after planting is completed.

Contractor should provide a one-year 80% care and replacement warranty for all planting beginning after installation and inspection of all plants.



## BMP 6.4.6: Dry Well / Seepage Pit



A Dry Well, or Seepage Pit, is a variation on an Infiltration system that is designed to temporarily store and infiltrate rooftop runoff.

<p style="text-align: center;"><b><u>Key Design Elements</u></b></p> <ul style="list-style-type: none"> <li>▪ Follow Infiltration System Guidelines in Appendix C</li> <li>▪ Maintain minimum distance from building foundation (typically 10 feet)</li> <li>▪ Provide adequate overflow outlet for large storms</li> <li>▪ Depth of Dry Well aggregate should be between 18 and 48 inches</li> <li>▪ At least one observation well; clean out is recommended</li> <li>▪ Wrap aggregate with nonwoven geotextile</li> <li>▪ Maintenance will require periodic removal of sediment and leaves from sumps and cleanouts</li> <li>▪ Provide pretreatment for some situations</li> </ul>	<p style="text-align: center;"><b><u>Potential Applications</u></b></p> <p>Residential: Yes                  Commercial: Yes                  Ultra Urban: Yes                  Industrial: Limited                  Retrofit: Yes                  Highway/Road: No</p> <hr/> <p style="text-align: center;"><b><u>Stormwater Functions</u></b></p> <p>Volume Reduction: Medium                  Recharge: High                  Peak Rate Control: Medium                  Water Quality: Medium</p> <hr/> <p style="text-align: center;"><b><u>Water Quality Functions</u></b></p> <p>TSS: TP: 85% 85%                  NO3: 30%</p>
--	---

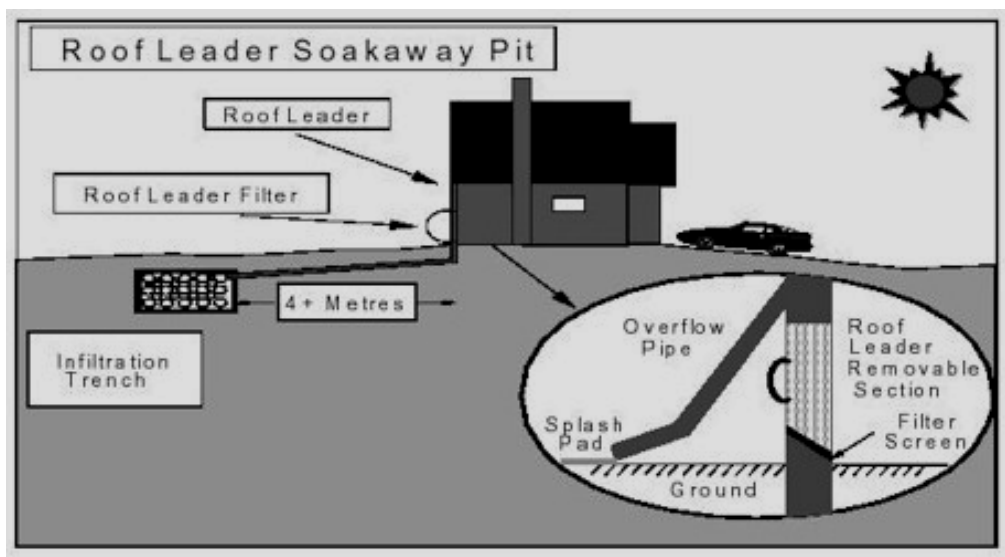
### Other Considerations

- **Protocol 1. Site Evaluation and Soil Infiltration Testing** and **Protocol 2. Infiltration Systems Guidelines** should be followed, see Appendix C

## Description

A Dry Well, sometimes called a Seepage Pit, is a subsurface storage facility that temporarily stores and infiltrates stormwater runoff from the roofs of structures. Roof leaders connect directly into the Dry Well, which may be either an excavated pit filled with uniformly graded aggregate wrapped in geotextile or a prefabricated storage chamber or pipe segment. Dry Wells discharge the stored runoff via infiltration into the surrounding soils. In the event that the Dry Well is overwhelmed in an intense storm event, an overflow mechanism (surcharge pipe, connection to larger infiltration area, etc.) will ensure that additional runoff is safely conveyed downstream.

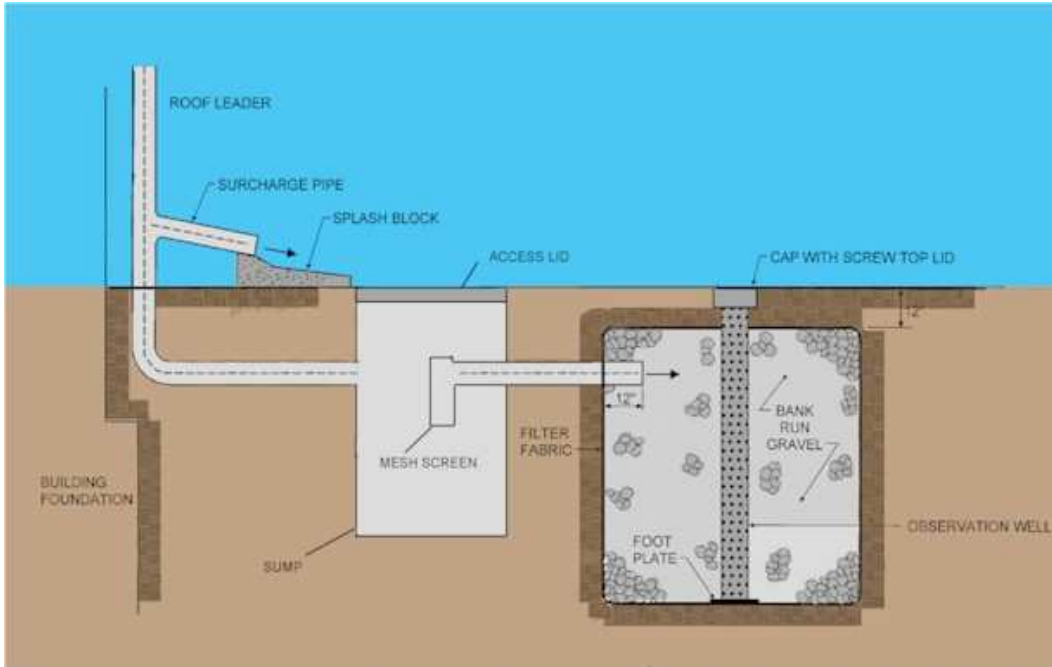
By capturing runoff at the source, Dry Wells can dramatically reduce the increased volume of stormwater generated by the roofs of structures. Though roofs are generally not a significant source of runoff pollution, they are still one of the most important sources of new or increased runoff volume from developed areas. By decreasing the volume of stormwater runoff, Dry Wells can also reduce runoff rate and improve water quality. As with other infiltration practices, Dry Wells may not be appropriate for “hot spots” or other areas where high pollutant or sediment loading is expected without additional design considerations. Dry Wells are not recommended within a specified distance to structures or subsurface sewage disposal systems. (see Appendix C, Protocol 2)



## Variations

**Intermediate “Sump” Box** – Water can flow through an intermediate box with an outflow higher to allow the sediments to settle out. Water would then flow through a mesh screen and into the dry well.

**Drain Without Gutters** – For structures without gutters or downspouts, runoff is designed to sheetflow off a pitched roof surface and onto a stabilized ground cover (surface aggregate, pavement, or other means). Runoff is then directed toward a Dry Well via stormwater pipes or swales.



**Prefabricated Dry Well** – There are a variety of prefabricated, predominantly plastic subsurface storage chambers on the market today that can replace aggregate Dry Wells. Since these systems have significantly greater storage capacity than aggregate, space requirements are reduced and associated costs may be defrayed. Provided the following design guidelines are followed and infiltration is still encouraged, prefabricated chambers can prove just as effective as standard aggregate Dry Wells.

**Applications**

Any roof or impervious area with relatively low sediment loading



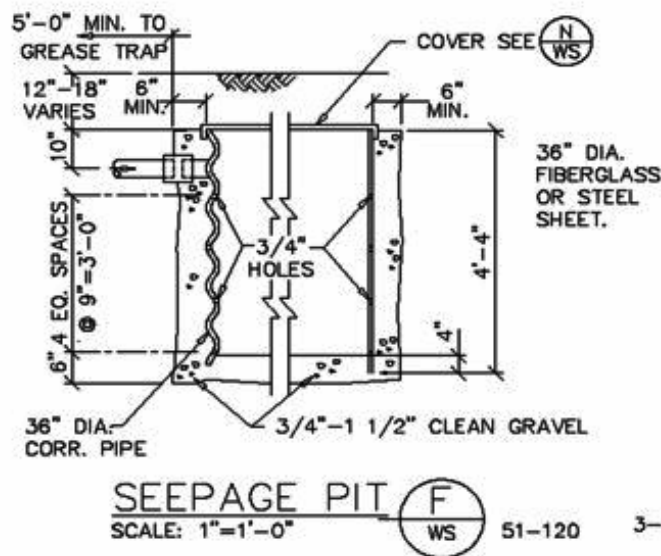
**Design Considerations**

1. Dry Wells are sized to temporarily retain and infiltrate stormwater runoff from roofs of structures. A dry well usually provides stormwater management for a limited roof area. Care should be taken not to hydraulically overload a dry well based on bottom area and drainage area. (See Appendix C, Protocol 2 for guidance)
2. Dry Wells should drain-down within the guidelines set in Chapter 3. Longer drain-down times reduce Dry Well efficiency and can lead to anaerobic conditions, odor and other problems.
3. Dry Wells typically consist of 18 to 48 inches of clean washed, uniformly graded aggregate with 40% void capacity (AASHTO No. 3, or similar). Dry Well aggregate is wrapped in a nonwoven geotextile, which provides separation between the aggregate and the surrounding soil. At least 12 inches of soil is then placed over the Dry Well. An alternative form of Dry Well is a subsurface, prefabricated chamber. A variety of prefabricated Dry Wells are currently available on the market.

4. Dry Wells are not recommended when their installation would create a significant risk for basement seepage or flooding. In general, 10 feet of separation is recommended between Dry Wells and building foundations. However, this distance may be shortened at the discretion of the designer. Shorter separation distances may warrant an impermeable liner to be installed on the building side of the Dry Well.
5. All Dry Wells should be able to convey system overflows to downstream drainage systems. System overflows can be incorporated either as surcharge (or overflow) pipes extending from roof leaders or via connections to more substantial infiltration areas.
6. The design depth of a Dry Well should take into account frost depth to prevent frost heave.
7. A removable filter with a screened bottom should be installed in the roof leader below the surcharge pipe in order to screen out leaves and other debris.
8. Adequate inspection and maintenance access to the Well should be provided. Observation wells not only provide the necessary access to the Well, but they also provide a conduit through which pumping of stored runoff can be accomplished in case of slowed infiltration.
9. Though roofs are generally not a significant source of runoff pollution, they can still be a source of particulates and organic matter, as well as sediment and debris during construction. Measures such as roof gutter guards, roof leader clean-out with sump, or an intermediate sump box can provide pretreatment for Dry Wells by minimizing the amount of sediment and other particulates that may enter it.

NOTE:

1. FABRICATE FROM 12 GA. STEEL SHEET, 12 GA. CORR. PIPE (STEEL OR ALUM.) OR 1/4" FIBERGLASS.
2. STEEL OPTIONS SHALL BE GALV. AFTER FABRICATION.
3. MIN. PERFORATIONS - 4 ROWS OF 3/4" HOLES, 8 HOLES PER ROW, ALL OPTIONS.





## Detailed Stormwater Functions

### Volume Reduction Calculations

The storage volume of a Dry Well is defined as the volume beneath the discharge invert. The following equation can be used to determine the approximate storage volume of an aggregate Dry Well:

Dry Well Volume = Dry well area (sf) x Dry well water depth (ft) x 40% (if stone filled)

Infiltration Area: A dry well may consider both bottom and side (lateral) infiltration according to design.

### Peak Rate Mitigation Calculations

See Chapter 8 for corresponding peak rate reduction.

## Water Quality Improvement

See Chapter 8

## Construction Sequence

1. Protect infiltration area from compaction prior to installation.
2. If possible, install Dry Wells during later phases of site construction to prevent sedimentation and/or damage from construction activity.
3. Install and maintain proper Erosion and Sediment Control Measures during construction as per the Pennsylvania Erosion and Sediment Pollution Control Program Manual (March 2000, or latest edition).
4. Excavate Dry Well bottom to a uniform, level uncompacted subgrade free from rocks and debris. Do NOT compact subgrade. To the greatest extent possible, excavation should be performed with the lightest practical equipment. Excavation equipment should be placed outside the limits of the Dry Well.
5. Completely wrap Dry Well with nonwoven geotextile. (If sediment and/or debris have accumulated in Dry Well bottom, remove prior to geotextile placement.) Geotextile rolls should overlap by a minimum of 24 inches within the trench. Fold back and secure excess geotextile during stone placement.
6. Install continuously perforated pipe, observation wells, and all other Dry Well structures. Connect roof leaders to structures as indicated on plans.
7. Place uniformly graded, clean-washed aggregate in 6-inch lifts, lightly compacting between lifts.
8. Fold and secure nonwoven geotextile over trench, with minimum overlap of 12-inches.
9. Place 12-inch lift of approved Topsoil over trench, as indicated on plans.
10. Seed and stabilize topsoil.
11. Connect surcharge pipe to roof leader and position over splashboard.

12. Do not remove Erosion and Sediment Control measures until site is fully stabilized.

**Maintenance Issues**

As with all infiltration practices, Dry Wells require regular and effective maintenance to ensure prolonged functioning. The following represent minimum maintenance requirements for Dry Wells:

- Inspect Dry Wells at least four times a year, as well as after every storm exceeding 1 inch.
- Dispose of sediment, debris/trash, and any other waste material removed from a Dry Well at suitable disposal/recycling sites and in compliance with local, state, and federal waste regulations.
- Evaluate the drain-down time of the Dry Well to ensure the maximum time of 72 hours is not being exceeded. If drain-down times are exceeding the maximum, drain the Dry Well via pumping and clean out perforated piping, if included. If slow drainage persists, the system may need replacing.
- Regularly clean out gutters and ensure proper connections to facilitate the effectiveness of the dry well.
- Replace filter screen that intercepts roof runoff as necessary.
- If an intermediate sump box exists, clean it out at least once per year.

**Cost Issues**

The construction cost of a Dry Well/Seepage Pit can vary greatly depending on design variability, configuration, location, site-specific conditions, etc. Typical construction costs in 2003 dollars range from \$4 - \$9 per cubic foot of storage volume provided (SWRPC, 1991; Brown and Schueler, 1997). Annual maintenance costs have been reported to be approximately 5 to 10 percent of the capital costs (Schueler, 1987). The cost of gutters is typically included in the total structure cost, as opposed

**Specifications**

The following specifications are provided for information purposes only. These specifications include information on acceptable materials for typical applications, but are by no means exclusive or limiting. The designer is responsible for developing detailed specifications for individual design projects in accordance with the project conditions.

**1. Stone** for infiltration trenches shall be 2-inch to 1-inch uniformly graded coarse aggregate, with a wash loss of no more than 0.5%, AASHTO size No. 3 per AASHTO Specifications, Part I, 19th Ed., 1998, or later and shall have voids 40% as measured by ASTM-C29.

**2. Nonwoven Geotextile** shall consist of needled nonwoven polypropylene fibers and meet the following properties:

- a. Grab Tensile Strength (ASTM-D4632) <sup>3</sup> 120 lbs
- b. Mullen Burst Strength (ASTM-D3786) <sup>3</sup> 225 psi
- c. Flow Rate (ASTM-D4491) <sup>3</sup> 95 gal/min/ft<sup>2</sup>
- d. UV Resistance after 500 hrs (ASTM-D4355) <sup>3</sup> 70%
- e. Heat-set or heat-calendared fabrics are not permitted  
Acceptable types include Mirafi 140N, Amoco 4547, and Geotex 451.

**3. Topsoil** See Appendix C

**4. Pipe** shall be continuously perforated, smooth interior, with a minimum inside diameter of 4-inches. High-density polyethylene (HDPE) pipe shall meet AASHTO M252, Type S or AASHTO M294, Type S. 12 gauge aluminum or corrugated steel pipe may be used in seepage pits.

**5. Gutters and splashboards** shall follow Manufacturer's specifications.

**References**

New Jersey Department of Environmental Protection. *New Jersey Stormwater Best Management Practices Manual*. 2004.

New York Department of Environmental Conservation. *New York State Stormwater Management Design Manual*. 2003.

French Drains. <http://www.unexco.com/french.html>. 2004.

SWRPC, The Use of Best Management Practices(BMPs) in Urban Watersheds, US Environmental Protection Agency,1991.

Brown and Schueler, *Stormwater Management Fact Sheet: Infiltration Trench*. 1997.

Schueler, T., 1987. *Controlling urban runoff: a practical manual for planning and designing urban BMPs*, Metropolitan Washington Council of Governments, Washington, DC



## BMP 6.4.7: Constructed Filter



Filters are structures or excavated areas containing a layer of sand, compost, organic material, peat, or other filter media that reduce pollutant levels in stormwater runoff by filtering sediments, metals, hydrocarbons, and other pollutants.

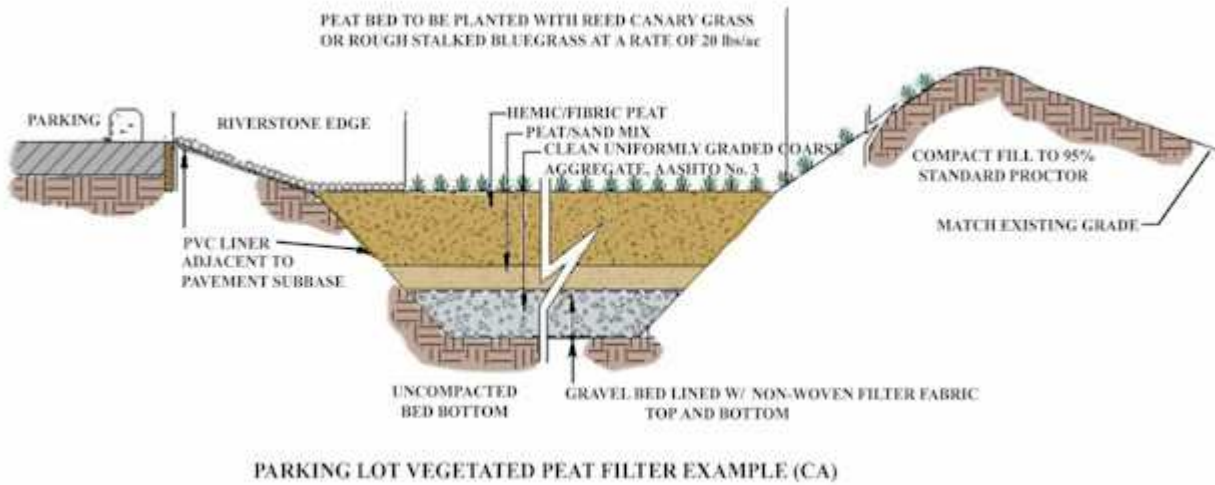
<p style="text-align: center;"><b><u>Key Design Elements</u></b></p> <ul style="list-style-type: none"> <li>▪ Follow Infiltration Systems Guidelines in Appendix C</li> <li>▪ Drain down – should empty within the guidelines in Chapter 3</li> <li>▪ Minimum permeability of filtration medium required</li> <li>▪ Minimum depth of filtering medium = 12"</li> <li>▪ Perforated pipes in stone, as required</li> <li>▪ May be designed to collect and convey filtered runoff down-gradient</li> <li>▪ May be designed to infiltrate</li> <li>▪ Pretreatment for debris and sediment may be needed</li> <li>▪ Should be sized for drainage area</li> <li>▪ Regular inspection and maintenance required for continued functioning</li> <li>▪ Positive overflow is needed</li> </ul>	<p style="text-align: center;"><b><u>Potential Applications</u></b></p> <p>Residential: Limited                  Commercial: Yes                  Ultra Urban: Yes                  Industrial: Yes                  Retrofit: Yes                  Highway/Road: Yes</p> <hr/> <p style="text-align: center;"><b><u>Stormwater Functions</u></b></p> <p>Volume Reduction: Low-High*                  Recharge: Low-High*                  Peak Rate Control: Low-High*                  Water Quality: High</p> <p><small>* Depends on if infiltration is used</small></p> <hr/> <p style="text-align: center;"><b><u>Water Quality Functions</u></b></p> <p>TSS: 85%                  TP: 85%                  NO3: 30%</p>
---	---

### **Other Considerations**

- **Protocol 1. Site Evaluation and Soil Infiltration Testing** and **Protocol 2. Infiltration Systems Guidelines** should be followed, see Appendix C
- Certain applications may warrant spill containment.

### Description

A stormwater filter is a structure or excavation filled with material and designed to filter stormwater runoff to improve water quality. The filter media may be comprised of materials such as sand, peat, compost, granular activated carbon (GAC), perlite, or other material. Additional filtration media will be acceptable for use as long as data is available to verify the media is capable of meeting performance goals. In some applications the stormwater runoff flows through an open air, “pretreatment” chamber to allow the large particles and debris to settle out (sedimentation). Surface vegetation is another good option for pretreatment. The runoff then passes through the filter media where additional pollutants are filtered out, and is collected in an under-drain and returned to the conveyance system, receiving waters or infiltrated into the soil mantle.



### Variations

There are a wide variety of Filter Applications, including surface and subsurface, vegetated, perimeter, infiltration, and others. There are also a variety of filter products that may be purchased. Examples of these variations include:

#### Surface Non-vegetated Filter

A Surface Non-vegetated Filter is constructed by excavation or by use of a structural container. The surface may be covered in sand, peat, gravel, river stone, or similar material.



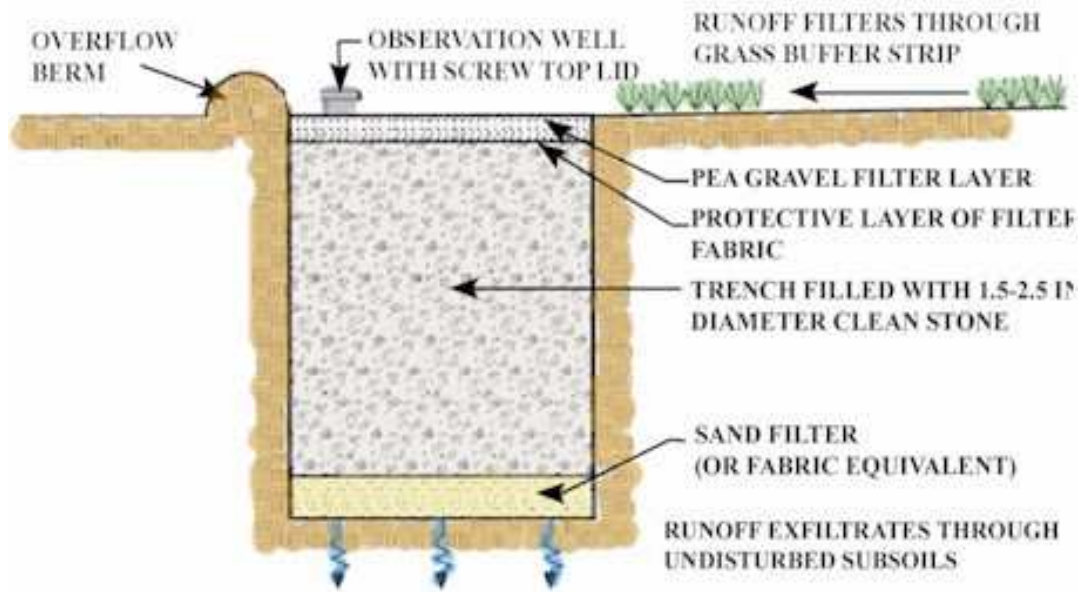
**Vegetated Filter**

A layer of vegetation is planted on top of the filtering medium. Composted amended soil may serve as a filter media. For filters composed of filtering media such as sand (where topsoil is required for vegetation) a layer of nonwoven, permeable geotextile should separate the topsoil and vegetation from the filter media.



**Infiltration Filter**

Filters may be designed to allow some portion of the treated water to infiltrate. Infiltration Design Criteria apply for all Filters designed with infiltration. In all cases, a positive overflow system is recommended.



**Contained Filter**

In contained Filters, infiltration is not incorporated into the design. Contained Filters may consist of a physical structure, such as a precast concrete box. For excavated filters, an impermeable liner is added to the bottom of the excavation to convey the filtered runoff downstream.



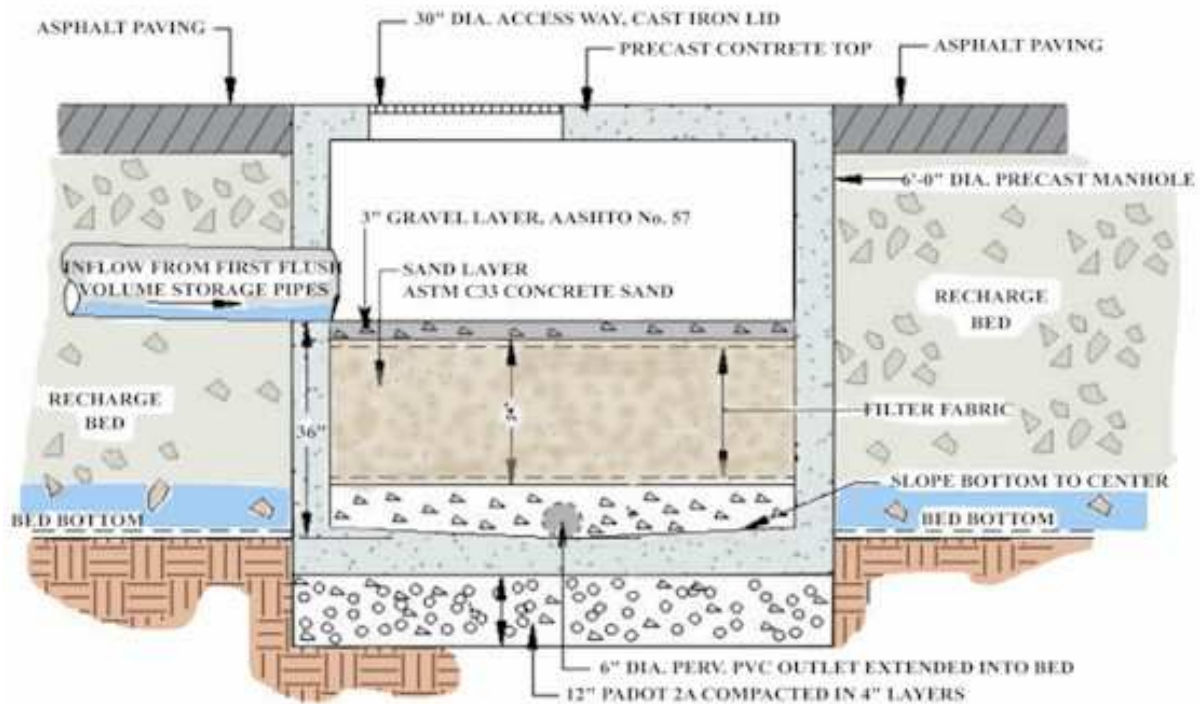
**Linear “Perimeter” Filters**

Perimeter Filters may consist of enclosed chambers (such as trench drains) that run along the perimeter of an impervious surface. Perimeter Filters may also be constructed by excavation and vegetated. All perimeter filters should be designed with the necessary filter medium and sized in accordance with the drainage area.



**Small Subsurface Filter**

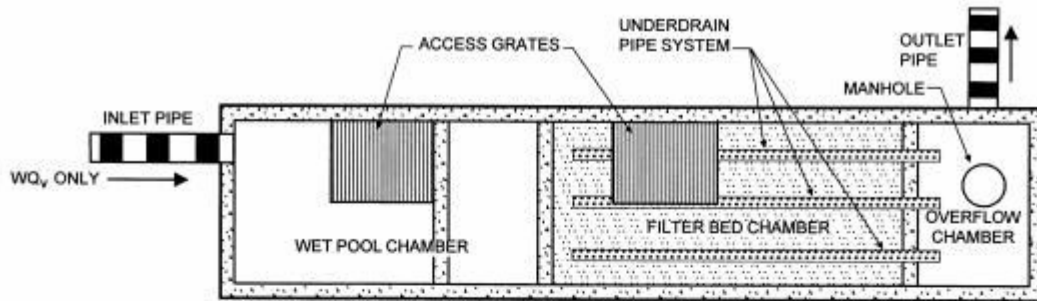
A Small Subsurface filter is an inlet designed to treat runoff at the collection source by filtration. Small Subsurface filters are useful for Hotspot Pretreatment and similar in function to Water Quality Inserts. Small Subsurface filters should be carefully designed and maintained so that runoff is directed through the filter media.



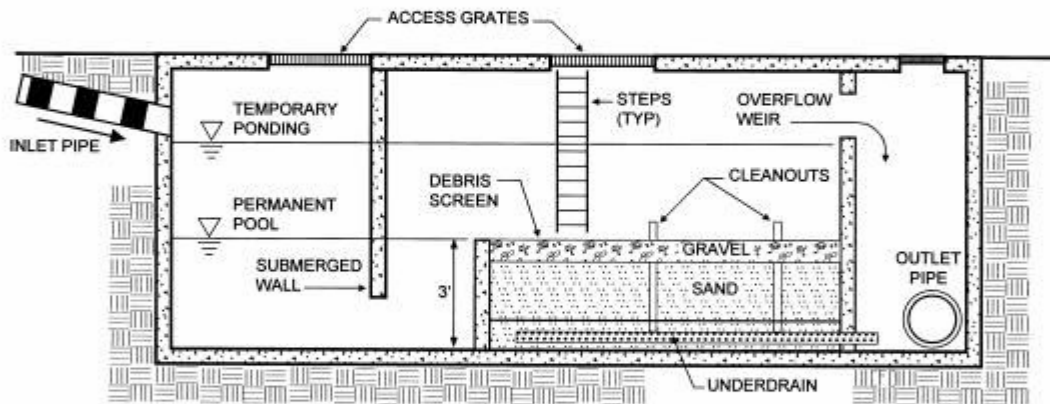


### Large Subsurface Filter

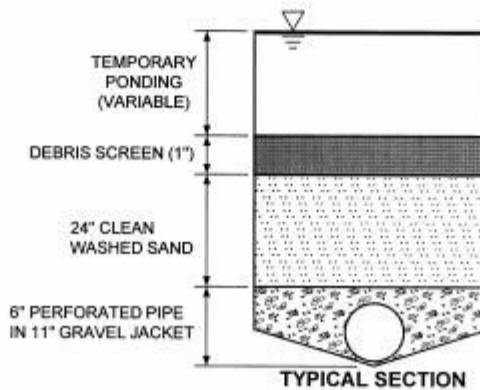
Large Subsurface Filters receive relatively large amounts of flow directed into an underground box that has separate chambers, one to settle large particles, and one to filter small particles. The water discharges through an outlet pipe and into the stormwater system.



**PLAN VIEW**



**PROFILE**



**TYPICAL SECTION**

## Manufactured Filtration Systems

There are a considerable number of manufactured filtration systems available, some of which also incorporate oil/water separators, vortex systems, etc. The Designer should obtain product specific information directly from the manufacturer.

## Applications

Filters are applicable in urbanized areas having high pollutant loads and are especially applicable where there is limited area for construction of other BMPs. Filters may be used as a pretreatment BMP before other BMPs such as Wet Ponds or Infiltration systems. Filters may be used in Hot Spot areas for water quality treatment, and spill containment capabilities may be incorporated into a filter. Examples of typical areas that benefit from the use of a Filter BMP include:

- Parking lots
- Roadways and Highways
- Light Industrial sites
- Marina areas
- Transportation facilities
- Fast food and shopping areas
- Waste Transfer Stations
- Urban Streetscapes

## Design Considerations

1. Filters should be sized as per the Control Guideline that applies. All filters should be designed so that **larger storms may safely overflow or bypass the filter**. Flow splitters, multistage chambers, and other devices may be used. A flow splitter may be necessary to allow only a portion of the runoff to enter the filter. This would create an “off-line” filter, where the volume and velocity of runoff entering the filter is controlled. If the filter is “on-line”, excess flow should be designed to bypass the filter and continue to another quality BMP.
2. **Entering velocity should be controlled**. A level spreader may be used to spread flow evenly across the filter surface during all storms without eroding the filter material. Parking lots may be designed to sheet flow to filters. Small riprap or riverstone edges may be used to reduce velocity and distribute flow.
3. **Pretreatment** may be necessary in areas with especially high levels of debris, large sediment, etc. Pretreatment may include oil/grit separators, vegetated filter strips, or grass swales. These measures will settle out the large particles and reduce velocity of the runoff before it enters the filter.
4. The **Filter Media** may be a variety of materials and in most cases should have a minimum depth of 12 inches and a maximum depth of 30 inches, although variations on these guidelines are acceptable if justified by the designer. Coarser materials allow for more hydraulic conductivity, but finer media filter particles of a smaller size. Sand has been found to be a good balance between these two criteria, but different types of media remove different pollutants. While sand is a reliable material to remove TSS, (Debusk and Langston, 1997) peat removes slightly more

TP, Cu, Cd, and Ni than sand. The Filter Media should have a minimum hydraulic conductivity (k) as follows:

- Sand 3.5 ft/day
- Peat 2.5 ft/day
- Leaf compost 8.7 ft/day

5. A **Gravel Layer** at least 6" deep is recommended beneath the Filter Media.
6. **Under drain piping** should be 4" minimum (diameter) perforated pipes, with a lateral spacing of no more than 10'. A collector pipe can be used, (running perpendicular to laterals) with a slope of 1%. All underground pipes should have clean-outs accessible from the surface.
7. A **Drawdown Time** of not more than 72 hours is recommended for Filters.
8. The **Size** of a Filter is determined by the Volume to be treated:

$$A = V \times d / (k \times t(h+d))$$

- A = Surface area of Filter (square feet)**
- V = Water volume (cubic feet)**
- d = Depth of Filter Media (min 1.5 ft; max 2.5 ft)**
- t = Drawdown time (days), not to exceed 72 hours**
- h = Head (average in feet)**
- k = Hydraulic conductivity (ft/day)**

9. When a Filter has accumulated sediment in its pore space, its hydraulic conductivity is reduced, and so is its ability to removal pollutants. **Maintenance and Inspection** are essential for continued performance of a Filter. Based upon inspection, some or all portions of the filter media may require replacement.
10. Filters should be designed with **sufficient maintenance access** (clean-outs, room for surface cleaning, etc.). Filters that are visible and simple in design are more likely to be maintained correctly.

## Detailed Stormwater Functions

### Volume Reduction Calculations

If a Filter is designed to include infiltration, the Volume Reduction is a function of the Area of the Filter and infiltration rate. There is minimal volume reduction for Filters that are not designed to infiltrate.

Volume = Infiltration Volume\* + Filter Volume

Infiltration Volume = Bottom Area (sf) x Infil. Rate (in/hr) x Drawdown time\*\* (hr)

Filter Volume = Area of filter (sf) x Depth (ft) x 20%\*\*\*

\*For filters with infiltration only

\*\* Not to exceed 72 hours

\*\*\*For sand, amended soil, compost, peat; Use 20% unless more specific data is available

### Peak Rate Mitigation Calculations

See Chapter 8 for Peak Rate Mitigation methodology which addresses link between volume reduction and peak rate control.

### Water Quality Improvement

See Chapter 8 for Water Quality Improvement methodology, which addresses pollutant removal effectiveness of this BMP.

### Construction Sequence

1. Permanent Filters should not be installed until the site is stabilized. Excessive sediment generated during construction can clog the Filter and prevent or reduce the anticipated post-construction water quality benefits. Stabilize all contributing areas before runoff enters filters.
2. Structures such as inlet boxes, reinforced concrete boxes, etc. should be installed in accordance with the manufacturers' or design engineers guidance.
3. Excavated filters that infiltrate or structural filters that infiltrate should be excavated in such a manner as to avoid compaction of the subbase. Structures may be set on a layer of clean, lightly compacted gravel (such as AASHTO #57).
4. Infiltration Filters should be underlain by a layer of permeable non-woven-geotextile.
5. Place underlying gravel/stone in minimum 6 inch lifts and lightly compact. Place underdrain pipes in gravel during placement.
6. Wrap and secure nonwoven geotextile to prevent gravel/stone from clogging with sediments.
7. Lay filtering material. Do not compact.
8. Saturate filter media and allow media to drain to properly settle and distribute.
9. For vegetated filters, a layer of nonwoven geotextile between non-organic filter media and planting media is recommended.
10. There should be sufficient space (head) between the top of the filtering bed and the overflow of the Filter to allow for the maximum head designed to be stored before filtration.



## Maintenance and Inspection

Filters require a regular inspection and maintenance program in order to maintain the integrity of the filtering system and pollutant removal mechanisms. Studies have shown that filters are very effective upon installation, but quickly decrease in efficiency as sediment accumulates in the filter. (Urbonas, Urban Drainage and Flood Control District, CO) Odor is also a concern for filters that are not maintained. Inspection of the filter is recommended at least **four times a year**.

During inspection the following conditions should be considered:

- **Standing water** – any water left in a surface filter after the design drain down time indicates the filter is not optimally functioning.
- **Film or discoloration** of any surface filter material – this indicates organics or debris have clogged the filter surface.



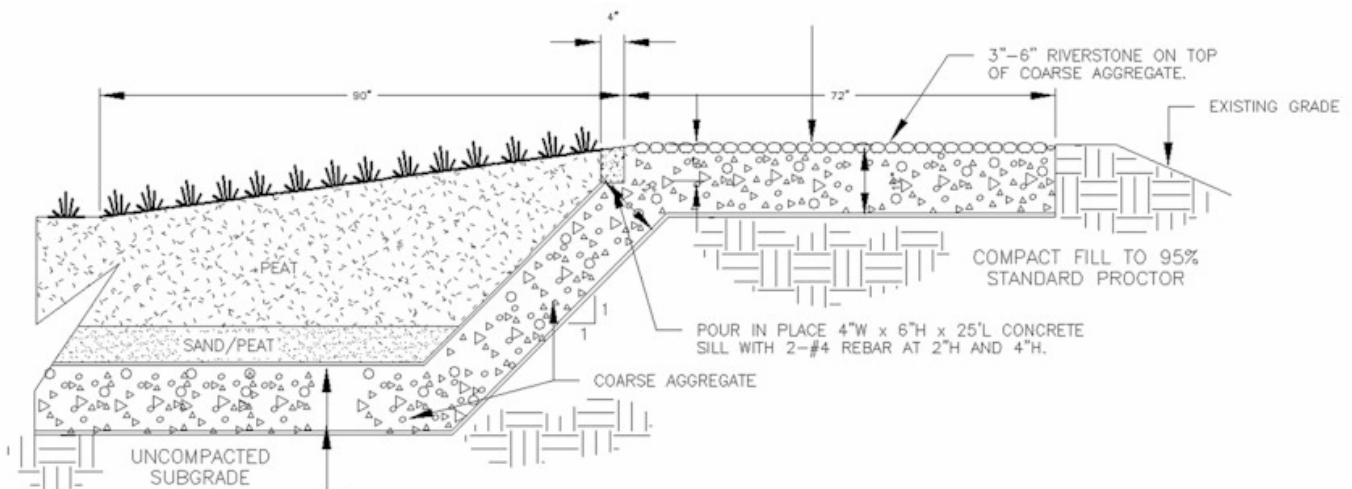
### Filter Maintenance

- Remove trash and debris as necessary
- Scrape silt with rakes
- Till and aerate filter area
- Replace filtering medium if scraping/removal has reduced depth of filtering media

In areas where the potential exists for the discharge and accumulation of toxic pollutants (such as metals), filter media removed from filters must be handled and disposed of in accordance with all state and federal regulations.

### Winter concerns

Pennsylvania's winter temperatures go below freezing about four months out of every year, and surface filtration may not take place as well in the winter. Peat and compost may hold water, freeze, and become impervious on the surface. Design options that allow directly for subsurface discharge into the filter media during cold weather may overcome this condition.



## Cost Issues

Filter costs vary according to the filtering medial (sand, peat, compost), land clearing, excavation, grading, inlet and outlet structures, perforated pipes, encasing structure (if used), and maintenance cost. Underground structures may contribute significantly to the cost of a Filter.

## Specifications

1. **Stone/Gravel** shall be uniformly graded coarse aggregate, 1 inch to ¾ inch with a wash loss of no more than 0.5%, AASHTO size number 57 per AASHTO Specifications, Part I, 19th Ed., 1998, or later and shall have voids 40% as measured by ASTM-C29.
2. **Peat** shall have ash content <15%, pH range 3.3-5.2, loose bulk density range 0.12-0.14 g/cc.
3. **Sand** shall be ASTM-C-33 (or AASHTO M-6) size (0.02” – 0.04”), concrete sand, clean, medium to fine sand, no organic material.
4. **Non-Woven Geotextile** shall consist of needled nonwoven polypropylene fibers and meet the following properties:
  - a. Grab Tensile Strength (ASTM-D4632)                   <sup>3</sup> 120 lbs
  - b. Mullen Burst Strength (ASTM-D3786)                   <sup>3</sup> 225 psi
  - c. Flow Rate (ASTM-D4491)                                   <sup>3</sup> 95 gal/min/ft<sup>2</sup>
  - d. UV Resistance after 500 hrs (ASTM-D4355)<sup>3</sup> 70%
  - e. Heat-set or heat-calendared fabrics are not permitted

Acceptable types include Mirafi 140N, Amoco 4547, Geotex 451, or approved others.

5. **Pipe** shall be continuously perforated, smooth interior, with a minimum inside diameter of 8-inches. High-density polyethylene (HDPE) pipe shall meet AASHTO M252, Type S or AASHTO M294, Type S.

## References

Atlanta Regional Commission. *Georgia Stormwater Management Manual*. August 2001.

University of Minnesota Extension Service, Northeast Regional Correction Center (NERCC)

“Field Evaluation of a Stormwater Sand Filter” Ben R. Urbonas, John T. Doerfer and L. Scott Tucker  
[www.udfcd.org/fhn96/flood1.html](http://www.udfcd.org/fhn96/flood1.html)

“An Evaluation of Filter Media For Treating Stormwater Runoff” Thomas A DeBustk and Michael A. Langston, Benfict Schwegler, Scott Davidson, Fifth Biennial Stormwater Research Conference, November, 1997

“A Denitrification System For Septic Tank Effluent Using Sphagnum Peat Moss” E. S. Winkler, and P. L. M. Veneman

“Stormwater Sand Filter Sizing and Design – A Unit Operations Approach” Urbonas

New York Department of Environmental Conservation. *New York Stormwater Management Manual*. 2003.

California Stormwater Quality Association. *California Stormwater BMP Handbook*. January 2003.





## BMP 6.4.8: Vegetated Swale



A Vegetated Swale is a broad, shallow, trapezoidal or parabolic channel, densely planted with a variety of trees, shrubs, and/or grasses. It is designed to attenuate and in some cases infiltrate runoff volume from adjacent impervious surfaces, allowing some pollutants to settle out in the process. In steeper slope situations, check dams may be used to further enhance attenuation and infiltration opportunities.

<p style="text-align: center;"><b><u>Key Design Elements</u></b></p> <ul style="list-style-type: none"> <li>▪ Plant dense, low-growing native vegetation that is water-resistant, drought and salt tolerant, providing substantial pollutant removal capabilities</li> <li>▪ Longitudinal slopes range from 1 to 6%</li> <li>▪ Side slopes range from 3:1 to 5:1</li> <li>▪ Bottom width of 2 to 8 feet</li> <li>▪ Check-dams can provide limited detention storage, as well as enhanced volume control through infiltration. Care must be taken to prevent erosion around the dam</li> <li>▪ Convey the 10-year storm event with a minimum of 6 inches of freeboard</li> <li>▪ Designed for non-erosive velocities up to the 10-year storm event</li> <li>▪ Design to aesthetically fit into the landscape, where possible</li> <li>▪ Significantly slow the rate of runoff conveyance compared to pipes</li> </ul>	<p style="text-align: center;"><b><u>Potential Applications</u></b></p> <p>Residential:  Commercial: Yes Yes  Ultra Urban: Limited  Industrial: Yes Yes  Retrofit: Yes  Highway/Road:</p> <hr/> <p style="text-align: center;"><b><u>Stormwater Functions</u></b></p> <p>Volume Reduction: Low/Med.  Recharge: Low/Med.  Peak Rate Control: Med./High  Water Quality: Med./High</p> <hr/> <p style="text-align: center;"><b><u>Water Quality Functions</u></b></p> <p>TSS: 50%  TP: 50%  NO3: 20%</p>
--	---

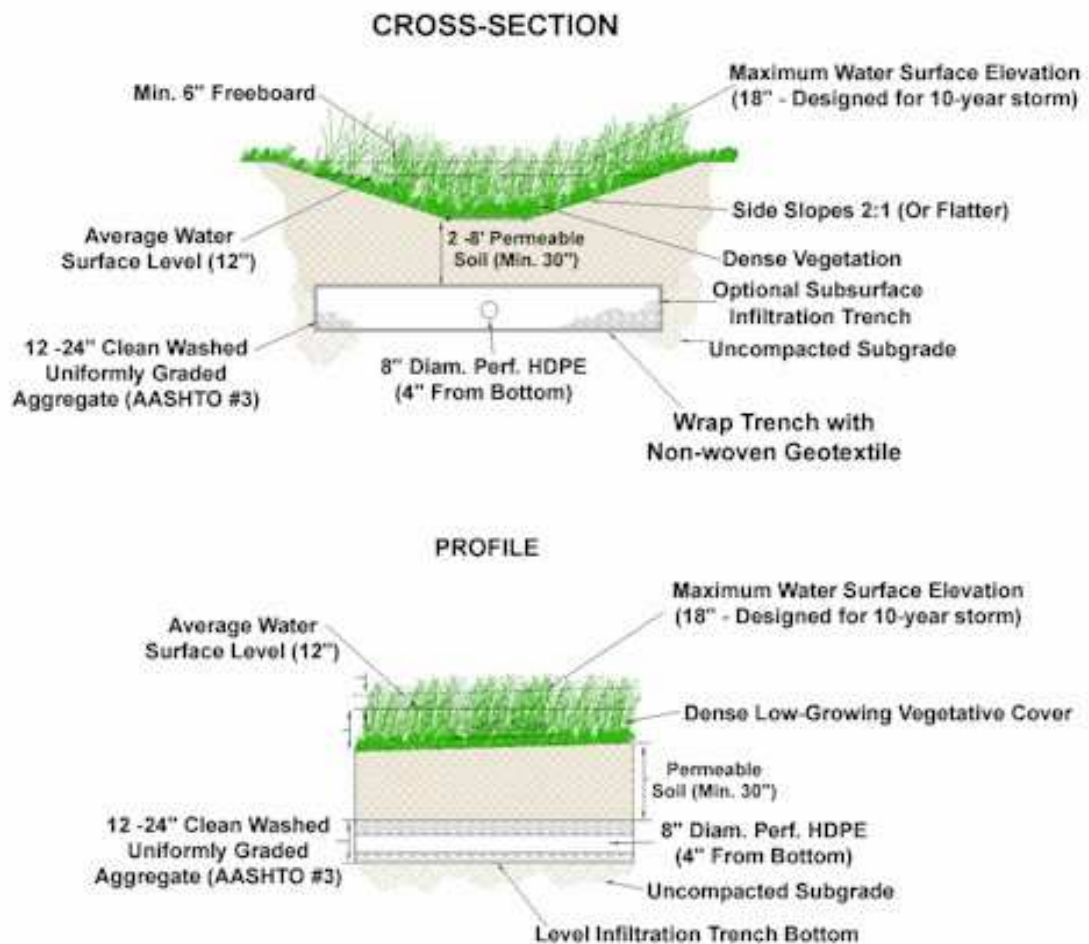
### **Other Considerations**

- **Protocol 1. Site Evaluation and Soil Infiltration Testing** and **Protocol 2. Infiltration Systems Guidelines** should be followed whenever infiltration of runoff is desired, see Appendix C

## Description

Vegetated swales are broad, shallow channels designed to slow runoff, promote infiltration, and filter pollutants and sediments in the process of conveying runoff. Vegetated Swales provide an environmentally superior alternative to conventional curb and gutter conveyance systems, while providing partially treated (pretreatment) and partially distributed stormwater flows to subsequent BMPs. Swales are often heavily vegetated with a dense and diverse selection of native, close-growing, water-resistant plants with high pollutant removal potential. The various pollutant removal mechanisms of a swale include: sedimentary filtering by the swale vegetation (both on side slopes and on bottom), filtering through a subsoil matrix, and/or infiltration into the underlying soils with the full array of infiltration-oriented pollutant removal mechanisms.

A Vegetated Swale typically consists of a band of dense vegetation, underlain by at least 24 inches of permeable soil. Swales constructed with an underlying 12 to 24 inch aggregate layer provide significant volume reduction and reduce the stormwater conveyance rate. The permeable soil media should have a minimum infiltration rate of 0.5 inches per hour and contain a high level of organic material to enhance pollutant removal. A nonwoven geotextile should completely wrap the aggregate trench (See BMP 6.4.4 Infiltration Trench for further design guidelines).



A major concern when designing Vegetated Swales is to make certain that excessive stormwater flows, slope, and other factors do not combine to produce erosive flows, which exceed the Vegetated Swale capabilities. Use of check dams or turf reinforcement matting (TRM) can enhance swale performance in some situations.

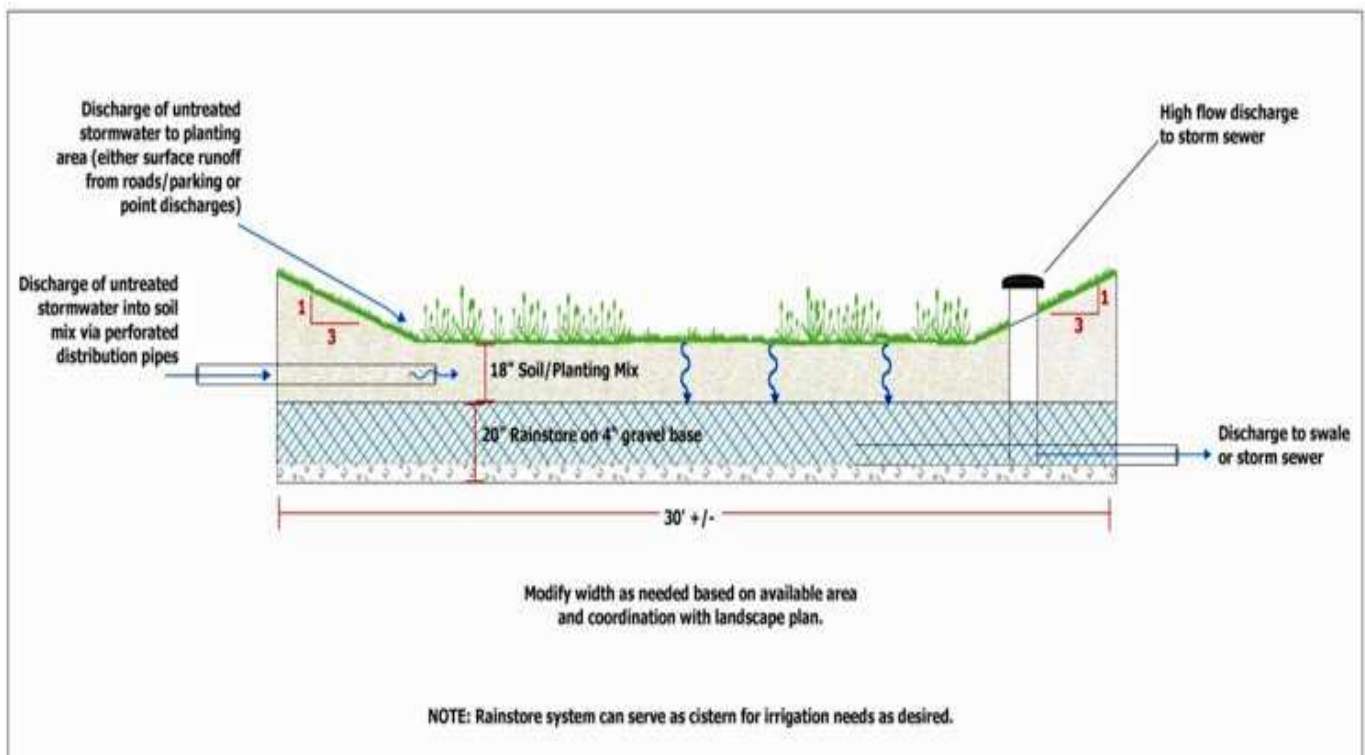
A key feature of vegetated swale design is that swales can be well integrated into the landscape character of the surrounding area. A vegetated swale can often enhance the aesthetic value of a site through the selection of appropriate native vegetation. Swales may also discreetly blend in with landscaping features, especially when adjacent to roads.



### Variations

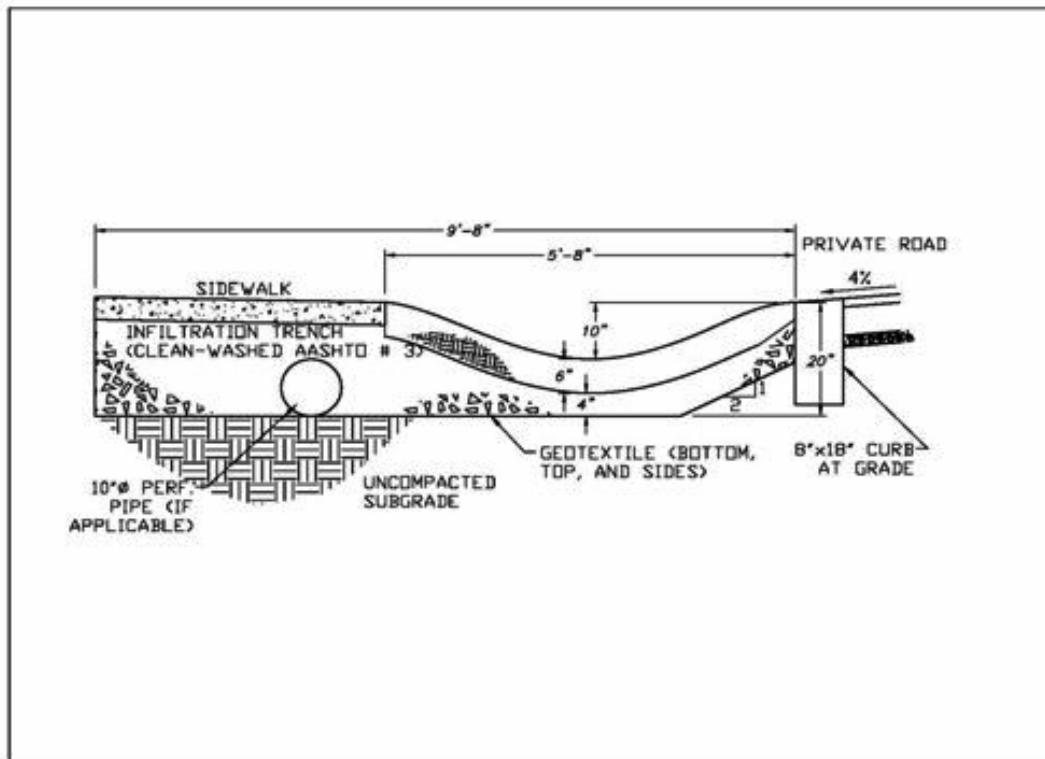
#### Vegetated Swale with Infiltration Trench

This option includes a 12 to 24 inch aggregate bed or trench, wrapped in a nonwoven geotextile (See BMP 6.4.4 Infiltration Trench for further design guidelines). This addition of an aggregate bed or trench substantially increases volume control and water quality performance although costs also are increased. Soil Testing and Infiltration Protocols in Appendix C should be followed.



Vegetated Swales with Infiltration Trenches are best fitted for milder sloped swales where the addition of the aggregate bed system is recommended to make sure that the maximum allowable ponding time of 72 hours is not exceeded. This aggregate bed system should consist of at least 12 inches of

uniformly graded aggregate. Ideally, the underdrain system shall be designed like an infiltration trench. The subsurface trench should be comprised of terraced levels, though sloping trench bottoms may also be acceptable. The storage capacity of the infiltration trench may be added to the surface storage volume to achieve the required storage of the 1-inch storm event.



**Grass Swale**

Grass swales are essentially conventional drainage ditches. They typically have milder side and longitudinal slopes than their vegetated counterparts. Grass swales are usually less expensive than swales with longer and denser vegetation. However, they provide far less infiltration and pollutant removal opportunities. Grass swales are to be used only as pretreatment for other structural BMPs. Design of grass swales is often rate-based. Grassed swales, where appropriate, are preferred over catch basins and pipes because of their ability to reduce the rate of flow across a site.



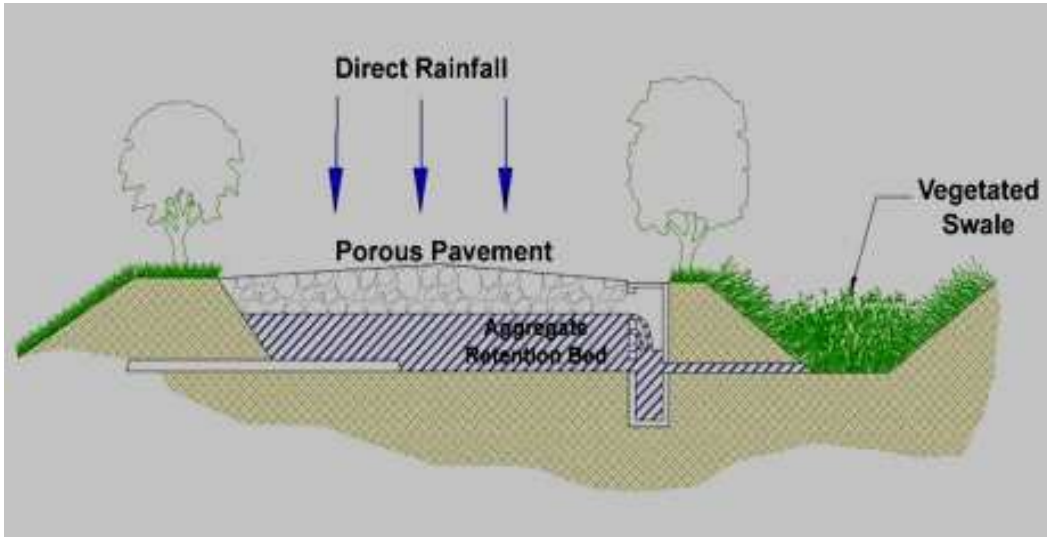
**Wet Swales**

Wet swales are essentially linear wetland cells. Their design often incorporates shallow, permanent pools or marshy conditions that can sustain wetland vegetation, which in turn provides potentially high pollutant removal. A high water table or poorly drained soils are a prerequisite for wet swales. The drawback with wet swales, at least in



residential or commercial settings, is that they may promote mosquito breeding in the shallow standing water (follow additional guidance under Constructed Wetland for reducing mosquito population). Infiltration is minimal if water remains for extended periods.

### Applications



- **Parking**
- **Commercial and light industrial facilities**
- **Roads and highways**
- **Residential developments**
- **Pretreatment for volume-based BMPs**
- **Alternative to curb/gutter and storm sewer**

### Design Considerations

1. Vegetated Swales are sized to temporarily store and infiltrate the 1-inch storm event, while providing conveyance for up to the 10-year storm with freeboard; flows for up to the 10-year storm are to be accommodated without causing erosion. Swales should maintain a maximum ponding depth of 18 inches at the end point of the channel, with a 12-inch average maintained throughout. Six inches of freeboard is recommended for the 10-year storm. Residence times between 5 and 9 minutes are acceptable for swales without check-dams. The maximum ponding time is 48 hours, though 24 hours is more desirable (minimum of 30 minutes). Studies have shown that the maximum amount of swale filtering occurs for water depths below 6 inches. It is critical that swale vegetation not be submerged, as it could cause the vegetation to bend over with the flow. This would naturally lead to reduced roughness of the swale, higher flow velocities, and reduced contact filtering opportunities.

2. Longitudinal slopes between 1% and 3% are generally recommended for swales. If the topography necessitates steeper slopes, check dams or TRM's are options to reduce the energy gradient and erosion potential.
3. Check dams are recommended for vegetated swales with longitudinal slopes greater than 3%. They are often employed to enhance infiltration capacity, decrease runoff volume, rate, and velocity, and promote additional filtering and settling of nutrients and other pollutants. In effect, check-dams create a series of small, temporary pools along the length of the swale, which shall drain down within a maximum of 72 hours. Swales with check-dams are much more effective at mitigating runoff quantity and quality than those without. The frequency and design of check-dams in a swale will depend on the swale length and slope, as well as the desired amount of storage/treatment volume. Care must be taken to avoid erosion around the ends of the check dams.



Check-dams shall be constructed to a height of 6 to 12 in and be regularly spaced. The following materials have been employed for check-dams: natural wood, concrete, stone, and earth. Earthen check-dams however, are typically not recommended due to their potential to erode. A weep hole(s) may be added to a check-dam to allow the retained volume to slowly drain out. Care should be taken to ensure that the weep hole(s) is not subject to clogging. In the case of a stone check-dam, a better approach might be to allow low flows (2-year storm) to drain through the stone, while allowing higher flows (10-year storm) drain through a weir in the center of the dam. Flows through a stone check-dam are a function of stone size, flow depth, flow width, and flow path length through the dam. The following equation can be used to estimate the flow through a stone check dam up to 6 feet long:

$$q = h^{1.5} / (L/D + 2.5 + L^2)^{0.5}$$

where:

- q = flow rate exiting check dam (cfs/ft)
- h = flow depth (ft)
- L = length of flow (ft)
- D = average stone diameter (ft) (more uniform gradations are preferred)

For low flows, check-dam geometry and swale width are actually more influential on flow than stone size. The average flow length through a check-dam as a function of flow depth can be determined by the following equation:

$$L = (ss) \times (2d - h)$$

where:

ss = check dam side slope (maximum 2:1)

d = height of dam (ft)

h = flow depth (ft)

When swale flows overwhelm the flow-through capacity of a stone check-dam, the top of the dam shall act as a standard weir (use standard weir equation). (Though a principal spillway, 6 inches below the height of the dam, may also be required depending on flow conditions.) If the check-dam is designed to be overtopped, appropriate selection of aggregate will ensure stability during flooding events. In general, one stone size for a dam is recommended for ease of construction. However, two or more stone sizes may be used, provided a larger stone (e.g. R-4) is placed on the downstream side, since flows are concentrated at the exit channel of the weir. Several feet of smaller stone (e.g. AASHTO #57) can then be placed on the upstream side. Smaller stone may also be more appropriate at the base of the dam for constructability purposes.

4. The effectiveness of a vegetated swale is directly related to the contributing land use, the size of the drainage area, the soil type, slope, drainage area imperviousness, proposed vegetation, and the swale dimensions. Use of natural low points in the topography may be suited for swale location, as are natural drainage courses although infiltration capability may also be reduced in these situations. The topography of a site should allow for the design of a swale with sufficiently mild slope and flow capacity. Swales are impractical in areas of extreme (very flat or steep) slopes. Of course, adequate space is needed for vegetated swales. Swales are ideal as an alternative to curbs and gutters along parking lots and along small roads in gently sloping terrain.

Siting of vegetated swales should take into account the location and function of other site features (buffers, undisturbed natural areas, etc.). Siting should also attempt to aesthetically fit the swale into the landscape as much as possible. Sharp bends in swales should be avoided.

Implementing vegetated swales is challenging when development density exceeds four dwelling units per acre, in which case the number of driveway culverts often increases to the point where swales essentially become broken-pipe systems.

Where possible, construct swales in areas of uncompacted cut. Avoid constructing side slopes in fill material. Fill slopes can be prone to erosion and/or structural damage by burrowing animals.

5. Soil Testing is required when infiltration is planned (see Appendix C).
6. Guidelines for Infiltration Systems should be met as necessary (see Appendix C).
7. Swales are typically most effective, when treating an area of 1 to 2 acres although vegetated swales can be used to treat and convey runoff from an area of 5 to 10 acres in size. Swales serving greater than 10-acre drainage areas will provide a lesser degree water quality treatment, unless special provisions are made to manage the increased flows.
8. Runoff can be directed into Vegetated Swales either as concentrated flows or as lateral sheet flow drainage. Both are acceptable provided sufficient stabilization or energy dissipation is

included (see #6). If flow is to be directed into a swale via curb cuts, provide a 2 to 3 inch drop at the interface of pavement and swale. Curb cuts should be at least 12 inches wide to prevent clogging and should be spaced appropriately.

9. Vegetated swales are sometimes used as pretreatment devices for other structural BMPs, especially roadway runoff. However, when swales themselves are intended to effectively treat runoff from highly impervious surfaces, pretreatment measures are recommended to enhance swale performance. Pretreatment can dramatically extend the functional life of any BMP, as well as increase its pollutant removal efficiency by settling out some of the heavier sediments. This treatment volume is typically obtained by installing check dams at pipe inlets and/or driveway crossings. Pretreatment options include a vegetated filter strip, a sediment forebay (or plunge pool) for concentrated flows, or a pea gravel diaphragm (or alternative) with a 6-inch drop where parking lot sheet flow is directed into a swale.
10. The soil base for a vegetated swale must provide stability and adequate support for proposed vegetation. When the existing site soil is deemed unsuitable (clayey, rocky, coarse sands, etc.) to support dense vegetation, replacing with approximately 12 inches of loamy or sandy soils is recommended. In general, alkaline soils should be used to further reduce and retain metals. Swale soils should also be well-drained. If the infiltration capacity is compromised during construction, the first several feet should be removed and replaced with a blend of topsoil and sand to promote infiltration and biological growth.
11. Swales are most efficient when their cross-sections are parabolic or trapezoidal in nature. Swale side slopes are best within a range of 3:1 to 5:1 and should not be greater than 2:1 for ease of maintenance and side inflow from sheet flow.
12. To ensure the filtration capacity and proper performance of swales, the bottom widths typically range from 2 to 8 feet. Wider channels are feasible only when obstructions such as berms or walls are employed to prohibit braiding or uncontrolled sub-channel formation. The maximum bottom width to depth ratio for a trapezoidal swale should be 12:1.
13. Ideal swale vegetation should consist of a dense and diverse selection of close-growing, water-resistant plants whose growing season preferably corresponds to the wet season. For swales that are not part of a regularly irrigated landscaped area, drought tolerant vegetation should be considered as well. Vegetation should be selected at an early stage in the design process, with well-defined pollution control goals in mind. Selected vegetation must be able to thrive at the specific site and therefore should be chosen carefully (See Appendix B). Use of native plant species is strongly advised, as is avoidance of invasive plant species. Swale vegetation must also be salt tolerant, if winter road maintenance activities are expected to contribute salt/chlorides.



Table 6.8.1

Commonly used vegetation in swale (New Jersey BMP Manual, 2004)		
Common Name	Scientific Name	Notes
Alkali Saltgrass	<i>Puccinellia distans</i>	Cool, good for wet, saline swales
Fowl Bluegrass	<i>Poa palustris</i>	Cool, good for wet swales
Canada Bluejoint	<i>Calamagrostis canadensis</i>	Cool, good for wet swales
Creeping Bentgrass	<i>Agrostis palustris</i>	Cool, good for wet swales, salt tolerant
Red Fescue	<i>Festuca rubra</i>	Cool, not for wet swales
Redtop	<i>Agrostis gigantea</i>	Cool, good for wet swales
Rough Bluegrass	<i>Poa trivialis</i>	Cool, good for wet, shady swales
Switchgrass	<i>Panicum virgatum</i>	Warm, good for wet swales, some salt tolerance
Wildrye	<i>Elymus virginicus/rigarius</i>	Cool, good for wet, shady swales

Notes: These grasses are sod forming and can withstand frequent inundation, and are ideal for the swale or grass channel environment. A few are also salt tolerant. Cool refers to cool season grasses that grow during the colder temperatures of spring and fall. Warm refers to warm season grasses that grow most vigorously during the hot, mid summer months.

By landscaping with trees along side slopes, swales can be easily and aesthetically integrated into the overall site design without unnecessary loss of usable space. An important consideration however, is that tree plantings allow enough light to pass and sustain a dense ground cover. When the trees have reached maturity, they should provide enough shade to markedly reduce high temperatures in swale runoff.

- Check the temporary and permanent stability of the swale using the standards outlined in the Pennsylvania Erosion and Sediment Pollution Control Program Manual. Swales should convey either 2.75 cfs/acre or the calculated peak discharge from a 10-year storm event. The permissible velocity design method may be used for design of channel linings for bed slopes <0.10 ft/ft; use of the maximum permissible shear stress is acceptable for all bed slopes. Flow capacity, velocity, and design depth in swales are generally calculated by Manning’s equation.

Prior to establishment of vegetation, a swale is particularly vulnerable to scour and erosion and therefore its seed bed must be protected with temporary erosion control, such as straw matting, compost blankets, or curled wood blankets. Most vendors will provide information about the Manning’s ‘n’ value and will specify the maximum permissible velocity or allowable shear stress for the lining material.

The post-vegetation establishment capacity of the swale should also be confirmed. Permanent turf reinforcement may supersede temporary reinforcement on sites where not exceeding the maximum permissible velocity is problematic. If driveways or roads cross a swale, culvert capacity may supersede Manning’s equation for determination of design flow depth. In these cases, the culvert should be checked to establish that the backwater elevation would not exceed the banks of the swale. If the culverts are to discharge to a minimum tailwater condition, the exit velocity for the culvert should be evaluated for design conditions. If the maximum permissible velocity is exceeded at the culvert outlet, energy dissipation measures should be implemented. The following tables list the maximum permissible shear stresses (for various channel liners) and velocities (for channels lined with vegetation) from the Pennsylvania Erosion and Sediment Pollution Control Program Manual.

**Maximum Permissible Shear Stresses for Various Channel Liners**

Lining Category	Lining Type	lb/ft <sup>2</sup>
Unlined - Erodible Soils*	Silts, Fine - Medium Sands	0.03
	Coarse Sands	0.04
	Very Coarse Sands	0.05
	Fine Gravel	0.10
Erosion Resistant Soils**	Clay loam	0.25
	Silty Clay loam	0.18
	Sandy Clay Loam	0.10
	Loam	0.07
	Silt Loam	0.12
	Sandy Loam	0.02
	Gravelly, Stony, Channery Loam	0.05
	Stony or Channery Silt Loam	0.07
Temporary Liners	Jute	0.45
	Straw with Net	1.45
	Coir - Double Net	2.25
	Coconut Fiber - Double Net	2.25
	Curled Wood Mat	1.55
	Curled Wood - Double Net	1.75
	Curled Wood - Hi Velocity	2.00
	Synthetic Mat	2.00
Vegetative Liners	Class B	2.10
	Class C	1.00
	Class D	0.60
Riprap***	R-1	0.25
	R-2	0.50
	R-3	1.00
	R-4	2.00
	R-5	3.00
	R-6	4.00
	R-7	5.00
	R-8	8.00

\* Soils having an erodibility "K" factor greater than 0.37

\*\* Soils having an erodibility "K" factor less than or equal to 0.37

\*\*\* Permissible shear stresses based on rock at 165 lb/cuft. Adjust velocities for other rock weights used. See Table 12.

Manufacturer's shear stress values based on independent tests may be used.

**Maximum Permissible Velocities for Channels Lined with Vegetation**

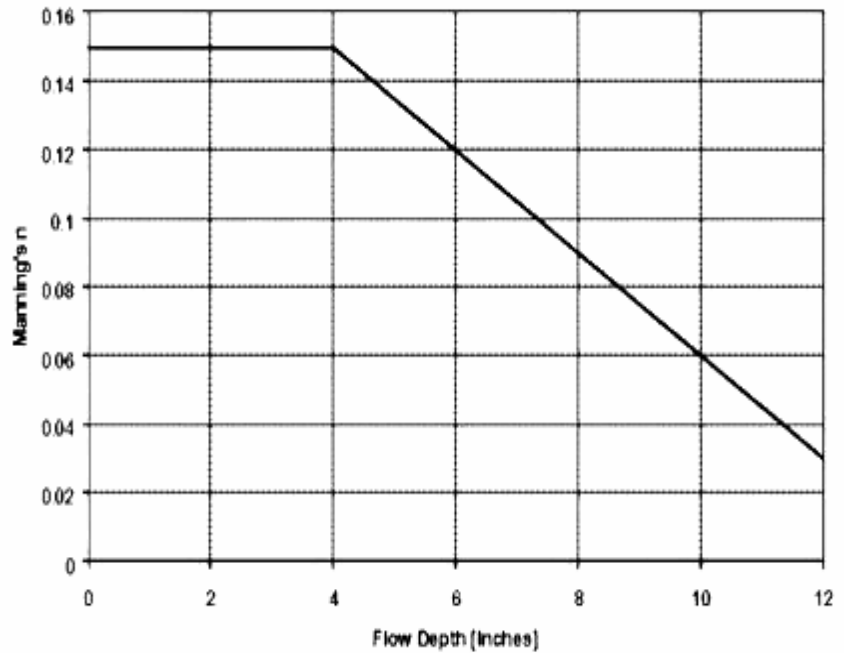
Cover	Slope Range Percent	Erosion resistant Soil <sup>1</sup>	Easily Eroded Soil <sup>2</sup>
Kentucky Bluegrass	<5	7 <sup>3</sup>	5
Tall Fescue	5-10	6 <sup>3</sup>	4
	>10	5	3
Grass Mixture	<5	5	4
Reed Canarygrass	5-10	4	3
Serecea Lespedeza	<5	3.5	2.5
Weeping Lovegrass			
Redtop			
Red Fescue			
Annuals	<5	3.5	2.5
Temporary cover only			
Sudangrass			

<sup>1</sup> Cohesive (clayey) fine grain soils and coarse grain soils with a plasticity index OF 10 TO 40 (CL, CH, SC and GC). Soils with K values less than 0.37.

<sup>2</sup> Soils with K values greater than 0.37.

<sup>3</sup> Use velocities exceeding 5 ft/sec only where good cover and proper maintenance can be obtained.

15. Manning's roughness coefficient, or 'n' value, varies with type of vegetative cover and design flow depth. Two common methods are based on design depth (see adjacent graph) and based on vegetative cover (as defined in the Pennsylvania Erosion and Sediment Pollution Control Program Manual). Either of these can be used in design.



**Figure D9.1 Manning's n Value with Varying Flow Depth (Source: Claytor and Schueler, 1986)**

- 16. If swales are designed according to the guidelines discussed in this section, significant levels of pollutant reduction can be expected through filtration and infiltration. In a particular swale reach, runoff should be well filtered by the time it flows over a check-dam. Thus, the stabilizing stone apron on the downhill side of the check-dam may be designed as an extension of an infiltration trench. In this way, only filtered runoff will enter a subsurface infiltration trench, thereby reducing the threat of groundwater contamination by metals.
- 17. Culverts are typically used in a vegetated swale at driveway or road crossings. By oversizing culverts and their flow capacity, cold weather concerns (e.g. clogging with snow) are lessened.
- 18. Where grades limit swale slope and culvert size, trench drains may be used to cross driveways.
- 19. Swales should discharge to another structural BMP (bioretention, infiltration basin, constructed wetlands, etc.), existing stormwater infrastructure, or a stable outfall.

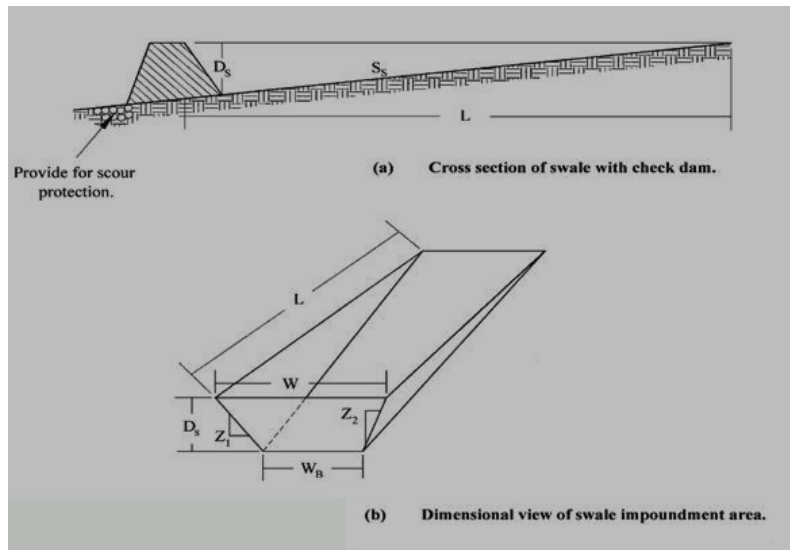
**Detailed Stormwater Functions**

**Infiltration Area (if needed)**

**Volume Reduction Calculations**

The volume retained behind each check-dam can be approximated from the following equation:

$$\text{Storage Volume} = 0.5 \times \text{Length of Swale Impoundment Area Per Check Dam} \times \text{Depth of Check Dam} \times (\text{Top Width of Check Dam} + \text{Bottom Width of Check Dam}) / 2$$



### Peak Rate Mitigation

See Chapter 8 for Peak Rate Mitigation methodology, which addresses link between volume reduction and peak rate control.

### Water Quality Improvement

See Chapter 8 for Water Quality Improvement methodology, which addresses pollutant removal effectiveness of this BMP.

### Construction Sequence

1. Begin vegetated swale construction only when the upgradient temporary erosion and sediment control measures are in place. Vegetated swales should be constructed and stabilized early in the construction schedule, preferably before mass earthwork and paving increase the rate and volume of runoff. (Erosion and sediment control methods shall adhere to the Pennsylvania Department of Environmental Protection’s *Erosion and Sediment Pollution Control Program Manual*, March 2000 or latest edition.)
2. Rough grade the vegetated swale. Equipment shall avoid excessive compaction and/or land disturbance. Excavating equipment should operate from the side of the swale and never on the bottom. If excavation leads to substantial compaction of the subgrade (where an infiltration trench is not proposed), 18 inches shall be removed and replaced with a blend of topsoil and sand to promote infiltration and biological growth. At the very least, topsoil shall be thoroughly deep plowed into the subgrade in order to penetrate the compacted zone and promote aeration and the formation of macropores. Following this, the area should be disked prior to final grading of topsoil.
3. Construct check dams, if required.
4. Fine grade the vegetated swale. Accurate grading is crucial for swales. Even the smallest non-conformities may compromise flow conditions.

5. Seed, vegetate and install protective lining as per approved plans and according to final planting list. Plant the swale at a time of the year when successful establishment without irrigation is most likely. However, temporary irrigation may be needed in periods of little rain or drought. Vegetation should be established as soon as possible to prevent erosion and scour.
6. Once all tributary areas are sufficiently stabilized, remove temporary erosion and sediment controls. It is very important that the swale be stabilized before receiving upland stormwater flow.
7. Follow maintenance guidelines, as discussed below.

Note: If a vegetated swale is used for runoff conveyance during construction, it should be regraded and reseeded immediately after construction and stabilization has occurred. Any damaged areas should be fully restored to ensure future functionality of the swale.

### **Maintenance Issues**

Compared to other stormwater management measures, the required upkeep of vegetated swales is relatively low. In general, maintenance strategies for swales focus on sustaining the hydraulic and pollutant removal efficiency of the channel, as well as maintaining a dense vegetative cover. Experience has proven that proper maintenance activities ensure the functionality of vegetated swales for many years. The following schedule of inspection and maintenance activities is recommended:

#### **Maintenance activities to be done annually and within 48 hours after every major storm event (> 1 inch rainfall depth):**

- Inspect and correct erosion problems, damage to vegetation, and sediment and debris accumulation (address when > 3 inches at any spot or covering vegetation)
- Inspect vegetation on side slopes for erosion and formation of rills or gullies, correct as needed
- Inspect for pools of standing water; dewater and discharge to an approved location and restore to design grade
- Mow and trim vegetation to ensure safety, aesthetics, proper swale operation, or to suppress weeds and invasive vegetation; dispose of cuttings in a local composting facility; mow only when swale is dry to avoid rutting
- Inspect for litter; remove prior to mowing
- Inspect for uniformity in cross-section and longitudinal slope, correct as needed
- Inspect swale inlet (curb cuts, pipes, etc.) and outlet for signs of erosion or blockage, correct as needed

#### **Maintenance activities to be done as needed:**

- Plant alternative grass species in the event of unsuccessful establishment

- Reseed bare areas; install appropriate erosion control measures when native soil is exposed or erosion channels are forming
- Rototill and replant swale if draw down time is more than 48 hours
- Inspect and correct check dams when signs of altered water flow (channelization, obstructions, erosion, etc.) are identified
- Water during dry periods, fertilize, and apply pesticide **only when absolutely necessary**

Most of the above maintenance activities are reasonably within the ability of individual homeowners. More intensive swales (i.e. more substantial vegetation, check dams, etc.) may warrant more intensive maintenance duties and should be vested with a responsible agency. A legally binding and enforceable maintenance agreement between the facility owner and the local review authority might be warranted to ensure sustained maintenance execution. Winter conditions also necessitate additional maintenance concerns, which include the following:

- Inspect swale immediately after the spring melt, remove residuals (e.g. sand) and replace damaged vegetation without disturbing remaining vegetation.
- If roadside or parking lot runoff is directed to the swale, mulching and/or soil aeration/manipulation may be required in the spring to restore soil structure and moisture capacity and to reduce the impacts of deicing agents.
- Use nontoxic, organic deicing agents, applied either as blended, magnesium chloride-based liquid products or as pretreated salt.
- Use salt-tolerant vegetation in swales.

**Cost Issues**

As with all other BMPs, the cost of installing and maintaining Vegetated Swales varies widely with design variability, local labor/material rates, real estate value, and contingencies. In general, Vegetated Swales are considered relatively low cost control measures. Moreover, experience has shown that Vegetated Swales provide a cost-effective alternative to traditional curbs and gutters, including associated underground storm sewers. The following table compares the cost of a typical vegetated swale (15 ft top width) with the cost of traditional conveyance elements.

Structure:	Swale	Underground Pipe	Curb & Gutter
Construction Cost (per linear foot)	\$4.50 - \$8.50 (from seed) \$15 - \$20 (from sod)	\$2 per foot per inch of diameter	\$13 - \$15
Annual O&M cost (per linear foot)	\$0.75	No data	No data
Total Annual Cost (per linear foot)	\$1 (from seed)      \$2 (from sod)	No data	No data
Lifetime (years)	50		20

It is important to note that the costs listed above are strictly estimates and shall be used for design purposes only. Also, these costs do not include the cost of activities such as clearing, grubbing, leveling, filling, and sodding (if required). The Southeastern Wisconsin Regional Planning Commission (SEWRPC, 1991) reported that actual costs, which do include these activities, may range from \$8.50 to \$50.00 per linear foot depending on swale depth and bottom width. When all pertinent construction activities are considered, it is still likely that the cost of vegetated swale installation is less than that of traditional conveyance elements. When annual operation and maintenance costs are considered however, swales may prove the more expensive option, though they typically have a much longer lifespan.

### Specifications

The following specifications are provided for information purposes only. These specifications include information on acceptable materials for typical applications, but are by no means exclusive or limiting. The designer is responsible for developing detailed specifications for individual design projects in accordance with the project conditions.

1. **Swale Soil** shall be USCS class ML (Inorganic silts and very fine sands, rock flour, silty or clayey fine sands with slight plasticity), SM (Silty sands, poorly graded sand-silt mixtures), SW (Well-graded sands, gravelly sands, little or no fines) or SC (Clayey sands, poorly graded sand-clay mixtures). The first three of these designations are preferred for swales in cold climates. In general, soil with a higher percent organic content is preferred.
2. **Swale Sand** shall be ASTM C-33 fine aggregate concrete sand (0.02 in to 0.04 in).
3. **Check dams** constructed of natural wood shall be 6 in to 12 in diameter and notched as necessary. The following species are acceptable: Black Locust, Red Mulberry, Cedars, Catalpa, White Oak, Chestnut Oak, Black Walnut. The following species are not acceptable, as they can rot over time: Ash, Beech, Birch, Elm, Hackberry, hemlock, Hickories, Maples, Red and Black Oak, Pines, Poplar, Spruce, Sweetgum, and Willow. An earthen **check dam** shall be constructed of sand, gravel, and sandy loam to encourage grass cover (Sand: ASTM C-33 fine aggregate concrete sand 0.02 in to 0.04 in, Gravel: AASHTO M-43 0.5 in to 1.0 in). A stone **check dam** shall be constructed of R-4 rip rap, or equivalent.
4. Develop a native **planting mix**. (see Appendix B)
5. If infiltration trench is proposed, see BMP 6.4.4 Infiltration Trench for specifications.

### References

Alameda Countywide Clean Water Program (ACCWP). "Grassy Swales." *Catalog of Control Measures*. <[http://www.oaklandpw.com/creeks/pdf/Grassy\\_Swales.pdf](http://www.oaklandpw.com/creeks/pdf/Grassy_Swales.pdf)>

AMEC Earth and Environmental Center for Watershed Protection et al. *Georgia Stormwater Management Manual*. 2001.

California Stormwater Quality Association. *California Stormwater Best Management Practices Handbook: New Development and Redevelopment*. 2003.

Caraco and Claytor. *Stormwater BMP Design Supplement for Cold Climates*. 1997.

- City of Portland Environmental Services. *City of Portland Stormwater Management Manual: Revision #2*. 2002.
- Center for Watershed Protection and Maryland Department of the Environment. *2000 Maryland Stormwater Design Manual*. Baltimore, MD: 2000.
- Claytor, R.A. and T.R. Schuler. *Design of Stormwater Filtering Systems*. Center for Watershed Protection. Silver Spring, MD: 1996.
- Colwell, S. R. et al. *Characterization of Performance Predictors and Evaluation of Mowing Practices in Biofiltration Swales*. 2000.
- Fletcher, T., Wong, T., and Breen, P. "Chapter 8 – Buffer Strips, Vegetated Swales and Bioretention Systems." *Australian Runoff Quality (Draft)*. University of New Castle – Australia.
- Lichten, K. "Grassy Swales." BMP Fact Sheets. Bay Area Stormwater Management Agencies Association (BASMAA). 1997.
- Maine Department of Transportation. *Maine Department of Transportation BMP Manual for Erosion and Sedimentation Control*. 1992.
- North Central Texas Council of Governments. *Stormwater Best Management Practices: A Menu of Management Plan Options for Small MS4s in North Central Texas*. 2002.
- Schueler, T. et al. *A Current Assessment of Urban Best Management Practices: Techniques for Reducing Nonpoint Source Pollution in the Coastal Zone*. 1992.
- United States Environmental Protection Agency (USEPA). "Post-Construction Storm Water Management in New Development & Redevelopment." *National Pollutant Discharge Elimination System (NPDES)*. <[http://cfpub1.epa.gov/npdes/stormwater/menuofbmps/post\\_8.cfm](http://cfpub1.epa.gov/npdes/stormwater/menuofbmps/post_8.cfm)>
- United States Environmental Protection Agency (USEPA). *Storm Water Technology Fact Sheet: Vegetated Swales* (EPA 832-F-99-006). 1999.
- Vermont Agency of Natural Resources. *The Vermont Stormwater Management Manual*. 2002.
- Virginia Stormwater Management Handbook, Volumes 1 and 2, First Edition, 1999



## BMP 6.4.9: Vegetated Filter Strip

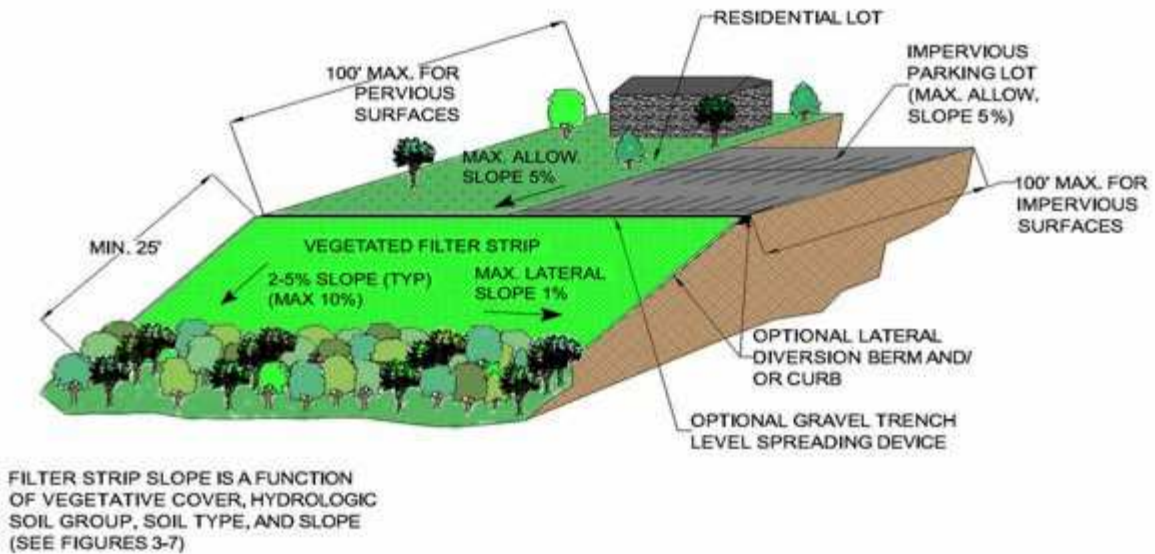
---

The EPA defines a Vegetated Filter Strip as a “permanent, maintained strip of planted or indigenous vegetation located between nonpoint sources of pollution and receiving water bodies for the purpose of removing or mitigating the effects of nonpoint source pollutants such as nutrients, pesticides, sediments, and suspended solids.”

<p style="text-align: center;"><b><u>Key Design Elements</u></b></p> <ul style="list-style-type: none"> <li>▪ Sheet Flow across Vegetated Filter Strip</li> <li>▪ Filter Strip length is a function of the slope, vegetative cover, and soil type.</li> <li>▪ Minimum recommended length of Filter Strip is 25 ft, however shorter lengths provide some water quality benefits as well.</li> <li>▪ Maximum Filter Strip slope is based on soil type and vegetated cover.</li> <li>▪ Filter strip slope should never exceed 8%. Slopes less than 5% are generally preferred.</li> <li>▪ Level spreading devices are recommended to provide uniform sheet flow conditions at the interface of the Filter Strip and the adjacent land cover.</li> <li>▪ Maximum contributing drainage area slope is generally less than 5%, unless energy dissipation is provided.</li> <li>▪ Minimum filter strip width should equal the width of the contributing drainage area.</li> <li>▪ Construction of filter strip should entail as little disturbance to existing vegetation at the site as possible.</li> <li>▪ See Appendix B for list of acceptable filter strip vegetation.</li> </ul>	<p style="text-align: center;"><b><u>Potential Applications</u></b></p> <p style="text-align: center;">Residential: Yes                  Commercial: Yes                  Ultra Urban: Limited                  Industrial: Limited                  Retrofit: Yes                  Highway/Road: Yes</p> <hr/> <p style="text-align: center;"><b><u>Stormwater Functions</u></b></p> <p style="text-align: center;">Volume Reduction: Low/Med.                  Recharge: Low/Med.                  Peak Rate Control: Low                  Water Quality: High</p> <hr/> <p style="text-align: center;"><b><u>Water Quality Functions</u></b></p> <p style="text-align: center;">TSS: 30%                  TP: 20%                  NO3: 10%</p>
--	--

**Other Considerations**

- Regular maintenance required for continued performance



## Description

Filter strips are gently sloping, densely vegetated areas that filter, slow, and infiltrate sheet flowing stormwater. Filter strips are best utilized to treat runoff from roads and highways, roof downspouts, small parking lots, and pervious surfaces. In highly impervious areas, they are generally not recommended as “stand alone” features, but as pretreatment systems for other BMPs, such as Infiltration Trenches or Bioretention Areas. Filter Strips are primarily designed to reduced TSS levels, however pollutant levels of hydrocarbons, heavy metals, and nutrients may also be reduced. Pollutant removal mechanisms include sedimentation, filtration, absorption, infiltration, biological uptake, and microbial activity. Depending on hydrologic soil group, vegetative cover type, slope, and length, a filter strip can allow for a modest reduction in runoff volume through infiltration.

The vegetation for Filter Strips may be comprised of:

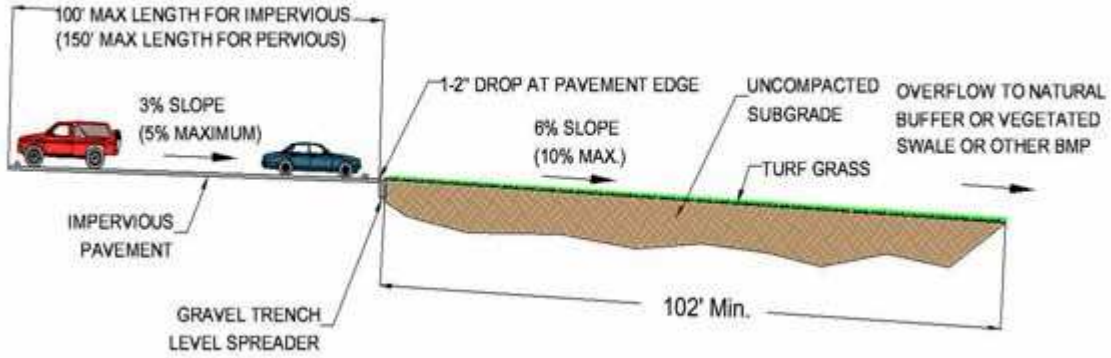
- Turf Grasses
- Meadow grasses, shrubs, and native vegetation, including trees
- Indigenous areas of woods and vegetation.

Filter strips may be comprised of a variety of trees, shrubs, and native vegetation to add aesthetic value as well as water quality benefits. The use of turf grasses will increase the required length of the filter strip, as compared to other vegetation options. The use of indigenous vegetated areas that have surface features that disperse runoff is encouraged, as the use of these areas will also reduce overall site disturbance and soil compaction. Runoff must be distributed so that erosive conditions cannot develop.

The vegetation in Filter Strips must be dense and healthy. Indigenous wooded areas should have a healthy layer of leaf mulch or duff. Indigenous areas that have surface features that concentrate flow are not acceptable.

The following example shows three filter strips that vary only by cover type. Each strip is on type 'C' soils and has a slope of 6%. Using the recommended sizing approach, the filter strip covered with turf grass required a length of 100 ft, while the strip with indigenous woods required only 50 ft. The strip covered with native grasses and some trees required 75 ft. Where the required length is not available, a filter strip can still be used but it will be less effective.

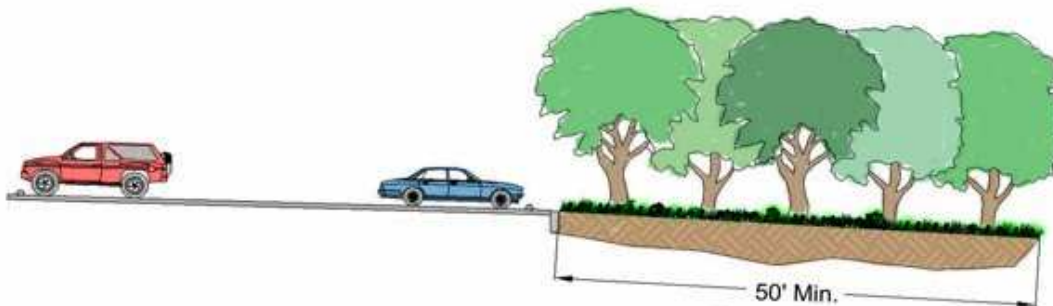
### Filter Strip Example #1: Turf Grass



### Filter Strip Example #2: Native Grasses and Planted Woods Grass



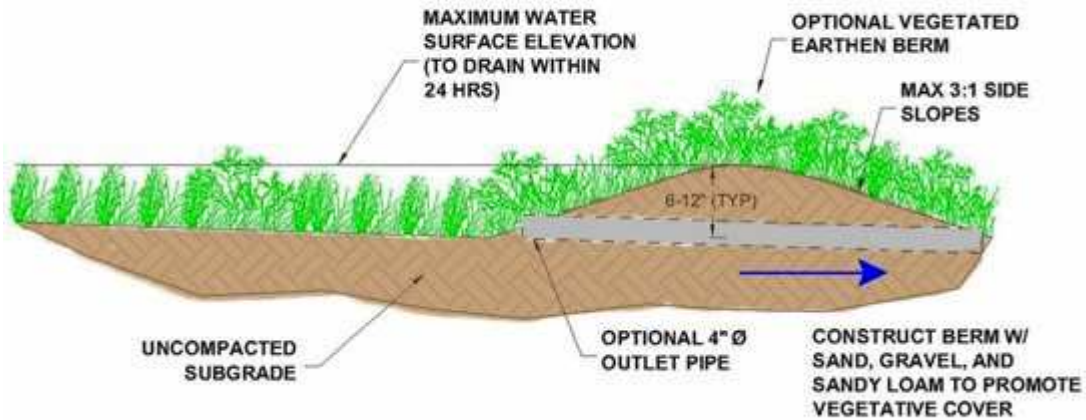
### Filter Strip Example #3: Indigenous Woods



## Variations

Filter strip effectiveness may be enhanced through the addition of a pervious berm at the toe of the slope. A pervious berm allows for greater runoff velocity and volume reduction and thus better pollutant removal ability, by providing a very shallow, temporarily ponded area. The berm should have a height of not more than six to twelve inches and be constructed of sand, gravel, and sandy loam to encourage vegetative cover. An outlet pipe(s) or overflow weir should be provided and sized to ensure that the area drains within 24 hours, or to convey larger storm events. The berm must be erosion resistant under the full range of storm events. Likewise, the ponded area should be planted with vegetation that is resistant to frequent inundation.

Check dams may be implemented on filter strips with slopes exceeding 5%. Check dams shall be constructed of durable, nontoxic materials such as rock, brick, wood, not more than six inches in height, and placed at appropriate intervals to encourage ponding and prevent erosion. Care must be taken to prevent erosion around the ends of the check dams.



## Applications

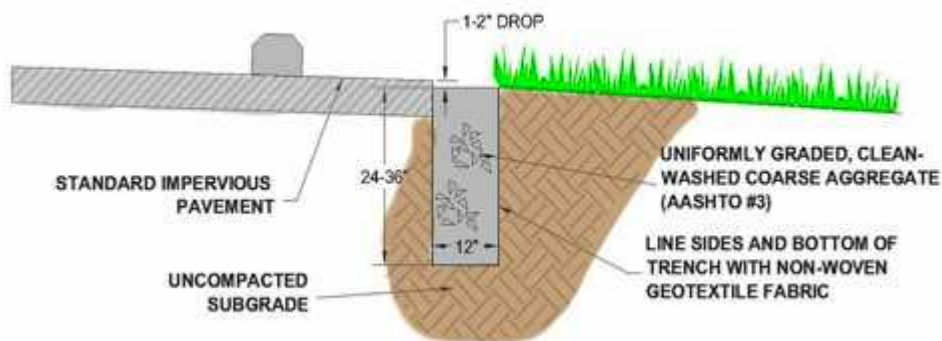
- Residential development lawn and housing areas
- Roads and highways
- Parking lots
- Pretreatment for other structural BMPs (Infiltration Trench, Bioretention, etc.)
- Commercial and light industrial facilities
- As part of a Riparian Buffer (located in Zone 3)

## Design Considerations

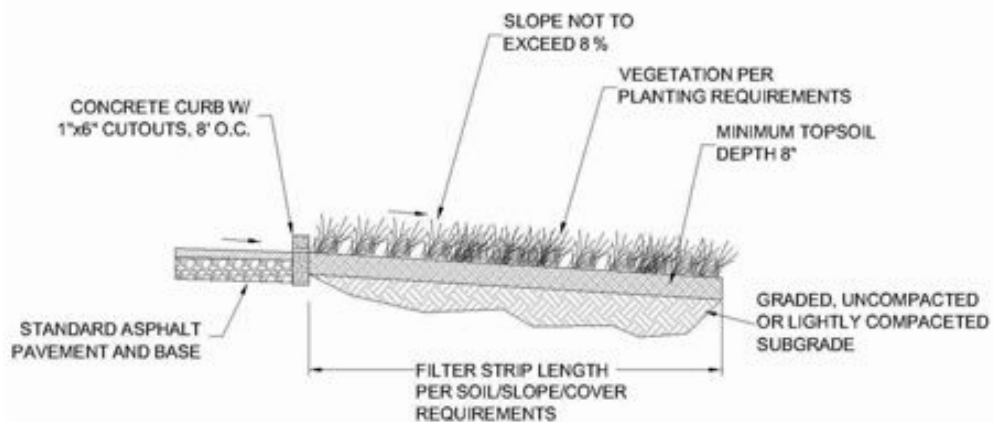
1. The design of vegetated filter strips is determined by site conditions (contributing drainage area, length, slope, etc.) site soil group, proposed cover type, and filter strip slope. The filter length can be determined from the appropriate graph shown below the text.

2. Level spreading devices or other measures may be required to provide uniform sheet flow conditions at the interface of the filter strip and the adjacent land cover. Concentrated flows are explicitly discouraged from entering filter strips, as they can lead to erosion and thus failure of the system. Examples of level spreader applications include:

- a. A gravel-filled trench, installed along the entire upgradient edge of the strip. The gravel in the trenches may range from pea gravel (ASTM D 448 size no. 6, 1/8" to 3/8") for most cases to shoulder ballast for roadways. Trenches are typically 12" wide, 24-36" deep, and lined with a nonwoven geotextile. When placed directly adjacent to an impervious surface, a drop (between the pavement edge and the trench) of 1-2" is recommended, in order to inhibit the formation of the initial deposition barrier.



- b. Curb stops



- c. Concrete sill (or lip)
- d. Slotted or depressed curbs
- e. An earthen berm with optional perforated pipe.

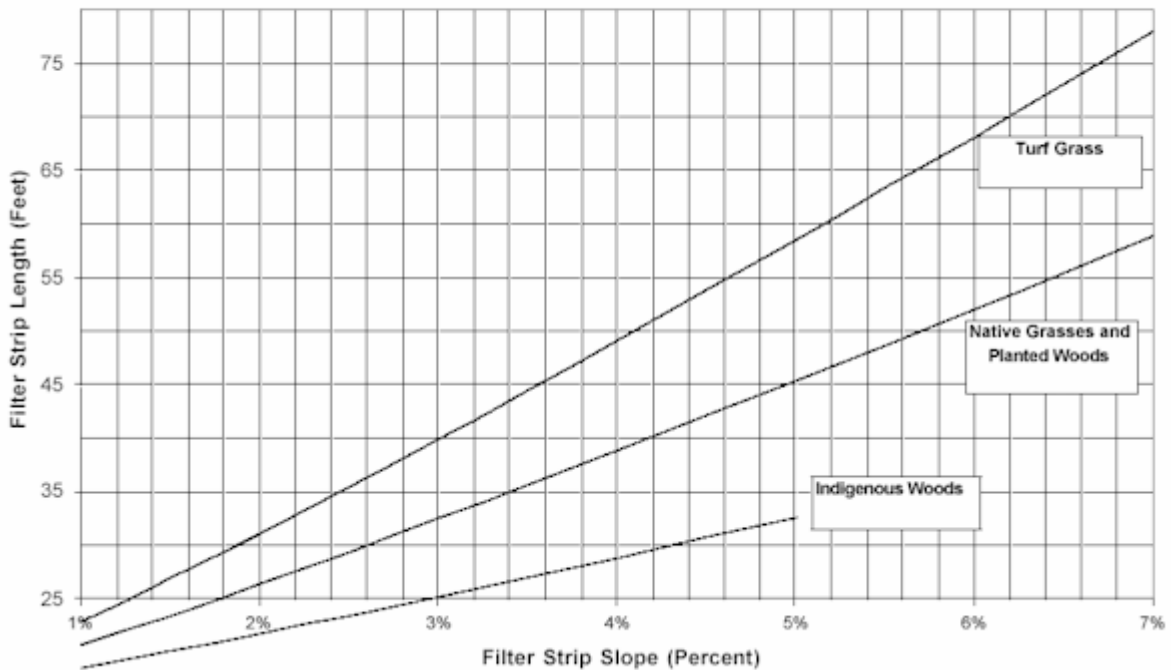
3. Although in some locations more “natural” spreader designs and materials, such as earthen berms, are desirable, they can be more susceptible to failure due to irregularities in berm elevation and density of vegetation. When it is desired to treat runoff from roofs or curbed impervious areas, a more structural approach, such as a gravel trench, is required. In this case, runoff shall be directly conveyed, via pipe from downspout or inlet, into the subsurface gravel and uniformly distributed by a perforated pipe along the trench bottom.
4. The upstream edge of a filter strip should be level and directly abut the contributing drainage area.
5. The seasonal high water table should be at least 2 to 4 ft lower than any point along the filter strip.
6. In areas where the soil infiltration rate has been compromised (e.g. by excessive compaction), the filter strip shall be tilled prior to establishment of vegetation. However, tilling will only have an effect on the top 12-18 inches of the soil layer. Therefore, other measures, such as planting trees and shrubs, may be needed to provide deeper aeration. Deep root penetration will promote greater absorptive capacity of the soil.
7. The ratio of contributing drainage area to filter strip area should not exceed 6:1.
8. The filter strip area should be densely vegetated with a mix of salt- and drought- tolerant and erosion-resistant plant species. Filter strip vegetation, whether planted or indigenous, may range from turf and native grasses to herbaceous and woody vegetation. The optimal vegetation strategy consists of plants with dense growth patterns, a fibrous root system for stability, good regrowth ability (following dormancy and cutting), and adaptability to local soil and climatic conditions. Native vegetation is always preferred. (See Appendix B for vegetation recommendations.)
9. Natural areas, such as forests and meadows, should not be unduly disturbed by the creation of a filter strip. If these areas are not already functional as natural filters, they may be enhanced by restorative methods or construction of a level spreader.
10. Maximum lateral slope of filter strip is 1%.
11. To prohibit runoff from laterally bypassing a strip, berms and/or curbs can be installed along the sides of the strip, parallel to the direction of flow.
12. Pedestrian and/or vehicular traffic on filter strips should be strictly discouraged. Since the function of filter strips can be easily overlooked or forgotten over time, a highly visible, physical “barrier” is suggested. This can be accomplished, at the discretion of the owner, by simple post and chain, signage, or even the level-spreading device itself.
13. Vegetated filter strips may be designed to discharge to a variety of features, including natural buffer areas, vegetated swales, infiltration basins, or other structural BMPs.
14. In cold climates, the following recommendations should be considered:
  - a. Filter strips often make convenient areas for snow storage. Thus, filter strip vegetation should be salt-tolerant and the maintenance schedule should involve removal of sand buildup at the toe of the slope.

- b. The bottom of the gravel trench (if used as the level spreader) should be placed below the frost line to prohibit water from freezing in the trench. The perforated pipe in the trench should be at least 8 inches in diameter to further discourage freezing.
- c. Other water quality options may be explored to provide backup to filter strips during the winter, when their pollutant removal ability is reduced.

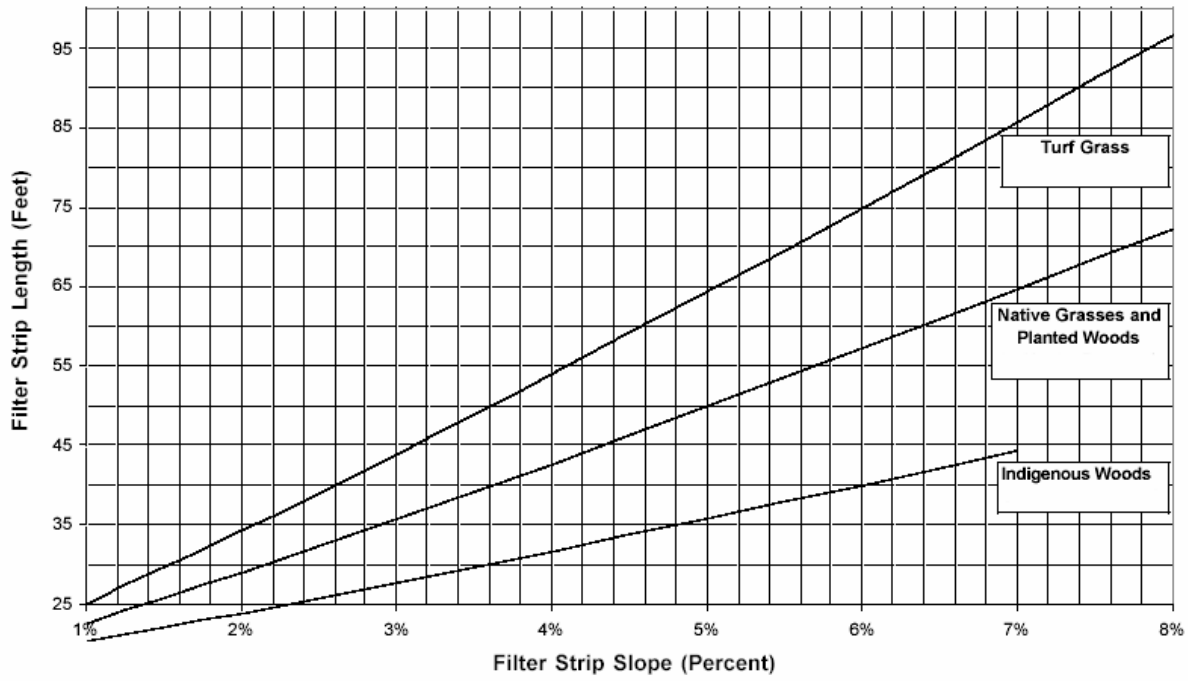
**Required Length as a Function of Slope, Soil Cover**

Filter Strip Soil Type	Hydrologic Soil Group	Maximum Filter Strip Slope (Percent)	
		Turf Grass, Native Grasses and Meadows	Planted and Indigenous Woods
Sand	A	7	5
Sandy Loam	B	8	7
Loam, Silt Loam	B	8	8
Sandy Clay Loam	C	8	8
Clay Loam, Silty Clay, Clay	D	8	8

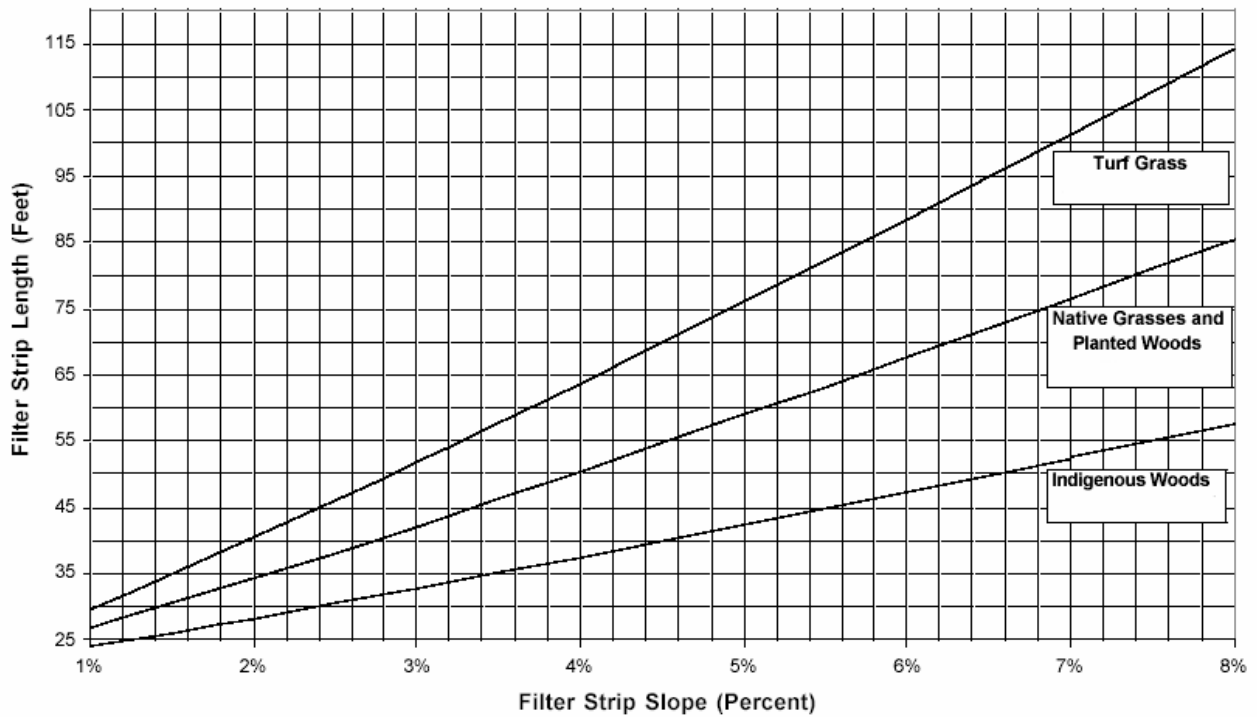
Drainage Area Soil: Sand HSG: A



Drainage Area Soil: Sandy Loam HSG: B

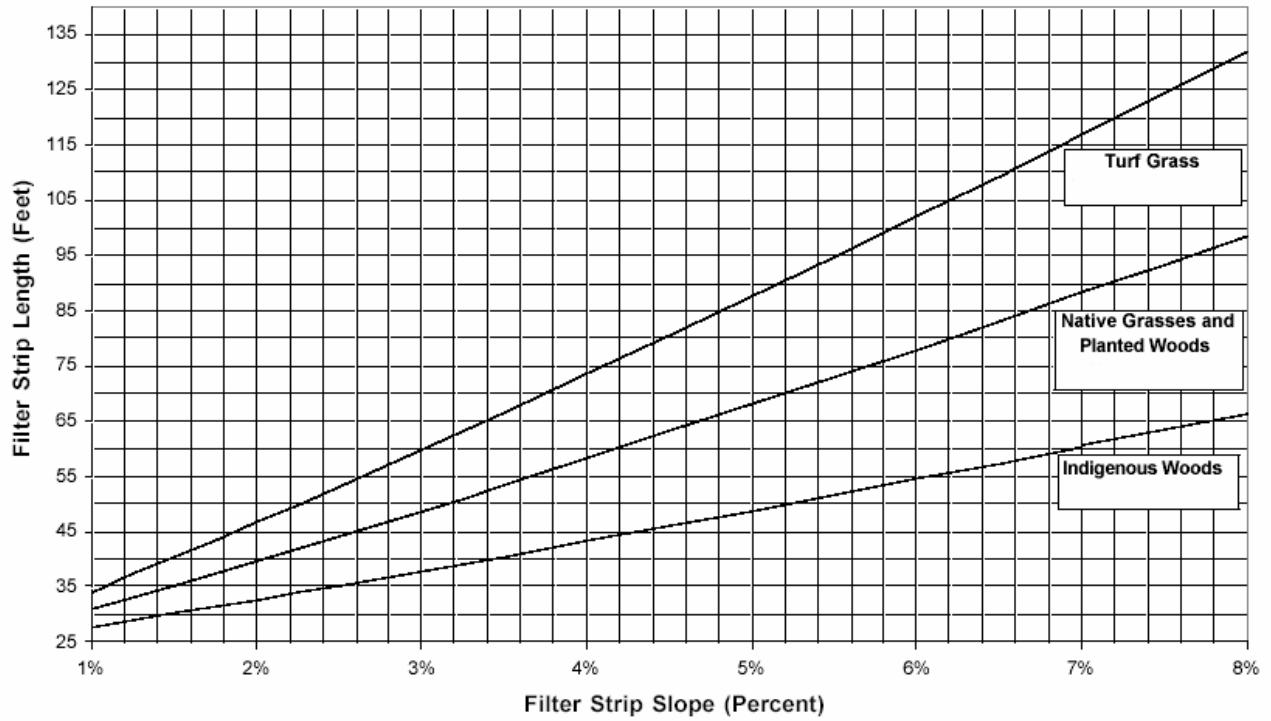


Drainage Area Soil: Loam, Silt Loam HSG: B

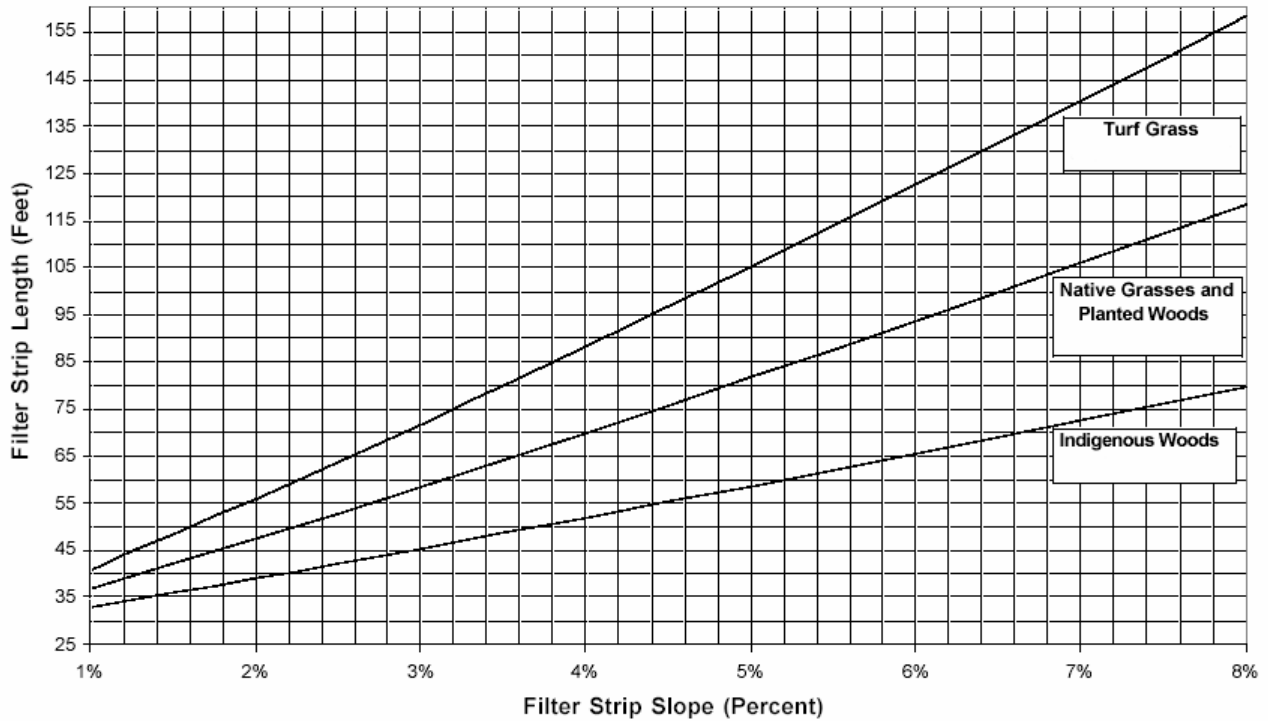




Drainage Area Soil: Sandy Clay Loam HSG: C



Drainage Area Soil: Clay Loam, Silty Clay, Clay HSG: D



## Detailed Stormwater Functions

### Volume Reduction Calculations

To determine the volume reduction over the length of a filter strip the following equation is recommended:

Filter Strip Volume Reduction = Filter Strip Area x Infiltration Rate x Storm Duration

When a berm is positioned at the toe of the slope, the total volume reduction shall be defined as the amount calculated above plus the following:

Berm Storage Volume = (Cross-sectional Area Behind Berm x Length of Berm) + (Surface Area Behind Berm x Infiltration Rate x 12 hours)

The inundated area behind the berm should be designed to drain within 24 hours. An outlet pipe or overflow weir may be needed to provide adequate drain down. In that case, the infiltration volume behind the berm should be adjusted based on the invert of the overflow mechanism.

### Peak Rate Mitigation Calculations

See in Section 8 for Peak Rate Mitigation methodology which addresses link between volume reduction and peak rate control.

### Water Quality Improvement

See in Section 8 for Water Quality Improvement methodology which addresses pollutant removal effectiveness of this BMP.

## Construction Sequence

1. Begin filter strip construction only when the upgradient site has been sufficiently stabilized and temporary erosion and sediment control measures are in place. (Erosion and sediment control methods shall adhere to the Pennsylvania Department of Environmental Protection's Erosion and Sediment Pollution Control Program Manual, March 2000 or latest edition.) The strip should be installed at a time of the year when successful establishment without irrigation is most likely. However, temporary irrigation may be needed in periods of little rain or drought.
2. For planted (not indigenous Filter Strips) clear and grub site as needed. Care should be taken to disturb as little existing vegetation as possible, whether in the designated filter strip area or in adjacent areas, and to avoid soil compaction. Grading a level slope may require removal of existing vegetation.
3. Rough grade the filter strip area, including the berm at the toe of the slope, if proposed. Use the lightest, least disruptive equipment to avoid excessive compaction and/or land disturbance.
4. Construct level spreader device at the upgradient edge of the strip. For gravel trenches, do not compact subgrade (Follow construction sequence for Infiltration Trench).
5. Fine grade the filter strip area. Accurate grading is crucial for filter strips. Even the smallest irregularities may compromise sheet flow conditions.

6. Seed or sod, as desired. Plant more substantial vegetation, such as trees and shrubs, if proposed. If sod is proposed, place tiles tightly enough to avoid gaps and stagger the ends to prevent channelization along the strip. Use a roller on sod to prevent air pockets between the sod and soil from forming.
7. Concurrent with #6, stabilize seeded filter strips with appropriate permanent soil stabilization methods, such as erosion control matting or blankets. Erosion control for seeded filter strips should be maintained for at least the first 75 days following the first storm event of the season.
8. Once the filter strip is sufficiently stabilized, remove temporary erosion and sediment controls. It is very important that filter strip vegetation be fully established before receiving upland stormwater flow. One full growing season is the recommended minimum time for establishment. Some seed mixtures may require a longer time period to become established.
9. Follow maintenance guidelines, as discussed below.

Note: When and if a filter strip is used for temporary sediment control, it might need to be regraded and reseeded immediately after construction and stabilization has occurred.

## Maintenance Issues

As with other vegetated BMPs, filter strips should be properly maintained to ensure their effectiveness. In particular, it is critical that sheet flow conditions and infiltration are sustained throughout the life of the filter strip. Field observations of strips in more urban settings show that their effectiveness can deteriorate due to lack of maintenance, inadequate design/location, and poor vegetative cover. Compared with other vegetated BMPs, filter strips require only minimal maintenance efforts, many of which may overlap with standard landscaping demands.

Vegetated filter strip components that receive or trap sediment and debris should be inspected for clogging, density of vegetation, damage by foot or vehicular traffic, excessive accumulations, and channelization. Inspections should be made on a quarterly basis for the first two years following installation, and then on a biannual basis thereafter. Inspections should also be made after every storm event greater than 1 in during the establishment period. Guidance information, usually in written manual form, for operating and maintaining filter strips should be provided to all facility owners and tenants. Facility owners are encouraged to keep an inspection log, where they can record all inspection dates, observations, and maintenance activities.

Sediment and debris should be routinely removed (but never less than biannually), or upon observation, when buildup exceeds 2 inches in depth in either the strip itself or the level spreader. If erosion is observed, measures should be taken to improve the level spreader or other dispersion method to address the source of erosion. Rills and gullies observed along the strip may be filled with topsoil, stabilized with erosion control matting, and either seeded or sodded, as desired. For channels less than 12 inches wide, filling with crushed gravel, which allows grass to creep in over time, is acceptable. For wider channels, i.e. greater than 12 inches, regrading and reseeding may be necessary. (Small bare areas may only require overseeding.) Regrading may also be required when pools of standing water are observed along the slope. (In no case should standing water be tolerated for longer than 48-72 hours.) If check dams are proposed, they should be inspected for cracks, rot, structural damage, obstructions, or any other factors that cause altered flow patterns or channelization. Inlets or sediment sumps that drain to filter strips should be cleaned periodically or as needed.

Sediment should be removed when the filter strip is thoroughly dry. Trash and debris removed from the site should be deposited only at suitable disposal/recycling sites and must comply with applicable local, state, and federal waste regulations. In the case where a filter strip is used for sediment control, it should be regraded and reseeded immediately after construction has concluded.

Maintaining a vigorous vegetative cover on a filter strip is critical for maximizing pollutant removal efficiency and erosion prevention. Grass cover should be mowed, with low ground pressure equipment, as needed to maintain a height of 4-6 inches. Mowing should be done only when the soil is dry, in order to prevent tracking damage to vegetation, soil compaction, and flow concentrations. Generally speaking, grasses should be allowed to grow as high as possible, but mowed frequently enough to avoid troublesome insects or noxious weeds. Fall mowing should be controlled to a grass height of 6 inches, to provide adequate wildlife winter habitat. When and where cutting is desired for aesthetic reasons, a high blade setting should be used.

If vegetative cover is not fully established within the designated time, it should be replaced with an alternative species. It is standard practice to contractually require the contractor to replace dead vegetation. Unwanted or invasive growth should be removed on an annual basis. Biweekly inspections are recommended for at least the first growing season, or until the vegetation is permanently established. Once the vegetation is established, inspections of health, diversity, and density should be performed at least twice per year, during both the growing and non-growing season. Vegetative cover should be sustained at 85% and reestablished if damage greater than 50% is observed. Whenever possible, deficiencies in vegetation are to be mollified without the use of fertilizers or pesticides. These treatment options, as well as any other methods used to achieve optimum vegetative health, should only be used under special circumstances and if they do not compromise the functionality of the filter strip.

Two other maintenance recommendations involve soil aeration and drain down time. If a filter strip exhibits signs of poor drainage and/or vegetative cover, periodic soil aeration may be needed. In addition, depending on soil characteristics, the strip may need periodic liming. The design and maintenance plan of filter strips, especially those with flow obstructions should specify the approximate time it would take for the system to "drain down" the maximum design storm runoff volume. Post-rainfall inspections should include evaluations of the filter's actual drain down time compared to the specified time. If significant differences (either increase or decrease) are observed, or if the 72 hour maximum time is exceeded, strip characteristics such as soils, vegetation, and groundwater levels should be reevaluated. Measures should be taken to establish, or reestablish as the case may be, the specified drain down time of the system.

## Cost Issues

The real cost of filter strips is the land they require. When unused land is readily available at a site, filter strips may prove a sensible and cost-effective approach. However, where land costs are at a premium (i.e. not readily available), this practice may prove cost-prohibitive in the end. The cost of establishing a filter strip itself is relatively minor. Of course, the cost is even less when an existing grass or meadow area is identified as a possible filter strip area before development begins.

The cost of filter strips includes grading, sodding (when applicable), installation of vegetation (trees, shrubs, etc.), the construction of a level spreader, and the construction of a pervious berm, if proposed. Depending on whether seed or sod is applied, not to mention enhanced vegetation use or design variations, construction costs may range anywhere from \$0 (assuming the area was to be grassed regardless of use as treatment) to \$50,000 per acre. The annual cost of maintaining filter strips

(mowing, weeding, inspection, litter removal, etc.) generally runs from \$100 to \$1400 per acre and in fact, may overlap with standard landscape maintenance costs. Maintenance costs are highly variable, as they are a function of frequency and local labor rates.

### Specifications

The following specifications are provided for information purposes only. These specifications include information on acceptable materials for typical applications, but are by no means exclusive or limiting. The designer is responsible for developing detailed specifications for individual design projects in accordance with the project conditions.

1. **Vegetation** – See Appendix B
2. **Erosion and Sediment** Control components shall conform to the Pennsylvania Department of Environmental Protection’s Erosion and Sediment Pollution Control Program Manual, March 2000 or latest edition.

For a gravel trench level spreader:

3. **Pipe** should be continuously perforated, smooth interior, high-density polyethylene (HDPE) with a minimum inside diameter of 8-inches. The pipe should meet AASHTO M252, Type S or AASHTO M294, Type S.
4. **Stone** for infiltration trenches should be 2-inch to 1-inch uniformly graded coarse aggregate, with a wash loss of no more than 0.5%, AASHTO size number 3 per AASHTO Specifications, Part I, 19th Ed., 1998, or later and should have voids  $\geq 35\%$  as measured by ASTM-C29.

Pea gravel (clean bank-run gravel) may also be used. Pea gravel should meet ASTM D 448 and be sized as per No.6 or 1/8” to 3/8”.

5. **Non-Woven Geotextile** should consist of needled non-woven polypropylene fibers and meet the following properties:
 

a. Grab Tensile Strength (ASTM-D4632)	$\geq$	120 lbs
b. Mullen Burst Strength (ASTM-D3786)	$\geq$	225 psi
c. Flow Rate (ASTM-D4491)	$\geq$	95 gal/min/ft <sup>2</sup>
d. UV Resistance after 500 hrs (ASTM-D4355)	$\geq$	70%
e. Heat-set or heat-calendared fabrics are not permitted		

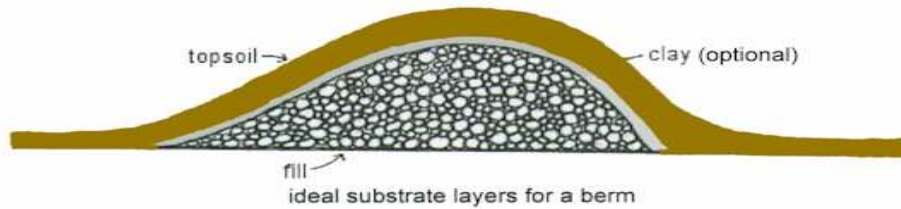
Acceptable types include Mirafi 140N, Amoco 4547, and Geotex 451.
6. **Check dams** constructed of natural wood should be 6 in to 12 in inches diameter and notched as necessary. The following species are acceptable: Black Locust, Red Mulberry, Cedars, Catalpa, White Oak, Chestnut Oak, Black Walnut. The following species are not acceptable since they can rot over time: Ash, Beech, Birch, Elm, Hackberry, Hemlock, Hickories, Maples, Red and Black Oak, Pines, Poplar, Spruce, Sweetgum, and Willow. An earthen check dam should be constructed of sand, gravel, and sandy loam to encourage grass cover. (Sand: ASTM C-33 fine aggregate concrete sand 0.02 in to 0.04 in, Gravel: AASHTO M-43 0.5 in to 1.0 in). A stone check dam should be constructed of R-4 rip rap, or equivalent.

7. **Pervious Berms** The berm should have a height of 6-12 in and be constructed of sand, gravel, and sandy loam to encourage grass cover. (Sand: ASTM C-33 fine aggregate concrete sand 0.02"-0.04", Gravel: AASHTO M-43 ½" to 1")

## References

- New Jersey Department of Environmental Protection. *New Jersey Stormwater BMP Manual*. 2004
- Environmental Services, City of Portland. *Stormwater Management Manual*. September 2002.
- Virginia BMP Manual
- Atlanta Regional Commission. *Georgia Stormwater Management Manual*. August 2001.
- Delaware Department of Natural Resources. *DURMM: The Delaware Urban Runoff Management Model*. (March 2001)
- The Vermont Agency of Natural Resources. *The Vermont Stormwater Management Manual*. April 2002.
- California Stormwater Quality Association. *California Stormwater BMP Handbook*. January 2003.
- Washington State Department of Ecology, 2002. *Stormwater Management Manual for Western Washington*, Olympia, WA
- South Florida Water Management District, 2002. *Best Management Practices for Southern Florida Urban Stormwater Management Systems*, West Palm Beach, FL
- United States Environmental Protection Agency (USEPA), 1999. *Storm Water Technology Fact Sheet: Sand Filters* (EPA 832-F-99-007)
- Auckland Regional Council, 2003. *Stormwater Management Devices: Design Guidelines Manual*, Auckland, New Zealand
- Center for Watershed Protection and Maryland Department of the Environment, 2000. *2000 Maryland Stormwater Design Manual*, Baltimore, MD
- Ontario Ministry of the Environment, 2003. *Stormwater Management Planning and Design Manual 2003*, Toronto, Ontario
- Barr Engineering Company, 2001. *Minnesota Urban Small Sites BMP Manual: Stormwater Best Management Practices for Cold Climates*, St. Paul, MN.
- CRWR Online Report 97-5: Use of Vegetative Controls For Treatment of Highway Runoff (University of Texas at Austin)

## BMP 6.4.10: Infiltration Berm & Retentive Grading



An Infiltration Berm is a mound of compacted earth with sloping sides that is usually located along a contour on relatively gently sloping sites. Berms can also be created through excavation/removal of upslope material, effectively creating a Berm with the original grade. Berms may serve various stormwater drainage functions including: creating a barrier to flow, retaining flow and allowing infiltration for volume control, and directing flows. Grading may be designed in some cases to prevent rather than promote stormwater flows, through creation of "saucers" or "lips" in site yard areas where temporary retention of stormwater does not interfere with use.

<p style="text-align: center;"><b><u>Key Design Elements</u></b></p> <ul style="list-style-type: none"> <li>▪ Maintain a minimum 2-foot separation to bedrock and seasonally high water table, provide distributed infiltration area (5:1 impervious area to infiltration area - maximum), site on natural, uncompacted soils with acceptable infiltration capacity, and follow other guidelines described in Protocol 2: Infiltration Systems Guidelines</li> <li>▪ Berms should be relatively low, preferably no more than 24 inches in height.</li> <li>▪ If berms are to be mowed, the berm side slopes should not exceed a ratio of 4:1 to avoid "scalping" by mower blades.</li> <li>▪ The crest of the berm should be located near one edge of the berm, rather than in the middle, to allow for a more natural, asymmetrical shape.</li> <li>▪ Berms should be vegetated with turf grass at a minimum, however more substantial plantings such as meadow vegetation, shrubs and trees are recommended.</li> </ul>	<p style="text-align: center;"><b><u>Potential Applications</u></b></p> <p>Residential: Yes                  Commercial: Yes                  Ultra Urban: Limited                  Industrial: Yes                  Retrofit: Yes                  Highway/Road: Yes</p>
	<p style="text-align: center;"><b><u>Stormwater Functions</u></b></p> <p>Volume Reduction: Low/Med.                  Recharge: Low                  Peak Rate Control: Medium                  Water Quality: Med./High</p>
	<p style="text-align: center;"><b><u>Water Quality Functions</u></b></p> <p>TSS: 60%                  TP: 50%                  NO3: 40%</p>

### **Other Considerations**

- **Protocol 1. Site Evaluation and Soil Infiltration Testing** and **Protocol 2. Infiltration Systems Guidelines** should be followed, see Appendix C

## Description

Infiltration Berms are linear landscape features located along (i.e. parallel to) existing site contours in a moderately sloping area. They can be described as built-up earthen embankments with sloping sides, which function to divert, retain and promote infiltration, slow down, or divert stormwater flows. Berms are also utilized for reasons independent of stormwater management, such as to add interest to a flat landscape, create a noise or wind barrier, separate land uses, screen undesirable views or to enhance or emphasize landscape designs. Berms are often used in conjunction with recreational features, such as pathways through woodlands. Therefore, when used for stormwater management, berms and other retentive grading techniques can serve multifunctional purposes and are easily incorporated into the landscape.

Infiltration Berms create shallow depressions that collect and temporarily store stormwater runoff, allowing it to infiltrate into the ground and recharge groundwater. Infiltration berms may be constructed in series along a gradually sloping area.

1. Infiltration berms can be constructed on disturbed slopes and revegetated as part of the construction process. Infiltration berms should not be installed on slopes where soils having low shear strength (or identified as “slip prone” or “landslide prone”, etc.) have been mapped.
2. They can be installed along the contours within an existing woodland area to slow and infiltrate runoff from a development site.
3. May be constructed in combination with a subsurface infiltration trench at the base of the berm.

Infiltration Berms can provide runoff rate and volume control, though the level to which they do is limited by a variety of factors, including design variations (height, length, etc.), soil permeability rates, vegetative cover, and slope. Berms are ideal for mitigating runoff from relatively small impervious areas with limited adjacent open space (e.g. roads, small parking lots). Systems of parallel berms have been used to intercept stormwater from roadways or sloping terrain. Berms can sometimes be threaded carefully along contour on wooded hillsides, minimally disturbing existing vegetation and yet still gaining stormwater management credit from the existing woodland used. Conversely, berms are often incapable of controlling runoff from very large, highly impervious sites. Due to their relatively limited volume capacity, the length and/or number of berms required to retain large quantities of runoff make them impractical as the lone BMP in these cases. In these situations, berms are more appropriately used as pre- or additional-treatment for other more distributed infiltration systems closer to the source of runoff (i.e. porous pavement with subsurface infiltration).

Retentive grading may be employed in portions of sites where infiltration has been deemed to be possible and where site uses are compatible. Ideally, such retentive grading will serve to create subtle “saucers,” which contain and infiltrate stormwater flows. The “lip” of such saucers effectively function as a very subtle berm, which can be vertically impervious when vegetated and integrated into the overall landscape.



## Variations

### Diversion Berms

Diversion Berms can be used to protect slopes from erosion and to slow runoff rate. They can also be used to direct stormwater flow in order to promote longer flow pathways, thus increasing the time of concentration. Diversion berms often:

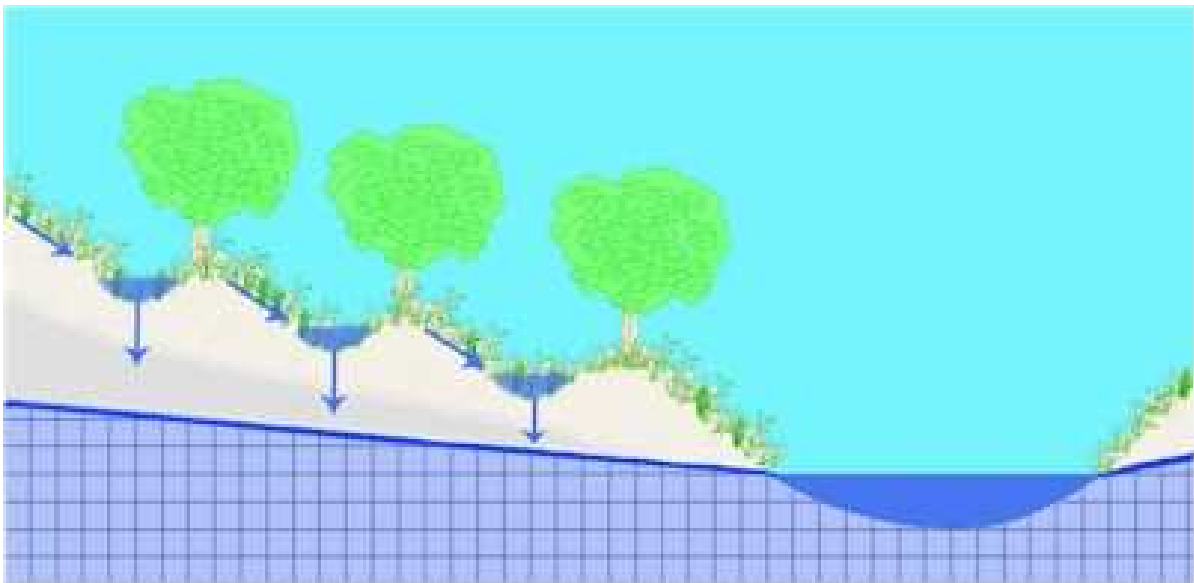
1. Consist of compacted earth ridges usually constructed across a slope in series to intercept runoff.
2. Can be incorporated within other stormwater BMPs to increase travel time of stormwater flow by creating natural meanders while providing greater opportunity for pollutant removal and infiltration.



## Applications

- **Meadow/Woodland Infiltration Berms**  
 Infiltration Berms effectively control both the rate and volume of stormwater runoff. The berms are constructed along the contours and serve to collect and retain stormwater runoff, allowing it to infiltrate through the soil mantle and recharge the groundwater. Depressed areas adjacent to the berms should be level so that concentrated flow paths are not encouraged. Infiltration berms may have a variety of vegetative covers but meadow and woodland are recommended in order to reduce maintenance. If turf grass is used, berms in series should be constructed with enough space between them to allow access for maintenance vehicles. Also, berm side slopes should not exceed a 4:1 ratio. Woodland infiltration berms can sometimes be installed within existing wooded areas for additional stormwater management. Berms in wooded areas can even improve the health of existing vegetation, through enhanced groundwater recharge. Care should be taken during construction to ensure minimum disturbance to existing vegetation, especially tree roots.

- **Slope Protection**  
 Diversion Berms can be used to help protect steeply sloping areas from erosion. Berms may divert concentrated discharge from a developed area away from the sloped area. Additionally, berms may be installed in series down the slope to retain flow and spread it out along multiple level berms to discourage concentrated flow.
  
- **Flow Pathway Creation**  
 Berms may be utilized to create or enhance stormwater flow pathways within existing or proposed BMPs, or as part of an LID (Low Impact Development) strategy. Berms can be installed such that vegetated stormwater flow pathways are allowed to “meander” so that stormwater travel time is increased. For example, berms can be utilized within existing BMPs as part of a retrofit strategy to eliminate short-circuited inlet/outlet situations within detention basins provided care is taken to ensure the required storage capacity of the basin is maintained. Flow pathway creation can be utilized as part of an LID strategy to disconnect roof leaders and attenuate runoff, while increasing pervious flow pathways within developed areas. Berms should be designed to compliment the landscape while diverting runoff across vegetated areas and allowing for longer travel times to encourage pollutant removal and infiltration.
  
- **Constructed Wetland Berms**  
 Berms are often utilized within constructed wetland systems in order to create elongated flow pathways with a variety of water depths. See BMP 6.6.1 – Constructed Wetlands.



**Design Considerations**

1. Sizing criteria are dependent on berm function, location and storage volume requirements.
  - a. Low **berm height** (less than or equal to 24 inches) is recommended to encourage maximum infiltration and to prevent excessive ponding behind the berm. Greater heights may be used where berms are being used to divert flow or to create “meandering” or lengthened flow pathways. In these cases, stormwater is designed to flow adjacent to (parallel to), rather than over the crest of the berm. Generally, more berms of smaller size are preferable to fewer berms of large size.

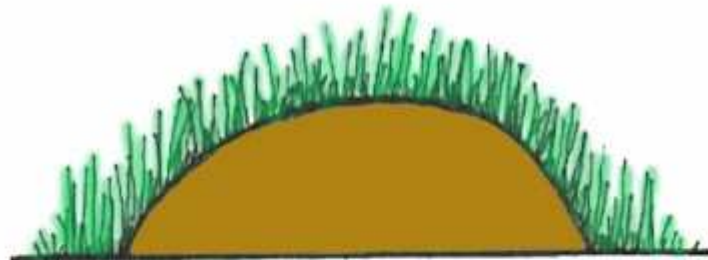
b. **Berm length** is dependent on functional need and site size. Berms installed along the contours should be level and located across the slope. Maximum length will depend on width of the slope. Generally speaking, diversion berm length will vary with the size and constraints of the site in question.

2. **Infiltration Berms** should be constructed along (parallel to) contours at a constant elevation.
3. **Soil.** A berm may consist entirely of high quality topsoil. To reduce cost, only the top foot needs to consist of high quality Topsoil, with well-drained soil making up the remainder of the berm. The use of gravel is not recommended in the layers directly underneath the topsoil because of the tendency of the soil to wash through the gravel. In some cases, the use of clay may be required due to its cohesive qualities (especially where the berm height is high or relatively steeply sloped). However, well-compacted soil usually is sufficient provided that the angle of repose (see below) is not exceeded for the soil medium used.

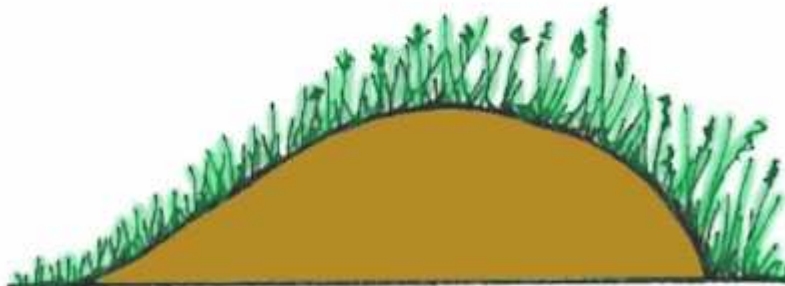
A more sustainable alternative to importing berm soil from off-site is to balance berm cut and fill material as much as possible, provided on-site soil is deemed suitable as per the Specifications below. Ideally, the concave segment (infiltration area) of the berm is excavated to a maximum depth of 12 inches and then used to construct the convex segment (crest of berm).

4. The **Angle of Repose of Soil** is the angle at which the soil will rest and not be subject to slope failure. The angle of repose of any soil will vary with the texture, water content, compaction, and vegetative cover. Typical angles of repose are given below:
  - a. Non-compacted clay: 5-20%
  - b. Dry Sand: 33%
  - c. Loam: 35-40%
  - d. Compacted clay: 50-80%
5. **Side Slopes.** The angle of repose for the soil used in the berm should determine the maximum slope of the berm with additional consideration to aesthetic, drainage, and maintenance needs. If a berm is to be mowed, the slope should not exceed a 4:1 ratio (horizontal to vertical) in order to avoid “scalping” by mower blades. If trees are to be planted on berms, the slope should not exceed a 5:1 ratio. Other herbaceous plants, which do not require mowing, can tolerate slopes of 3:1. Berm side slopes should not exceed a 2:1 ratio.
6. **Plant Materials.** It is important to consider the function and form of the berm when selecting plant materials. If using trees, plant them in a pattern that appears natural and accentuates the berm’s form. Consider tree species appropriate to the proposed habitat. If turf will be combined with woody and herbaceous plants, the turf should be placed to allow for easy maneuverability while mowing. Low maintenance plantings, such as trees and meadow plants, rather than turf and formal landscaping, are encouraged.
7. **Infiltration Design.** Infiltration berms located along slopes should be composed of low berms (less than 12 inches high) and should be vegetated. Subsurface soils should be uncompacted to encourage infiltration behind the berms. Soil testing is not required where berms are located within an existing woodland, but soil maps/data should be consulted when siting the berms. Where feasible, surface soil testing should be conducted in order to estimate potential infiltration rates.

8. **Infiltration Trench Option.** Soil testing is recommended for infiltration berms that will utilize a subsurface infiltration trench. Infiltration trenches are not recommended in existing woodland areas as excavation and installation of subsurface trenches could damage tree root systems. See BMP 6.4.4 – Infiltration Trench, for information on infiltration trench design.
9. **Aesthetics.** To the extent possible, berms should reflect the surrounding landscape. Berms should be graded so that the top of the berm is smoothly convex and the toes of the berms are smoothly concave. Natural, asymmetrical berms are usually more effective and attractive than symmetrical berms. The crest of the berm should be located near one end of the berm rather than in the middle.



undesirable shape for a berm



desirable shape for a berm

## Detailed Stormwater Functions

### Infiltration Area

The Infiltration Area is the ponding area behind the berm, defined as:  
 Length of ponding x Width ponding area = Infiltration Area (Ponding Area)

### Volume Reduction Calculations

Storage volume can be calculated for Infiltration Berms. The storage volume is defined as the ponding area created behind the berm, beneath the discharge invert (i.e. the crest of the berm). Storage volume can be calculated differently depending on the variations utilized in the design.

Surface Storage Volume is defined as the volume of water stored on the surface at the ponding depth. This is equal to:

Cross-sectional area of ponded water x Berm length = Surface Storage Volume

### **Peak Rate Mitigation:**

See Section 8 for Peak Rate Mitigation methodology which addresses link between volume reduction and peak rate control.

### **Water Quality Improvement:**

See Section 8 for Water Quality Improvement methodology which addresses pollutant removal effectiveness of this BMP.

### **Construction Sequence**

The following is a typical construction sequence for a infiltration berm without a subsurface infiltration trench, though alterations will be necessary depending on design variations.

1. Install temporary sediment and erosion control BMPs as per the Pennsylvania Erosion and Sediment Pollution Control Program Manual.
2. Complete site grading and stabilize within the limit of disturbance except where Infiltration Berms will be constructed; make every effort to minimize berm footprint and necessary zone of disturbance (including both removal of existing vegetation and disturbance of empty soil) in order to maximize infiltration.
3. Lightly scarify the soil in the area of the proposed berm before delivering soil to site.
4. Bring in fill material to make up the major portion of the berm. Soil should be added in 8-inch lifts and compacted after each addition according to design specifications. The slope and shape of the berm should be graded out as soil is added.
5. Protect the surface ponding area at the base of the berm from compaction. If compaction of this area does occur, scarify soil to a depth of at least 8 inches.
6. Complete final grading of the berm after the top layer of soil is added. Tamp soil down lightly and smooth sides of the berm. The crest and base of the berm should be at level grade.
7. Plant berm with turf, meadow plants, shrubs or trees, as desired.
8. Mulch planted and disturbed areas with compost mulch to prevent erosion while plants become established.

## Maintenance Issues

Infiltration Berms have low to moderate maintenance requirements, depending on the design.

### Infiltration Berms

- Regularly inspect to ensure they are infiltrating; monitor drawdown time after major storm events
- Inspect any structural components, such as inlet structures to ensure proper functionality
- If planted in turf grass, maintain by mowing. Other vegetation will require less maintenance. Trees and shrubs may require annual mulching, while meadow planting requires annual mowing and clippings removal.
- Avoid running heavy equipment over the infiltration area at the base of the berms. The crest of the berm may be used as access for heavy equipment when necessary to limit disturbance.
- .
- Routinely remove accumulated trash and debris.
- Remove invasive plants as needed
- Inspect for signs of flow channelization; restore level gradient immediately after deficiencies are observed

### Diversion Berms

- Regularly inspect for erosion or other failures.
- Regularly inspect structural components to ensure functionality.
- Maintain turf grass and other vegetation by mowing and re-mulching.
- 
- Remove invasive plants as needed.
- Routinely remove accumulated trash and debris.

## Cost Issues

Infiltration berms can be less expensive than other BMPs options because extensive clearing and grubbing is not necessary. Cost will depend on height, length and width of berms as well as desired vegetation.

## Specifications

The following specifications are provided for information purposes only. These specifications include information on acceptable materials for typical applications, but are by no means exclusive or limiting. The designer is responsible for developing detailed specifications for individual design projects in accordance with the project conditions.

### 1. Soil Materials

- a. Satisfactory soil materials are defined as those complying with ASTM D2487 soil classification groups GW, GP, GM, SM, SW, and SP.
- b. Unsatisfactory soil materials are defined as those complying with ASTM D2487 soil classification groups GC, SC, ML, MH, CL, CH, OL, OH, and PT.
- c. Topsoil: Topsoil stripped and stockpiled on the site should be used for fine grading. Topsoil is defined as the top layer of earth on the site, which produces heavy growths of crops, grass or other vegetation.

- d. Soils excavated from on-site may be used for berm construction provided they are deemed satisfactory as per the above recommendations or by a soil scientist.

## **2. Placing and Compacting of Berm Area Soil**

- a. Ground Surface Preparation: Remove vegetation, debris, unsatisfactory soil materials, obstructions, and deleterious materials from ground surface prior to placement of fill. Plow strip, or break up sloped surfaces steeper than 1 vertical to 4 horizontal so that fill material will bond with existing surface.
- b. When existing ground surface has a density less than that specified under g. (below) for particular area classification, break up ground surface, pulverize, bring the moisture-condition to optimum moisture content, and compact to required depth and percentage of maximum density.
- c. Place backfill and fill materials in layers not more than 8 inches in loose depth for material to be compacted by heavy compaction equipment, and not more than 4 inches in loose depth for material to be compacted by hand-operated tampers.
- d. Before compaction, moisten or aerate each layer as necessary to provide optimum moisture content. Compact each layer to required percentage of maximum dry density or relative dry density for each area classification. Do not place backfill or fill material on surfaces that are muddy, frozen, or contain frost or ice.
- e. Place backfill and fill materials evenly adjacent to structures, piping, or conduit to required elevations. Prevent wedging action of backfill against structures or displacement of piping or same elevation in each lift.
- f. Control soil and fill compaction, providing minimum percentage of density specified for each area classification indicated below. Correct improperly compacted areas or lifts if soil density tests indicate inadequate compaction.
- g. Percentage of Maximum Density Requirements: Compact soil to not less than the following percentages of maximum density, in accordance with ASTM D 1557:
  - Under lawn or unpaved areas, compact top 6 inches of subgrade and each layer of backfill or fill material at 85 percent maximum density.
  - Under infiltration areas no compaction shall be permitted.

## **3. Grading**

- a. General: Uniformly grade areas within limits of grading under this section, including adjacent transition areas. Smooth finished surface within specified tolerances; compact with uniform levels or slopes between points where elevations are indicated or between such points and existing grades.
- b. Lawn or Unpaved Areas: Finish areas to receive topsoil to within not more than 0.10 foot above or below required subgrade elevations.
- c. Compaction: After grading, compact subgrade surfaces to the depth and indicated percentage of maximum or relative density for each area classification.

## **4. Temporary Seeding**

- a. Temporary seeding and mulching shall be required on all freshly graded areas immediately following earth moving procedures. Seed-free straw or salt hay mulch shall be applied at a rate of 75 lbs. per 1,000 square feet over temporary seeded areas. Straw bale barriers shall be placed in swale areas until vegetation is established.
- b. Should temporary seeding not be possible or not establish itself properly, mulch as described above, pending fine grading or permanent seeding.

## **5. Finish Grading**

- a. Spreading of topsoil and finish grading shall be coordinated with the work of the Landscape Contractor.
- b. Verify that the rough grades meet requirements for tolerances, materials, and compaction.
- c. Surface of subgrades shall be loosened and made friable by cross-discing or harrowing to a depth of 2 inches. Stones and debris more than 1-1.5 inches in any dimension shall be raked up and grade stakes and rubbish removed.
- d. Topsoil shall be uniformly spread to minimum depths after settlement of 6 inches on areas to be seeded and 4 inches on areas to be sodded. Correct any surface irregularities to prevent formation of low spots and pockets that would retain water.
- e. Topsoil shall not be placed when the subgrade is frozen, excessively wet, or extremely dry and no topsoil shall be handled when in a frozen or muddy condition. During all operations following topsoil spreading, the surface shall be kept free from stones over 1-1.5 inches in size or any rubbish, debris, or other foreign material.
- f. After placing topsoil rake soil to a smooth, even-draining surface and compact lightly with an empty water roller. Leave finish graded areas clean and well raked, ready for lawn work.

## References

AMEC Earth and Environmental Center for Watershed Protection et al. *Georgia Stormwater Management Manual*. 2001.

Harris, C. and Dines, N. *Time Saver Standards for Landscape Architecture, 2<sup>nd</sup> Edition*. New York, NY: McGraw-Hill, 1998.

University of Minnesota. "Building Soil Berms." *Sustainable Urban Landscape Information Series (SULIS)*. 1998. <[http://www.sustland.umn.edu/implement/soil\\_berms.html](http://www.sustland.umn.edu/implement/soil_berms.html)>

Chester County Conservation District. *Chester County Stormwater BMP Tour Guide-Infiltration Trenches (Infiltration Berms)*. 2002.

Williams, G.P. *Canadian Building Digest - Drainage and Erosion at Construction Sites*. National Research Council Canada. 2004. <<http://irc.nrc-cnrc.gc.ca/cbd/cbd183e.html>>



## **6.5 Volume/Peak Rate Reduction BMPs**



## BMP 6.5.1: Vegetated Roof



An extensive vegetated roof cover is a veneer of vegetation that is grown on and completely covers an otherwise conventional flat or pitched roof ( $\leq 30^\circ$  slope), endowing the roof with hydrologic characteristics that more closely match surface vegetation than the roof. The overall thickness of the veneer may range from 2 to 6 inches and may contain multiple layers, consisting of waterproofing, synthetic insulation, non-soil engineered growth media, fabrics, and synthetic components. Vegetated roof covers can be optimized to achieve water quantity and water quality benefits. Through the appropriate selection of materials, even thin vegetated covers can provide significant rainfall retention and detention functions.

<p style="text-align: center;"><b><u>Key Design Elements</u></b></p> <ul style="list-style-type: none"> <li>▪ 2-6 inches of engineered media; assemblies that are 4 inches and deeper may include more than one type of engineered media</li> <li>▪ Engineered media should have a high mineral content. Engineered media for extensive vegetated roof covers is typically 85% to 97% non-organic (wet combustion or loss on ignition methods).</li> <li>▪ Vegetated roof covers intended to achieve water quality benefits should not be fertilized</li> <li>▪ Irrigation is not a desirable component of vegetated covers used as best management practices</li> <li>▪ Internal building drainage, including provisions to cover and protect deck drains or scuppers, must anticipate the need to manage large rainfall events without inundating the cover.</li> <li>▪ Assemblies planned for roofs with pitches steeper than 2:12 must incorporate supplemental measures to insure stability against sliding. Structural considerations are required.</li> </ul>	<p style="text-align: center;"><b><u>Potential Applications</u></b></p> <p>Residential: Yes                  Commercial: Yes                  Ultra Urban: Yes                  Industrial: Yes                  Retrofit: Yes                  Highway/Road: None</p>
	<p style="text-align: center;"><b><u>Stormwater Functions</u></b></p> <p>Volume Reduction: Med/High                  Recharge: None                  Peak Rate Control: Low                  Water Quality: Medium</p>
	<p style="text-align: center;"><b><u>Water Quality Functions</u></b></p> <p>TSS: 85%                  TP: 85%                  NO3: 30%</p>

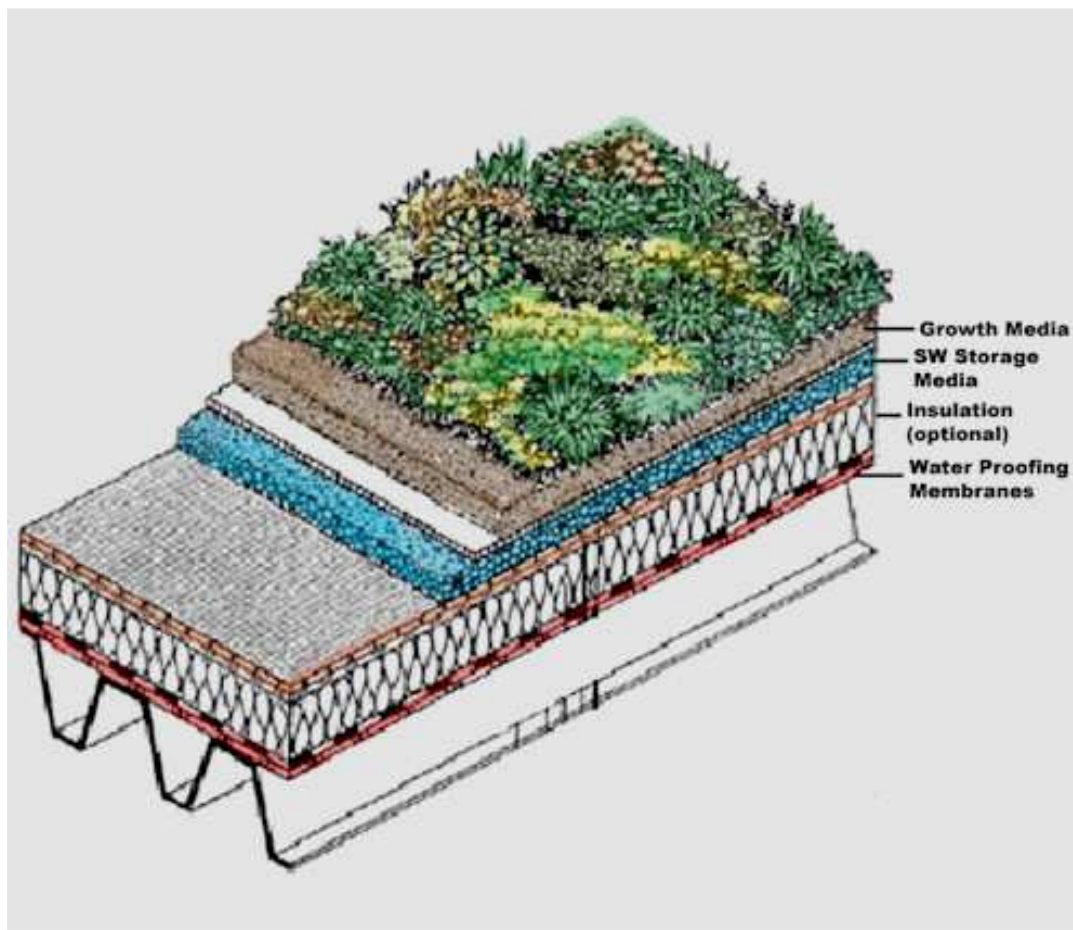
**Other Considerations**

- The roof structure must be evaluated for compatibility with the maximum predicted dead and live loads. Typical dead loads for wet extensive vegetated covers range from 8 to 36 pounds per square foot. Live load is a function of rainfall retention. For example, 2 inches of rain equals 10.4 lbs. per square foot of live load. It requires 20 inches of snow to have the same live load per square foot.
- The waterproofing must be resistant to biological and root attack. In many instances a supplemental root-fast layer is installed to protect the primary waterproofing membrane from plant roots.
- Standards and guidelines (in English) for the design of green roofs are available from FLL<sup>1</sup>, a European non-profit trade organization. In the United States, guidelines are in development by ASTM (American Standard Testing Methods).

## Description

Extensive vegetated roof covers are usually 6 inches or less in depth and are typically intended to achieve a specific environmental benefit, such as rainfall runoff mitigation. For this reason they are most commonly not irrigated. While some installations are open to public access, most extensive vegetated roof covers are for public viewing only. In order to make them practical for installation on conventional roof structures, lightweight materials are used in the preparation of most engineered media. Developments in the last 40 years that have made these systems viable include: 1) recognition of the value of vegetated covers in restoring near open-space hydrologic performance on impervious surfaces, 2) advances in waterproofing materials and methods, and 3) development of a reliable temperate climate plant list that can thrive under the extreme growing conditions on a roof.

Vegetated roof covers that are 10 inches, or deeper, are referred to as ‘intensive’ vegetated roof covers. These are more familiar in the United States and include many urban landscaped plazas. Intensive assemblies can also provide substantial environmental benefits, but are intended primarily to achieve aesthetic and architectural objectives. These types of systems are considered “roof gardens” and are not to be confused with the simple “extensive” design. Benefits beyond the stormwater considerations include temperature moderation and roof longevity.



## Variations

Most extensive vegetated roof covers fall into three categories

- Single media with synthetic under-drain layer
- Dual media
- Dual media with synthetic retention/detention layer

All vegetated roof covers will require a premium waterproofing system. Depending on the waterproofing materials selected, a supplemental root-fast layer may be required to protect the primary waterproofing membrane from plant roots.

Insulation, if included in the roof covering system, may be installed either above or below the primary waterproofing membrane. Most vegetated roof cover system can be adapted to either roofing configuration. In the descriptions that follow, the assemblies refer to the conventional configuration, in which the insulation layer is below the primary waterproofing.

All three extensive roof cover variations can be installed without irrigation. Non irrigated assemblies are strongly recommended. While this may place some limits on the type of plants that can be grown, the benefits are that the assembly will perform better as a stormwater BMP, and the maintenance requirements will be substantially reduced.

Some assemblies are installed in tray-like modules to facilitate installation, especially in confined locations.

### Single media assemblies

Single media assemblies are commonly used for pitched roof applications and for thin and lightweight installations. These systems typically incorporate very drought tolerant plants and utilize coarse engineered media with high permeability. A typical profile would include the following layers.

- Waterproofing membrane
- **Root-barrier** (optional, depending on the root-fastness of the waterproofing)
- Semi-rigid plastic **geocomposite drain** or **mat** (typical mats are made from non-biodegradable fabric or plastic foam)
- Separation geotextile
- Engineered **growth media**
- Foliage layer

Pitched roof applications may require the addition of slope bars, rigid slope stabilization panels, cribbing, reinforcing mesh, or similar method minimizing sliding instability.

Flat roof applications with mats as foundations typically require a network of perforated internal drainage conduit to enhance drainage of percolated rainfall to the deck drains or scuppers.

Assemblies with mats can be irrigated from beneath, while assemblies with drainage composites require direct drainage.

### Dual media assemblies

Dual media assemblies utilize two types of non-soil media. In this case a finer-grained media with some organic content is placed over a basal layer of coarse lightweight mineral aggregate. They do not include a geocomposite drain. The objective is to improve drought resistance by replicating a natural

growing environment in which sandy topsoil overlies gravelly subsoil. These assemblies are typically 4 to 6 inches thick and include the following layers:

- Waterproofing membrane
- Protection layer
- Coarse-grained **drainage media**
- Root-permeable nonwoven separation geotextile
- Fine-grained engineered growth media layer
- Foliage layer



These assemblies are suitable for roofs with pitches less than, or equal to, 1.5:12. Large vegetated covers will generally incorporate a network of perforated internal drainage conduit.

Dual media systems are ideal for use in combination with base irrigation methods.

**Dual media with synthetic retention/detention layer**

These assemblies introduce plastic panels with cup-like receptacles on their upper surface (i.e., a modified geocomposite drain sheet). The panels are in-filled with coarse lightweight mineral aggregate. The cups trap and retain water. They also introduce an air layer at the bottom of the assembly. A typical profile would include:

- Waterproofing membrane
- Felt fabric
- Retention/detention panel
- Coarse-grained drainage media
- Separation geotextile
- Fine grained 'growth' media layer
- Foliage layer

These assemblies are suitable on roof with pitches less than or equal to 1:12. Due to their complexity, these system are usually 5 inches or deeper.

If needed, irrigation can be provided via surface spray or mid-level drip.

- **Stormwater Volume and Rate Control**

Vegetated roof covers are an “at source” measure for reducing the rate and volume of runoff released during rainfall events. The water retention and detention properties of vegetated roof covers can be enhanced through proper selection of the engineered media and plants.

- **Runoff Water Quality Improvements**

Direct runoff from roofs is often a contributor to NPS pollutant discharges. Vegetated roof covers can significantly reduce this source of pollution. Assemblies intended to produce water quality benefits should employ engineered media with 100% mineral content. Following the plant establishment period (usually about 18 months), on-going fertilization of the cover should not be permitted. Experience indicates that it will take five or more years for a water quality vegetated cover to attain its maximum potential pollutant removal efficiency.

- **In Combination with Infiltration Measures**

Vegetated roof covers are frequently combined with ground infiltration measures. Vegetated roof covers improve the efficiency of infiltration devices by:

- Reducing the peak runoff rate
- Prolonging the runoff
- Filtering runoff to produce a clear effluent

Roofs that are designed to achieve water quality improvements will also reduce pollutant inputs to infiltration devices.

- **Habitat Restoration/Creation**

Vegetated roof covers have been used to create functional meadows and wetlands to mitigate the development of open space. This can be accomplished with assemblies as thin as 6 inches.

## Design Considerations

1. Live and **dead load** bearing capacity of the roof need to be established. Dead loads should be estimated using media weights determined using a standardized laboratory procedure.<sup>1</sup>
2. **Waterproofing** materials must be durable under the conditions associated with vegetated covers. A supplemental root-barrier layer should be installed in conjunction with materials that are not root-fast.
3. Roof flashings should extend 6 inches higher than the top of the growth media surface and be protected by counter-flashings.
4. The design should incorporate measures to protect the waterproofing membrane from physical damage during and after installation of the vegetated cover assembly.
5. Vegetated roof covers should incorporate internal drainage capacity sufficient to accommodate a two-year return frequency rainfall without generating surface runoff flow.
6. Deck drains, scuppers, or gravel stops serving as methods to discharge water from the roof area should be protected with **access chambers**. These enclosures should include removable lids in order to allow ready access for inspection.

7. The physical properties of the engineered media should be selected appropriately in order to achieve the desired hydrologic performance.
8. Engineered media should contain no clay size particles and should contain no more than 15% **organic matter** (wet combustion or loss on ignition methods)
9. Media used in constructing vegetated roof covers should have a maximum moisture capacity<sup>2</sup> of between 30% and 40%.
10. Plants should be selected which will create a vigorous, drought-tolerant ground cover. In Pennsylvania the most successful and commonly used ground covers for non irrigated projects are varieties of *Sedum* and *Delosperma*. In the Pennsylvania climate *Delosperma* is deciduous. Both deciduous and evergreen varieties of *Sedum* are available. Deeper assemblies (i.e., 4 to 6 inches) can also incorporate a wider range of plants including *Dianthus*, *Phlox*, *Antennaria*, and *Carex*.
11. Roofs with pitches exceeding 2:12 should be provided with supplemental measures to insure stability against sliding





## Detailed Stormwater Functions

The performance of vegetated roof covers as stormwater best management practices cannot be represented by a simple algebraic expression. Conventional methods are used to estimate surface runoff from various types of surfaces. In the analysis of vegetated roof covers, the water that is discharged from the roof is not surface runoff, but rather underflow, (i.e., percolated water). The rate and quantity of water released during a particular design storm can be predicted based on knowledge of key physical properties, including:

- Maximum media water retention
- Field capacity
- Plant cover type
- Saturated hydraulic conductivity
- Non-capillary porosity

The maximum media water retention is the maximum quantity of water that can be held against gravity under drained conditions. Standards that have been developed specifically for measuring this quantity in roof media are available from FLL and ASTM (draft).

## Peak Rate Mitigation

Vegetated roof covers can exert an influence on runoff peak rates derived from roofs. A general rule is to consider the first portion of the rainfall fills the volume reduction capacity (see below).

## Volume Reduction Calculations

All vegetated roof covers have both a retention and a detention volume component. Benchmarks for these volumes can be developed from the physical properties described above (*Detailed Stormwater Functions*).

The interaction of retention and detention produce both short-term effects (i.e., control of single storms) and long-term effects (i.e., reductions in total seasonal or annual roof runoff). Continuous simulation using a representative annual rainfall record from a local weather station is required in order to predict the long-term runoff versus rainfall benefit. The effectiveness of vegetated roof covers will vary according to the regional pattern of rainfall.

Using the German RWS program, the designer could generate a table of volume reductions for several regions in Pennsylvania. The table would relate the runoff ratio (runoff/rainfall) based on one or two types of cover assemblies and selected regions in PA for which good weather data is available. For the table to be used, a vegetated cover would have to comply with European guidelines.

## Water Quality Improvement

Once the plant cover is established, nutrient additions should be suspended. Experience indicates that the efficiency of vegetated covers in reducing pollutant and nutrient releases from roofs will increase with time. The vegetated cover should reach its optimum performance after about five years.

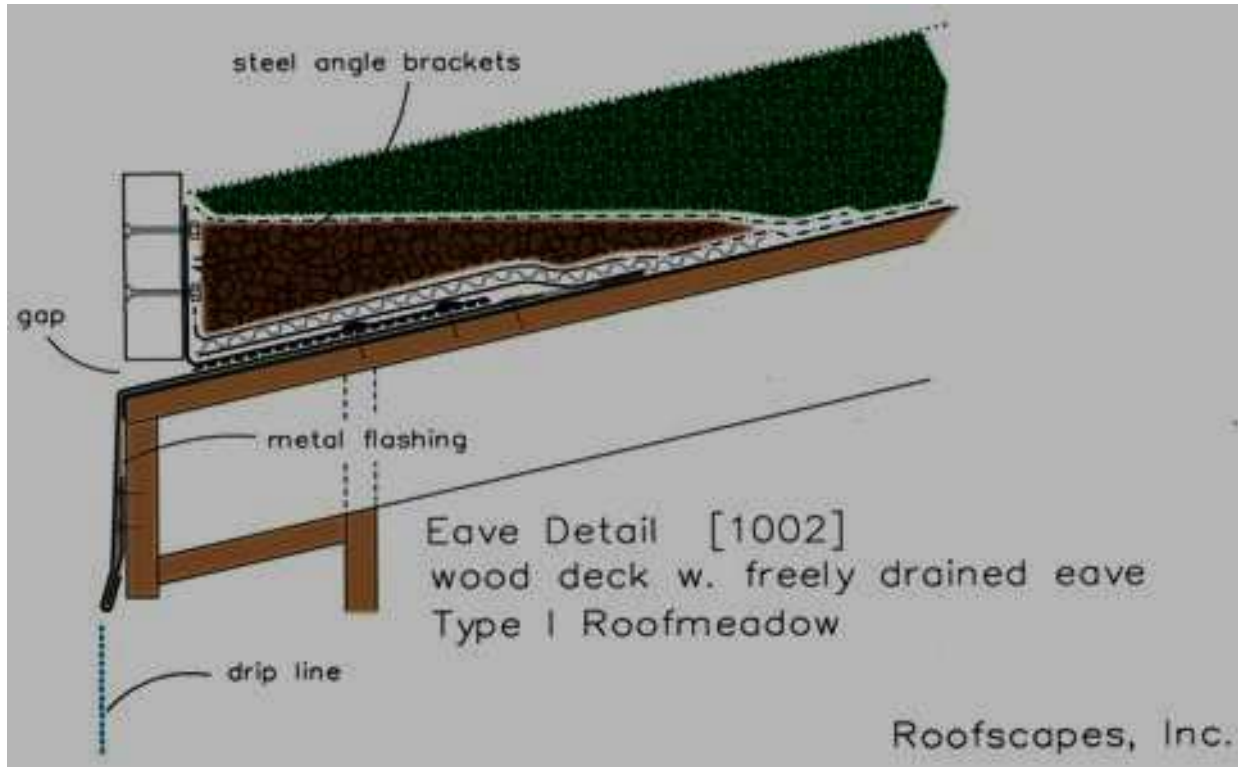
See Section 8 for Water Quality Improvement methodology that addresses pollutants removal effectiveness of this BMP.

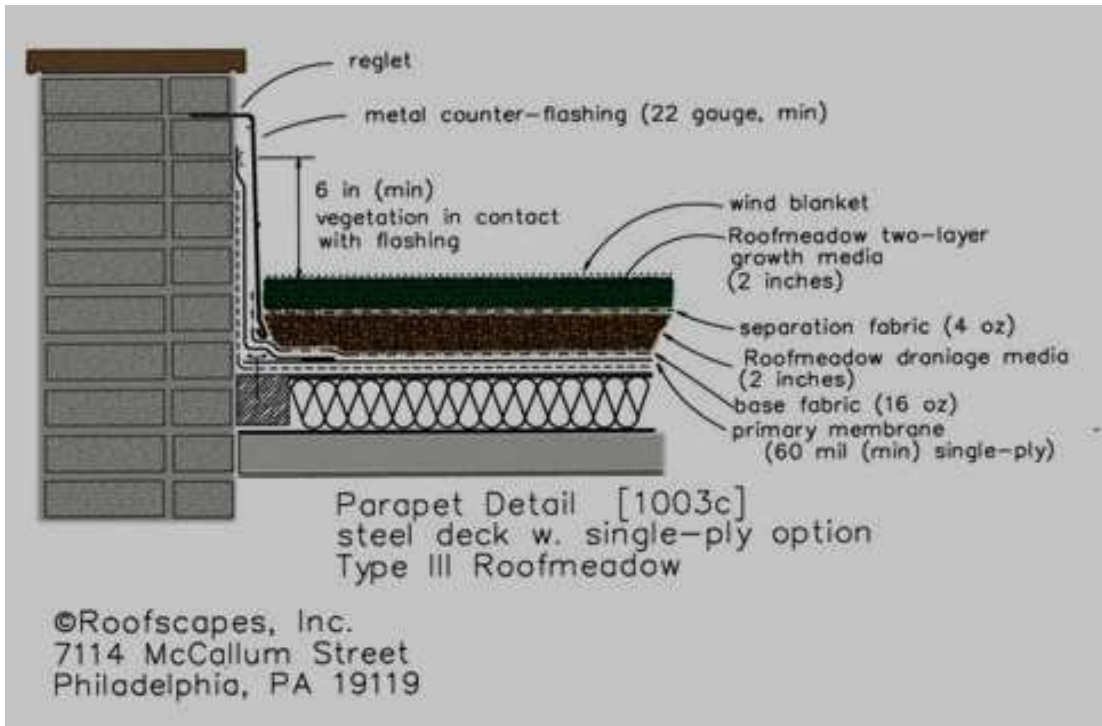


**Construction Sequence**

1. Visually inspect the completed waterproofing to identify any apparent flaws, irregularities, or conditions that will be interfere with the security or functionality of the vegetated covers system. The waterproofing should be tested for watertightness by the roofing applicator.
2. Institute a leak protection program
3. Introduce measures to protect the finished waterproofing from physical damage
4. Install slope stabilization measures (pitched roofs with pitches in excess of 2:12). In some installations slope stabilizing measures can be introduced as part of the roof structure and will be already be in-place at the start of the construction sequence.
5. If the waterproofing materials are not root fast, install a root-barrier layer
6. Layout key drainage and irrigation components, including drain access chambers, internal drainage conduit, confinement border units, and isolation frames (for roof-top utilities, hatches and penetrations)
7. Install walkways and paths (projects with public access)
8. Test irrigation systems (as relevant for roof gardens)
9. Install the drainage layer. Depending on the variation type, this could be a geocomposite drain, mat, or course of drainage media.
10. Cover the drainage layer with the separation fabric (in some assemblies, the separation fabric is pre-bonded to a synthetic drainage layer).

11. Install the upper growth media layer (dual media assemblies only)
12. Establish the foliage cover plantings from cuttings, seed, plugs or pre-grown mats
13. Provide protection from wind disruptions as warranted by the project conditions, and plant establishment method.





**Maintenance Issues**

- During the plant establishment period, periodic irrigation may be required
- During the plant establishment period, three to four visits to conduct basic weeding, fertilization, and in-fill planting is recommended. Thereafter, only two annual visits for inspection and light weeding should be needed (irrigated assemblies will require more intensive maintenance).

**Cost Issues**

The construction cost of vegetated roof covers can vary greatly, depending on factors such as:

- Height of the building
- Accessibility to the structure by large equipment such as cranes and trailers
- Depth and complexity of the assembly
- Remoteness of the project from sources of material supply
- Size of the project

However, under present market conditions (2004), extensive vegetated covers for roof will typically range between \$8 and \$15 per square foot, including design, installation, and warranty service. Basic maintenance for extensive vegetated covers typically requires about 3 man-hours per 1,000 square feet, annually.

## Specifications

The following specifications are provided for information purposes only. These specifications include information on acceptable materials for typical applications, but are by no means exclusive or limiting. The designer is responsible for developing detailed specifications for individual design projects in accordance with the project conditions.

Due to the very large variation in assembly types and methods, it is not possible to provide a comprehensive specification. Performance specifications, describing the assembly elements and their physical properties can be obtained from commercial providers of vegetated roof covers. The references provided also offer specific guidance for the selection of materials and methods.

Some key components and associated performance-related properties are as follows:

1. **Root-barriers** should be thermoplastic membranes with a thickness of at least 30 mils. Thermoplastic sheets can be bonded using hot-air fusion methods, rendering the seams safe from root penetration. Membranes that have been certified for use as root-barriers are recommended. At present only FLL offers a recognized test for root-barriers. Several FLL-certified materials are available in the United States. Interested American manufactures can submit products for testing to FLL-certified labs.

2. **Granular drainage media** should be a non-carbonate mineral aggregate conforming to the following specifications:

Saturated Hydraulic Conductivity <sup>2</sup>	25 in/min
Total Organic Matter, by Wet Combustion (MSA)	1%
Abrasion Resistance (ASTM-C131-96)	25% loss
Soundness (ASTM-C88 or T103 or T103-91)	5% loss
Porosity (ASTM-C29)	25%
Alkalinity, CaCO <sub>3</sub> equivalents (MSA)	1 %
Grain-Size Distribution (ASTM-C136)	
Pct. Passing US#18 sieve	1%
Pct. Passing ¼-inch sieve	30%
Pct. Passing 3/8-inch sieve	80%

3. **Growth media** should be a soil-like mixture containing not more than 15% organic content (wet combustion or loss on ignition methods). The appropriate grain-size distribution is essential for achieving the proper moisture content, permeability, nutrient management, and non-capillary porosity, and 'soil' structure. The grain-size guidelines vary for single and dual media vegetated cover assemblies.

Non-capillary Pore Space at Field Capacity, 0.333 bar (TMECC 03.01, A)	15% (vol)
Moisture Content at Field Capacity (TMECC 03.01, A)	12% (vol)
Maximum Media Water Retention (FLL)	30% (vol)
Alkalinity, Ca CO <sub>3</sub> equivalents (MSA)	2.5%

Total Organic Matter by Wet Combustion (MSA)	3-15% (dry wt.)
pH (RCSTP)	6.5-8.0
Soluble Salts (DTPA saturated media extraction)"(RCSTP)	6 mmhos/cm
Cation exchange capacity (MSA)	10 meq/100g
Saturated Hydraulic Conductivity for Single Media Assemblies (FLL) <sup>3</sup>	0.05 in/min
Saturated Hydraulic Conductivity for Dual Media Assemblies (FLL)	0.30 in/min
Grain-size Distribution of the Mineral Fraction (ASTM-D422)	
Single Media Assemblies	
Clay fraction (2 micron)	0
Pct. Passing US#200 sieve (i.e., silt fraction)	5%
Pct. Passing US#60 sieve	10%
Pct. Passing US#18 sieve	5 - 50%
Pct. Passing 1/8-inch sieve	20 - 70%
Pct. Passing 3/8-inch sieve	75 -100%
Dual Media Assemblies	
Clay fraction (2 micron)	0
Pct. Passing US#200 sieve (i.e., silt fraction)	5-15%
Pct. Passing US#60 sieve	10-25%
Pct. Passing US#18 sieve	20 - 50%
Pct. Passing 1/8-inch sieve	55 - 95%
Pct. Passing 3/8-inch sieve	90 -100%

Macro- and micro-nutrients shall be incorporated in the formulation in initial proportions suitable for support the specified planting.

**4. Separation fabric** should be readily penetrated by roots, but provide a durable separation between the drainage and growth media layers (Only lightweight nonwoven geotextiles are recommended for this function.

Unit Weight (ASTM-D3776)	4.25 oz/yd <sup>2</sup>
Grab tensile (ASTM-D4632)	90 lb
Mullen Burst Strength (ASTM-D4632)	135 lb/in
Permittivity (ASTM-D4491)	2 sec-1

## References

FLL: Guidelines for the Planning, Installation, and Maintenance in Roof Greening, 1995, English Version (*Richtlinien für die Planung, Ausführung und Pflege von Dachbegrünungen*), Forschungsgesellschaft Landschaftsentwicklung Landschaftsbau e.V.

ASTM: American Standard Testing Methods

Planting Green Roofs and Living Walls, 2004, Dunnett, N, and Kingsbury, N, Timber Press [ISBN 0-88192-640-X]

Penn State Center For Green Roof Research, <http://hortweb.cas.psu.edu/research/greenroofcenter/>

## FOOTNOTES

- <sup>1</sup> FLL or ASTM procedures for determining the maximum density and associated moisture content under compressed and hydrated conditions. See ASTM Draft: Standard Test Method for Maximum Media Density for Dead Load Analysis of Green Roof Systems , and ASTM Draft Standard Practice for Determination of Dead Loads and Live Loads for Green Roof Systems
- <sup>2</sup> ASTM Draft: Standard Test Method for Saturated Hydraulic Conductivity of Granular Drainage Media [Falling-Head Method] for Green Roof Systems





## BMP 6.5.2: Runoff Capture & Reuse



Capture and Reuse encompasses a wide variety of water storage techniques designed to “capture” precipitation, hold it for a period of time, and reuse the water. Heavy rainfall may require slow release over time. A water budget must be developed to ensure that the water will be used to allow for more runoff capture

<p style="text-align: center;"><b><u>Key Design Elements</u></b></p> <ul style="list-style-type: none"> <li>▪ Storage techniques may include cisterns, underground tanks, above-ground vertical storage tanks, rain barrels or other systems</li> <li>▪ Storage devices designed to capture a portion of the small, frequent storm events</li> <li>▪ Most effective when designed to meet a specific water need for reuse</li> <li>▪ Systems must for bypass or overflow of large storm events</li> <li>▪ Water budget analysis incorporating anticipated water inflow and usage is required</li> <li>▪ Collection and placement of storage elements up gradient of areas of reuse may reduce or eliminate pumping needs Maintenance - periodic tank and sump cleanout is required</li> </ul>	<p style="text-align: center;"><b><u>Potential Applications</u></b></p> <p style="text-align: center;">Residential: Yes Commercial: Yes Ultra Urban: Yes Industrial: Yes Retrofit: Yes Highway/Road: Limited</p> <hr/> <p style="text-align: center;"><b><u>Stormwater Functions</u></b></p> <p>Volume Reduction:      Med/High Recharge:                      Low      Low Peak Rate Control:      Medium Water Quality:</p> <hr/> <p style="text-align: center;"><b><u>Water Quality Functions</u></b></p> <p style="text-align: center;">TSS: 100% TP: 100% NO3: 100%</p>
---	--

## Description

Cisterns, Rain Barrels, Vertical Storage, and similar devices have been used for centuries to capture storm water from the roofs of buildings, and in many parts of the world these systems serve as a primary water supply source. The reuse of stormwater for potable needs is not advised without water treatment, although many homes in the U.S. were storing water in cisterns for reuse as little as a century ago. These systems can reduce potable water needs for uses such as irrigation and fire protection while also reducing stormwater discharges.

Storage/reuse techniques range from small, residential systems such as Rain Barrels that are maintained by the homeowner to supplement garden needs, to large, “vertical storage” units that can provide firefighting needs. Storage/reuse techniques are useful in urban areas where there is little physical space to manage storm water.

## Variations

**Cisterns** – large, underground or surface containers designed to hold large volumes of water (500 gallons or more). Cisterns may be comprised of fiberglass, concrete, plastic, brick or other materials.



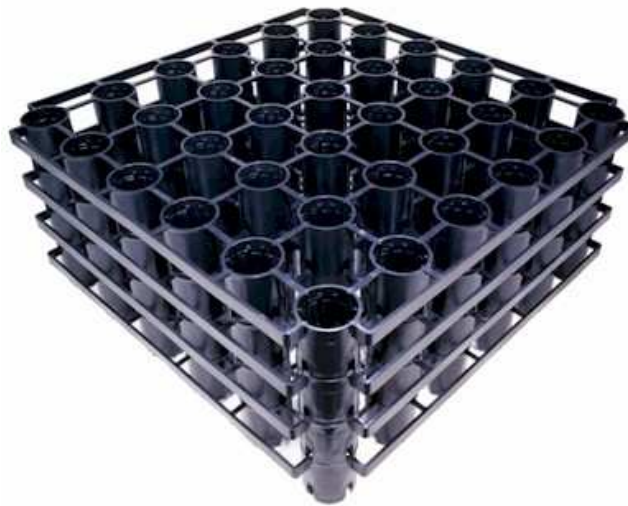
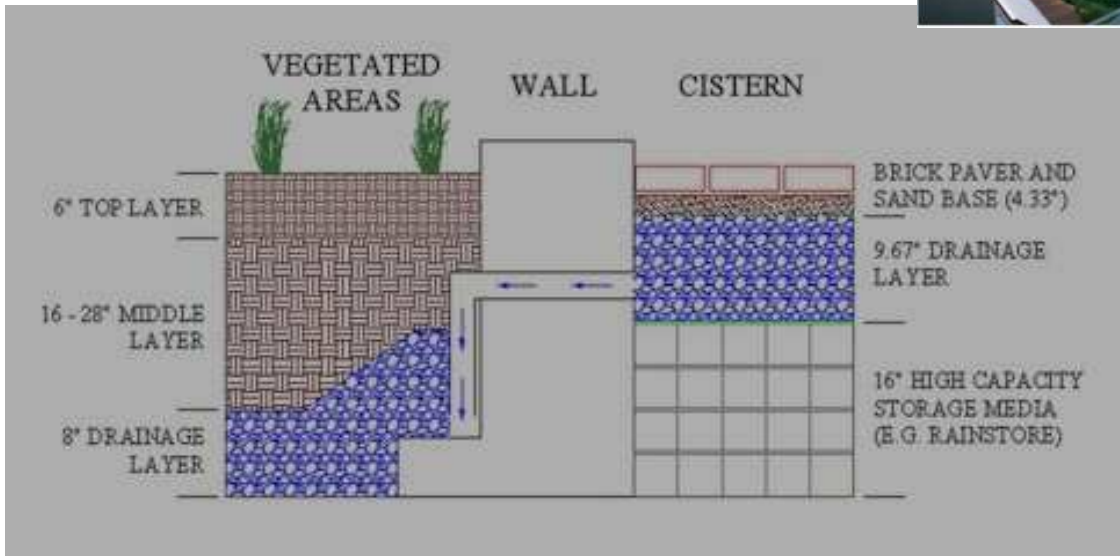
**Rain barrels** – barrel (or large container) that collect drainage from roof leaders and store water until needed for irrigation.



**Vertical Storage** – stand along “towers”, or “fat downspouts” that usually rest against a building performing the same capture, storage and release functions as cisterns and rain barrels.

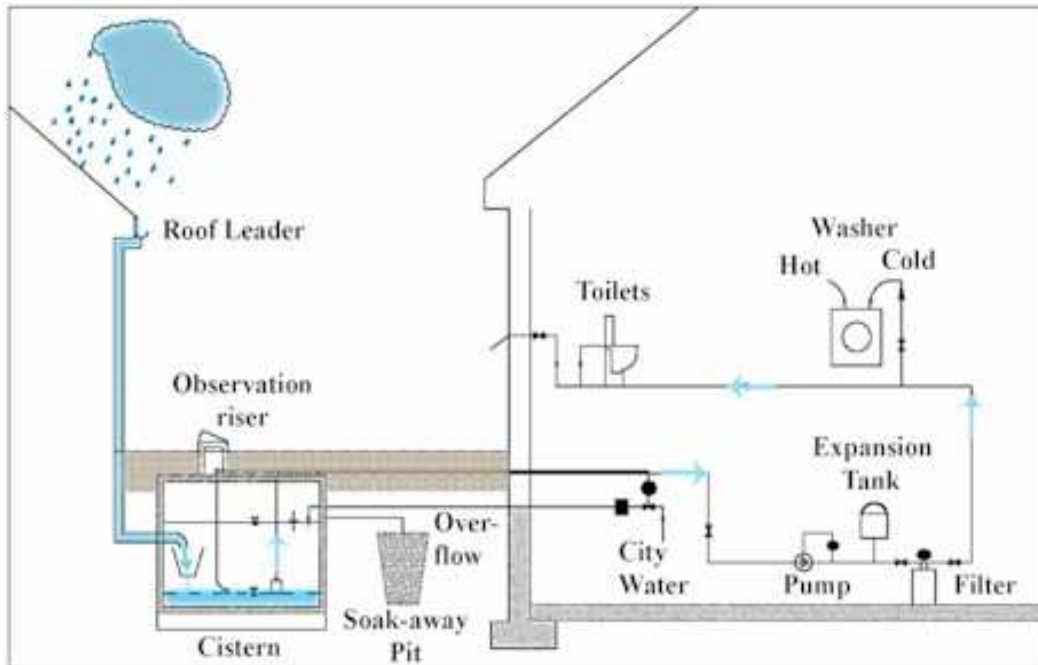


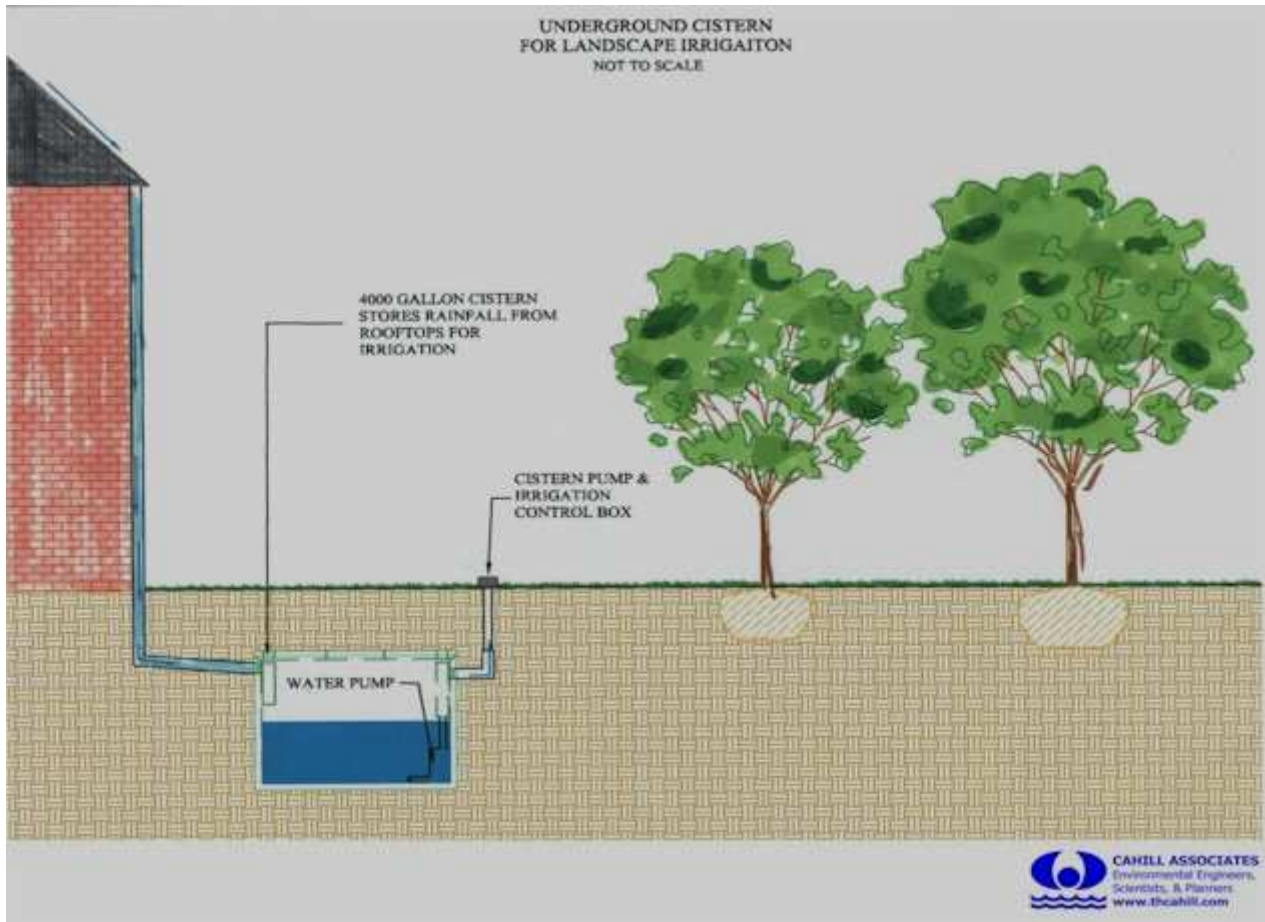
**Storage Beneath Structure** – Storage may be incorporated into elements such as paths and walkways to supplement irrigation with the use of structural plastic storage units



### Applications

- Landscaped areas and gardens to meet irrigation needs
- Storage for firefighting needs
- Urban areas and Combined Sewer areas to reduce peak surcharges.
- Reuse for greywater needs such as flushing toilets.
- Reuse for athletic field irrigation





### Design Considerations

1. The Designer should **calculate the water need** for the intended uses. For example, what will the collected water be used for and when will it be needed? If a 2,000 square foot area of lawn requires irrigation for 4 months in the summer at a rate of 1" per week, how much will be needed and how often will the storage unit be refilled? The usage requirements and the expected rainfall volume and frequency should be determined.
2. **Drawdown** – the Designer should provide for use or release of the stored water between storm events in order for the necessary stormwater storage volume to be available.
3. The **Catchment Area** on which the rain falls should be considered. The catchment area typically handles roof runoff.
4. The **Conveyance System** should keep reused stormwater or greywater from other potable water piping systems. Do not connect to domestic or commercial potable water system.
5. Pipes or storage units should be clearly marked "Caution: Reclaimed water, Do Not Drink".
6. Screens may be used to filter debris from storage units.

7. The **first flush** runoff may be diverted away from storage in order to minimize sediment and pollutant entry. However, rooftop runoff contains very low concentrations of pollutants.
8. Storage elements should be protected from direct sunlight by positioning and landscaping. (Limit light into devices to minimize algae growth.)
9. The proximity to building foundations should be considered for overflow conditions.
10. Climate is an important consideration, and capture/reuse systems should be designed to account for the potential of freezing.
11. Cisterns should be watertight (joints sealed with nontoxic waterproof material) with a smooth interior surface, and capable of receiving water from rainwater harvesting system.
12. Covers (lids) should have a tight fit to keep out surface water, animals, dust and light.
13. Positive outlet for overflow should be provided a few inches from the top of the cistern.
14. Observation risers should be at least 6" above grade for buried cisterns.
15. Reuse may require pressurization. Water stored has a pressure of 0.43 psi per foot of water elevation. A ten-foot tank would have a pressure of  $0.43 \times 10 = 4.3$  psi. at the bottom of the tank. Most irrigation systems require at least 15 psi. To add pressure, a pump, pressure tank and fine mesh filter can be used, which adds to the cost of the system, but creates a more usable system.

<b>Capacities of Various sized Cisterns (cf)</b>							
<b>Depth (ft)</b>	<b>Diameter of Round Types (ft)</b>						
	<b>6</b>	<b>8</b>	<b>10</b>	<b>12</b>	<b>14</b>	<b>16</b>	<b>18</b>
<b>6</b>	1266	2256	3522	5076	6906	9018	11412
<b>8</b>	1688	3008	4696	6768	9208	12024	15216
<b>10</b>	2110	3760	5870	8460	11510	15030	19020
<b>12</b>	2532	4512	7044	8532	13812	18036	22824
<b>14</b>	2954	5264	8218	11844	16114	21042	26628
* Harvested Rainwater Guidelines, GreenBuilder.com							

Annual Rainfall Yield in Gallons for Various Impervious Surface Sizes and Rainfall Amounts									
Impervious Surface Area sf	Rainfall (inches)								
	20	24	28	32	36	40	44	48	52
1000	11844	14213	16582	18951	21319	23688	26057	28426	30795
1100	13029	15634	18240	20846	23451	26057	28663	31268	33874
1200	14213	17056	19898	22741	25583	28426	31268	34111	36954
1300	15397	18477	21556	24636	27715	30795	33874	36954	40033
1400	16582	19898	23214	26531	29847	33164	36480	39796	43113
1500	17766	21319	24873	28426	31979	35532	39086	42639	46192
1600	18951	22741	26531	30321	34111	37901	41691	45481	49272
1700	20135	24162	28189	32216	36243	40270	44297	48324	52351
1800	21319	25583	29847	34111	38375	42639	46903	51167	55431
1900	22504	27005	31505	36006	40507	45008	49508	54009	58510
2000	23688	28426	33164	37901	42639	47377	52114	56852	61589
2100	24873	29847	34822	39796	44771	49745	54720	59694	64669
2200	26057	31268	36480	41691	46903	52114	57326	62537	67748
2300	27241	32690	38138	43586	49035	54483	59931	65380	70828
2400	28426	34111	39796	45481	51167	56852	62537	68222	73907
2500	29610	35532	41454	47377	53299	59221	65143	71065	76987
2600	30795	36954	43113	49272	55431	61589	67748	73907	80066
2700	31979	38375	44771	51167	57562	63958	70354	76750	83146
2800	33164	39796	46429	53062	59694	66327	72960	79593	86225

\* Values represent 95% of actual precipitation to account for any storage and/or losses.

## Detailed Stormwater Functions

### Volume Reduction Calculations

Volume reduction is the actual volume of the storage container, taking into consideration how many times it is emptied.

### Peak Rate Mitigation Calculations:

Capture and reuse takes a volume of water out of site runoff. This reduction in volume will translate to a lower overall peak rate for the site.

### Water Quality Improvement

Pollutant removal takes place through filtration of recycled primary storage, and/or natural filtration through soil and vegetation for overflow discharge. Quantifying pollutant removal will depend on design. Sediment removal will depend on area below outlet that is designed for sediment accumulation, time in storage, and maintenance frequency. Filtration through soil will depend on flow rate, the type of soil (infiltration capacity), and design specifics (stone bed, etc.).

### Construction Sequence

Install per manufacturer’s instructions.

### Maintenance Issues

Flush cisterns to remove sediment. Brush the inside surfaces and thoroughly disinfect.

Winter concern: Do not allow water to freeze in devices. (Empty out before water freezes.)

## Cost Issues

Rain Barrel: ranges from \$80 to \$200, average for residential use is \$150 (2005)

Cistern: varies, depending on material used (reinforced concrete, steel, plastic are common), size, and pump characteristics

Vertical Storage: ranges from \$88 for 64-gallon capacity to \$10,516 for 12,000-gallon capacity (for a plastic, manufactured product). Storage costs \$1.25/gallon (2005).

General: the reuse of water for irrigation or other uses saves money on water costs over time.

## Specifications:

The following specifications are provided for informational purposes only. These specifications include information on acceptable materials for typical applications, but are by no means exclusive or limiting. The designer is responsible for developing detailed specifications for individual design projects in accordance with the project conditions.

1. **Vertical Storage** All storage containers should meet FDA specifications for stored drinking water if potable water is the intended use. Follow Manufacturer's specifications for vertical storage containers.



## References

City of Tucson, Water Harvesting Guidance Manual, March 2003 (edited by Ann Audrey Phillips, prepared for the City of Tucson, Department of Transportation, Stormwater Section)

“What are Rainwater Harvesting and Stormwater Recycling?” Heather Kinkade-Levario, ASLA and Hari Krishna Ph.D., P.E., Ann Phillips, Tim Pope

Sustainable Building Sourcebook, “Harvested Rainwater Guidelines”, sections 1.0, 2.0, 3.0  
[www.greenbuilder.com](http://www.greenbuilder.com)

“Rainwater Harvesting” [www.ci.austin.tx.us/greenbuilder/fs\\_rainharvest.htm](http://www.ci.austin.tx.us/greenbuilder/fs_rainharvest.htm) City of Austin, TX

Portland, OR’s Code Guide Office of Planning & Development Review “Rainwater Harvesting – ICC – RES/34/#1 & UPC/6/#2, March 2001

U.S. EPA National Pollutant Discharge Elimination System, “Post-Construction Storm Water Management in New Development & Redevelopment, On-Lot Treatment”

City of Vancouver, Engineering Services, Water and Sewers “Rain Barrel Program”

“Cisterns/Rainwater Harvesting Systems, [www.advancedbuildings.org](http://www.advancedbuildings.org) Technologies and Practices, Plumbing & Water Heating

CSIRO, Land and Water, “Urban Water Reuse – Frequently Asked Questions” (south Australia)

“Rain Barrels – Truth or Consequences” Karen Sands, AICP and Thomas Chapman, P.E., Milwaukee Metropolitan Sewerage District, Milwaukee, Wisconsin

“Hydrologic Processes at the Residential Scale” Qingfu Xiao, E. Gregory McPherson, James R. Simpson, Hydrologic Sciences Program, UC Davis, Center for Urban Forest Research, USDA Forest Service

“Black Vertical Storage Tanks by Norwesco” [www.precisionpump.net/storagetanksystems.htm](http://www.precisionpump.net/storagetanksystems.htm)



## **6.6 Runoff Quality/Peak Rate BMPs**



## BMP 6.6.1: Constructed Wetland



Constructed Wetlands are shallow marsh systems planted with emergent vegetation that are designed to treat stormwater runoff.

<p style="text-align: center;"><b><u>Key Design Elements</u></b></p> <ul style="list-style-type: none"> <li>▪ Adequate drainage area (usually 5 to 10 acres minimum) or proof of sustained base flow                      May require investigation of water supply to ensure a sustained baseflow to maintain the wetland</li> <li>▪ Maintenance of permanent water surface</li> <li>▪ Multiple vegetative growth zones through varying depths</li> <li>▪ Robust and diverse vegetation</li> <li>▪ Relatively impermeable soils or engineered liner</li> <li>▪ Sediment collection and removal</li> <li>▪ Adjustable permanent pool and dewatering mechanism                      Maintenance - periodic sediment removal from the forebay and vegetation maintenance</li> </ul>	<p style="text-align: center;"><b><u>Potential Applications</u></b></p> <p>Residential: Yes                      Commercial: Yes                      Ultra Urban: Limited                      Industrial: Yes                      Retrofit: Yes                      Highway/Road: Yes</p>
	<p style="text-align: center;"><b><u>Stormwater Functions</u></b></p> <p>Volume Reduction: Low                      Recharge: Low                      Peak Rate Control: High                      Water Quality: High</p>
	<p style="text-align: center;"><b><u>Water Quality Functions</u></b></p> <p>TSS: 85%                      TP: 85%                      NO3: 30%</p>

## Description

Constructed Wetlands are shallow marsh systems planted with emergent vegetation that are designed to treat stormwater runoff. While they are one of the best BMPs for pollutant removal, Constructed Wetlands (CWs) can also mitigate peak rates and even reduce runoff volume to a certain degree. They also can provide considerable aesthetic and wildlife benefits. CWs use a relatively large amount of space and require an adequate source of inflow to maintain the permanent water surface.

## Variations

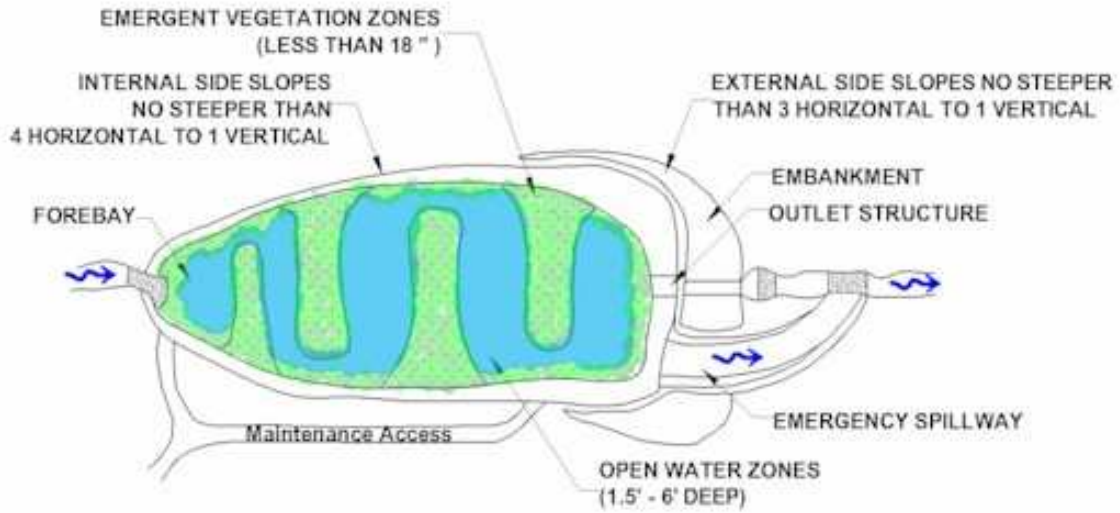
Constructed Wetlands can be designed as either an online or offline facilities. They can also be used effectively in series with other flow/sediment reducing BMPs that reduce the sediment load and equalize incoming flows to the CWs. Constructed Wetlands are a good option for retrofitting existing detention basins. CWs are often organized into four groups:

- Shallow Wetlands are large surface area CWs that primarily accomplish water quality improvement through displacement of the permanent pool.
- Extended Detention Shallow Wetlands are similar to Shallow Wetlands but use extended detention as another mechanism for water quality and peak rate control.
- Pocket Wetlands are smaller CWs that serve drainage areas between approximately 5 and 10 acres and are constructed near the water table.
- Pond/Wetland systems are a combination of a wet pond and a constructed wetland.

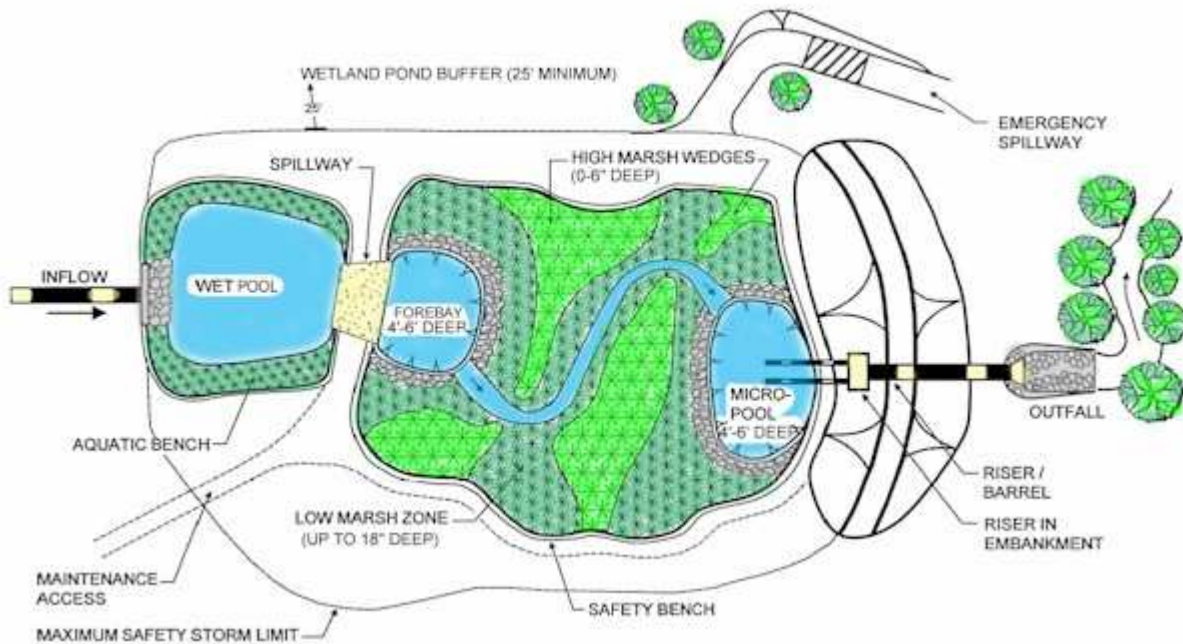
Although this BMP focuses on surface flow Constructed Wetlands as described above, subsurface flow CWs can also be used to treat stormwater runoff. While typically used for wastewater treatment, subsurface flow CWs for stormwater may offer some advantages over surface flow wetlands, such as improved reduction of total suspended solids and oxygen demand. They also can reduce the risk of vectors (especially mosquitoes) and safety risks associated with open water. However, nitrogen removal may be deficient (Campbell and Ogden, 1999). Perhaps the biggest disadvantage is the relatively low treatment capacities of subsurface flow CWs – they are generally only able to treat small flows. For more information, please consult the “References and Additional Resources” list.

**Applications**

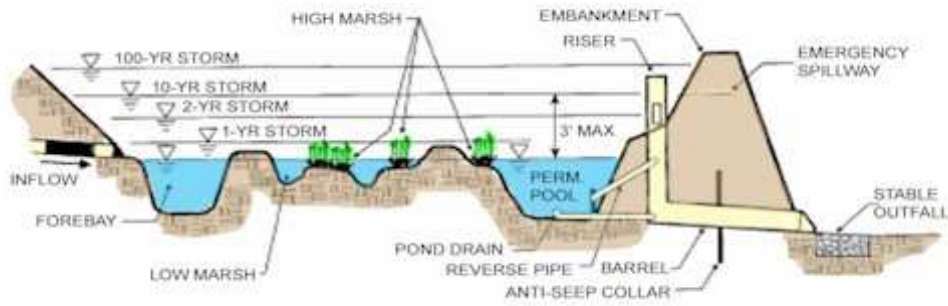
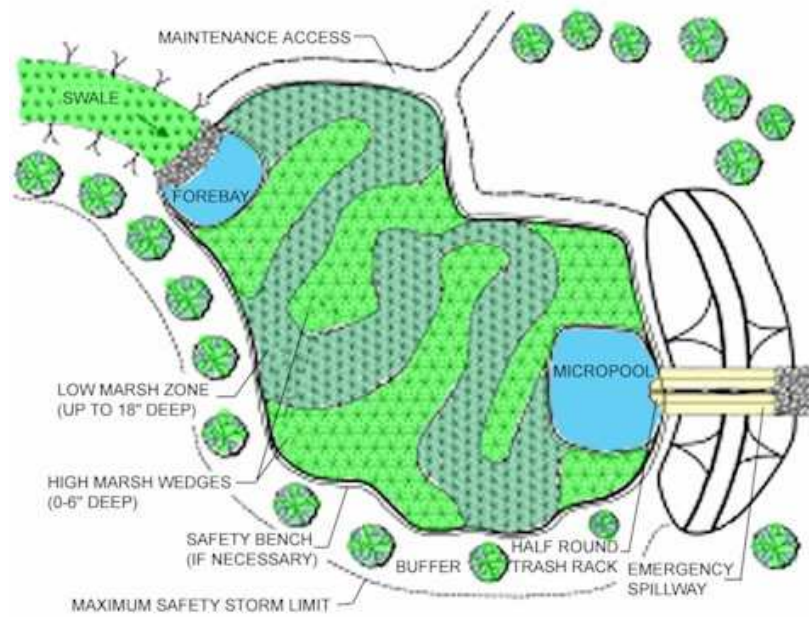
- **Alternating bands of deeper water and shallow marsh.**



- **Wet Pond/Wetland System**



- Pocket Wetland**



- Offline Constructed Wetland**
- Retrofit of existing detention basins**





### Design Considerations

1. **HYDROLOGY.** Constructed Wetlands must be able to receive and retain enough flow from rain, runoff, and groundwater to ensure long-term viability. Hydrologic calculations (or a water balance) should be performed to verify this. Shallow marsh areas can become dry at the surface but not for greater than one month, even in the most severe drought. A permanent water surface in the deeper areas of the CWs should be maintained during all but the driest periods. A relatively stable normal water surface elevation will reduce the stress on wetland vegetation. A CWs must have a drainage area of at least 10 acres (5 acres for “pocket” wetlands) or some means of sustaining constant inflow. Even with a large drainage area, a constant source of inflow can improve the biological health and effectiveness of a Constructed Wetland. Pennsylvania’s precipitation is generally well distributed throughout the year and is therefore suited for CWs.
2. **UNDERLYING SOILS.** Underlying soils must be identified and tested. Generally hydrologic soil groups “C” and “D” are suitable without modification, “A” and “B” soils may require a clay or synthetic liner. Soil permeability must be tested in the proposed Constructed Wetland location to ensure that excessive infiltration will not cause the CWs to dry out. If necessary, CWs should have a highly- compacted subsoil or an impermeable liner to minimize infiltration.
3. **PLANTING SOIL.** Organic soils should be used for Constructed Wetlands. Organic soils can serve as a sink for pollutants and generally have high water holding capacities. They will also facilitate plant growth and propagation and may hinder invasion of undesirable species.
4. **SIZE AND VOLUME.** The area required for a CWs is generally 3 to 5 percent of its drainage area. CWs should be sized to treat the water quality volume and, if necessary, to mitigate the peak rates for larger events.
5. **VEGETATION.** Vegetation is an integral part of a Wetland system. Vegetation may help to reduce flow velocities, promote settling, provide growth surfaces for beneficial microbes, uptake pollutants, prevent resuspension, provide filtering, limit erosion, prevent short-circuiting, and maintain healthy bottom sediments (Braskerud, 2001). Constructed Wetlands should have several different zones of vegetation as described in Table 6.6.1-1. The emergent vegetation zone (areas not more than 18” deep) should comprise about 60 to 65 percent of the normal water surface area, although recommendations in recent literature range from less than 50 to over 80 percent. Robust, non-invasive, perennial plants that establish quickly are ideal for CWs. The designer should select species that are tolerant of a range of depths, inundation periods, etc. Monoculture planting must be avoided due to the risk from pests and disease. Use local recommended plant lists.

Table 6.6.1-1

Vegetation Zone	Description
Open Water	Areas between 18 inches and 6 feet deep
Emergent	Areas up to 18 inches deep
Low Marsh	Portion of Emergent Zone between 6 and 18 inches deep
High Marsh	Portion of Emergent Zone up to 6 inches deep
Ephemeral Storage	Area periodically inundated during runoff events
Buffer	Area outside of maximum water surface elevation



6. CONFIGURATION.

- a. General. Constructed Wetlands should be designed with a length to width ratio of at least 2:1 wherever possible. If the length to width ratio is lower, the flow pathway through the CWs should be maximized. CWs should not be constructed within 10 feet of the property line or within 50 feet of a private well or septic system. CWs should be designed so that the 10-year water surface elevation does not exceed the normal water surface elevation by more than 3 feet. Slopes in and around Constructed Wetlands should be 4:1 to 5:1 (H:V) wherever possible. Constructed wetlands should be located outside of any natural watercourse.
- b. Forebay/Inflows. Constructed Wetlands should have a forebay at all major inflow points to capture coarse sediment, prevent excessive sediment accumulation in the remainder of the CWs, and minimize erosion by inflow. The forebays should contain 10 to 15 percent of the total permanent pool volume and should be 4 to 6 feet deep (at least as deep as other open water areas). They should be physically separated from the rest of the wetland by a berm, gabion wall, etc. Flows exiting the forebay should be non-erosive to the newly constructed CWs. Vegetation within forebays can increase sedimentation and reduce resuspension/erosion. The forebay bottom can be hardened to facilitate sediment removal. Forebays should be installed with permanent vertical markers that indicate sediment depth. Inflow channels should be fully stabilized. Inflow pipes can discharge to the surface or be partially submerged. CWs should be protected from the erosive force of the inflow to prevent the resuspension of previously collected sediment during large flows.



- c. Vegetation and Open Water Zones. About half of the emergent vegetation zone should be high marsh (up to 6" deep) and half should be low marsh (6" to 18" deep). Varying depths throughout the CWs can improve plant diversity and health. The open water zone (approx. 35 to 40% of the total surface area) should be between 18 inches and 6 feet deep. Allowing a limited 5-foot deep area can prevent short-circuiting by encouraging mixing, enhance aeration of water, prevent resuspension, minimize thermal

- impacts, and limit mosquito growth. Alternating areas of emergent vegetation zone (up to 18 inches deep) and open water zone – as shown in Figures 6.13-2 and 6.13-4 – can also minimize short-circuiting and hinder mosquito propagation.
- d. **Outlet.** Outlet control devices should be in open water areas 4 to 6 feet deep comprising about 5 percent of the total surface area to prevent clogging and allow the CWs to be drained for maintenance. Outlet devices are generally multistage structures with pipes, orifices, or weirs for flow control. Orifices should be at least 2.5 inches in diameter and should be protected from clogging. Outlet devices should be installed in the embankment for accessibility. It is recommended that outlet devices enable the normal water surface to be varied. This allows the water level to be adjusted (if necessary) seasonally, as the CWs accumulates sediment over time, if desired grades are not achieved, or for mosquito control. The outlet pipe should generally be fitted with an anti-seep collar. Online facilities should have an emergency spillway that can safely pass the 100-year storm with 1 foot of freeboard. All outflows should be conveyed downstream in a safe and stable manner.
  - e. **Safety Benches.** All areas that are deeper than 4 feet should have two safety benches, each 4 to 6 feet wide. One should be situated about 1 to 1.5 feet above the normal water elevation and the other 2 to 2.5 feet below the water surface.
7. **CONSTRUCTED WETLAND BUFFER.** To enhance habitat value, visual aesthetics, and wetland health, a 25-foot buffer should be added from the maximum water surface elevation. The buffer should be planted with trees, shrubs, and native ground covers. Existing trees within the buffer should be preserved. If soils in the buffer will become compacted during construction, soil restoration should take place to aid buffer vegetation.
  8. **MAINTENANCE ACCESS.** Permanent access must be provided to the forebay, outlet, and embankment areas. It should be at least 9 feet wide, have a maximum slope of 15%, and be stabilized for vehicles.
  9. **PLAN ELEMENTS.** The plans detailing the Constructed Wetlands should clearly show the CWs configuration, elevations and grades, depth/vegetation zones, and the location, quantity, and propagation methods of wetland/buffer vegetation. Plans should also include site preparation techniques, construction sequence, as well as maintenance schedules and requirements.
  10. **REGULATION.** Constructed Wetlands that have drainage areas over 100 acres, embankments greater than 15 feet high, or a capacity greater than 50 acre-feet may be regulated as a dam by PADEP (see Title 25, Chapter 105 of the Pennsylvania Code).

## Detailed Stormwater Functions

### Volume Reduction Calculations

Although not typically considered a volume-reducing BMP, Constructed Wetlands can achieve some volume reduction through evapotranspiration, especially during small storms. An evapotranspiration study could be done to account for potential volume reduction credit. Hydrologic calculations that should be performed to verify that the CWs will have a viable amount of inflow can also predict the water surface elevation under varying conditions. The volume stored between the predicted water level and the lowest outlet elevation will be removed from the storm that occurs under those conditions.

### Peak Rate Mitigation Calculations

Peak rate is primarily controlled in Constructed Wetlands through the transient storage above the normal water surface. See in Section 8 for Peak Rate Mitigation methodology.

### Water Quality Improvement

Constructed Wetlands improve runoff quality through settling, filtration, uptake, chemical and biological decomposition, volatilization, and adsorption. Constructed Wetlands are effective at removing many common stormwater pollutants including suspended solids, heavy metals, total phosphorus, total nitrogen, toxic organics, and petroleum products. The pollutant removal effectiveness varies by season and may be affected by the age of the wetland. It has been suggested that Constructed wetlands do not remove nutrients in the long term unless vegetation is harvested because captured nutrients are released back into the water by decaying plant material. Even if this is true, nutrients are generally released gradually and during the non-growing season when downstream susceptibility is generally low (Hammer, 1990). See in Section 8 for Water Quality Improvement methodology which addresses pollutant removal effectiveness of this BMP.

### Construction Sequence

1. Separate wetland area from contributing drainage area:
  - a. All channels/pipes conveying flows to the Constructed Wetland must be routed away from the wetland area until it is completed and stabilized.
  - b. The area immediately adjacent to the Constructed Wetland must be stabilized in accordance with the PADEP's Erosion and Sediment Pollution Control Program Manual (2000 or latest edition) prior to construction of the wetland.
2. Clearing and Grubbing:
  - a. Clear the area to be excavated of all vegetation.
  - b. Remove all tree roots, rocks, and boulders.
  - c. Fill all stump holes, crevices and similar areas with impermeable materials.
3. Excavate bottom of Constructed Wetland to desired elevation (Rough Grading).
4. Install surrounding embankments and inlet and outlet control structures.
5. Grade and compact subsoil.
6. Apply and grade planting soil.
  - a. Matching design grades is crucial because aquatic plants can be very sensitive to depth.
7. Apply geo-textiles and other erosion-control measures.
8. Seed, plant and mulch according to Planting Plan
9. Install any anti-grazing measures, if necessary.
10. Follow required maintenance and monitoring guidelines.



**Maintenance Issues**

Constructed Wetlands must have a maintenance plan and privately owned facilities should have an easement, deed restriction, or other legal measure to prevent neglect or removal. During the first growing season, vegetation should be inspected every 2 to 3 weeks. During the first 2 years, CWs should be inspected at least 4 times per year and after major storms (greater than 2 inches in 24 hours). Inspections should access the vegetation, erosion, flow channelization, bank stability, inlet/outlet conditions, and sediment/debris accumulation. Problems should be corrected as soon as possible. Wetland and buffer vegetation may require support – watering, weeding, mulching, replanting, etc. – during the first 3 years. Undesirable species should be removed and desirable replacements planted if necessary.

Once established, properly designed and installed Constructed Wetlands should require little maintenance. They should be inspected at least semiannually and after major storms as well as rapid ice breakup. Vegetation should maintain at least an 85 percent cover of the emergent vegetation zone. Annual harvesting of vegetation may increase the nutrient removal of CWs; it should generally be done in the summer so that there is adequate regrowth before winter. Care should be taken to minimize disturbance, especially of bottom sediments, during harvesting. The potential disturbance from harvesting may outweigh its benefits unless the CWs receives a particularly high nutrient load or discharges to a nutrient sensitive waterbody. Sediment should be removed from the forebay before it occupies 50 percent of the forebay, typically every 3 to 7 years.

**Cost Issues**

The construction cost of Constructed Wetlands can vary greatly depending on the configuration, location, site-specific conditions, etc. Typical construction costs in 2004 dollars range from approximately \$30,000 to \$65,000 per acre (USEPA Wetlands Fact Sheet, 1999). Costs are generally most dependent on the amount of earthwork and the planting. Annual maintenance costs have been reported to be approximately 2 to 5 percent of the capital costs although there is very little data available to support this.

**Specifications:**

The following specifications are provided for information purposes only. These specifications include information on acceptable materials for typical applications, but are by no means exclusive or limiting.

The designer is responsible for developing detailed specifications for individual design projects in accordance with the project conditions.

1. **Excavation**

- a. The area to be used for the CWs should be excavated to the required depth below the desired bottom elevation to accommodate any required impermeable liner, organic matter, and/or planting soil.
- b. The compaction of the subgrade and/or the installation of any impermeable liners will follow immediately.

2. **Subsoil Preparation**

- a. Subsoil shall be free from hard clods, stiff clay, hardpan, ashes, slag, construction debris, petroleum hydrocarbons, or other undesirable material. Subsoil must not be delivered in a frozen or muddy state.
- b. Scarify the subsoil to a depth of 8 to 10 inches with a disk, rototiller, or similar equipment.
- c. Roll the subsoil under optimum moisture conditions to a dense seal layer with four to six passes of a sheepfoot roller or equivalent. The compacted seal layer shall be at least 8 inches thick.

3. **Impermeable Liner**

- a. If necessary, install impermeable liner in accordance with manufacturer's guidelines.
- b. Place a minimum 12 inches of subsoil on top of impermeable liner in addition to planting soil.

4. **Planting Soil (Topsoil)**

- a. See Local Specifications for general Planting Soil requirements.
- b. Use a minimum of 12 inches of topsoil in marsh areas of the Wetland. If natural topsoil from the site is to be used it must have at least 8 percent organic carbon content (by weight) in the A-horizon for sandy soils and 12% for other soil types.
- c. If planting soil is being imported it should be made up of equivalent proportions of organic and mineral materials.
- d. Lime should not be added to planting soil unless absolutely necessary as it may encourage the propagation of invasive species.
- e. The final elevations and hydrology of the wetland zones should be evaluated prior to planting to determine if grading or planting changes are required.

5. **Vegetation**

- a. Plant Lists for Constructed Wetlands can be found in Appendix B. No substitutions of specified plants will be accepted without prior approval of the designer. Planting locations shall be based on the Planting Plan and directed in the field by a qualified wetland ecologist.
- b. All wetland plant stock shall exhibit live buds or shoots. All plant stock shall be turgid, firm, and resilient. Internodes of rhizomes may be flexible and not necessarily rigid. Soft or mushy stock shall be rejected. The stock shall be free of deleterious insect infestation, disease and defects such as knots, sun-scald, injuries, abrasions, or disfigurement that could adversely affect the survival or performance of the plants.
- c. All stock shall be free from invasive or nuisance plants or seeds such as those listed in Appendix B.
- d. During all phases of the work, including transport and onsite handling, the plant materials shall be carefully handled and packed to prevent injuries and desiccation. During transit and onsite handling, the plant material shall be kept from freezing and shall be kept covered, moist, cool, out of the weather, and out of the wind and sun. Plants shall be watered to maintain moist soil and/or plant conditions until accepted.
- e. Plants not meeting these specifications or damaged during handling, loading, and unloading will be rejected.

f. Detailed planting specifications can be found in Appendix B.

6. **Outlet Control Structure**

- a. Outlet control structures shall be constructed of non-corrodible material.
- b. Outlets shall be resistant to clogging by debris, sediment, floatables, plant material, or ice.
- c. Materials shall comply with applicable specifications (PennDOT or AASHTO, latest edition)

## References

Auckland Regional Council, 2003. *Stormwater Management Devices: Design Guidelines Manual*, Auckland, New Zealand

Braskerud, B.C. "Influence of Vegetation on Sedimentation and Resuspension of Soil Particles in Small Constructed Wetlands," *Journal of Environmental Quality*, Vol. 30: pp. 1447-1457, 2001.

California Stormwater Quality Association, 2003. *California Stormwater Best Management Practices Handbook: New Development and Redevelopment*.

Campbell, C. and Ogden, M. *Constructed Wetlands in the Sustainable Landscape*. John Wiley & Sons Inc., 1999.

Caraco, D. and Claytor, R. *Stormwater BMP Design Supplement for Cold Climates*. 1997. USEPA BMP Fact Sheet

Atlanta Regional Commission. *Georgia Stormwater Management Manual*. 2004.

Hammer, D. (Editor). *Constructed Wetlands for Wastewater Treatment*. Lewis Publishers, 1990.

Center for Watershed Protection and Maryland Department of the Environment, 2000. *2000 Maryland Stormwater Design Manual*, Baltimore, MD

University of California: Division of Agriculture and Natural Resources. *Managing Mosquitos in Surface Flow Constructed Treatment Wetlands*. 1998.

New Jersey Department of Environmental Protection, 2004. *New Jersey Stormwater Best Management Practices Manual*.

Pennsylvania Department of Environmental Protection, 2000. *Erosion and Sediment Pollution Control Program Manual*.

City of Portland Environmental Services, 2002. *City of Portland Stormwater Management Manual: Revision #2*.

Wetlands: Characteristics and Boundaries. Committee on Characterization of Wetlands, National Research Council (1995)





## BMP 6.6.2: Wet Pond/Retention Basin

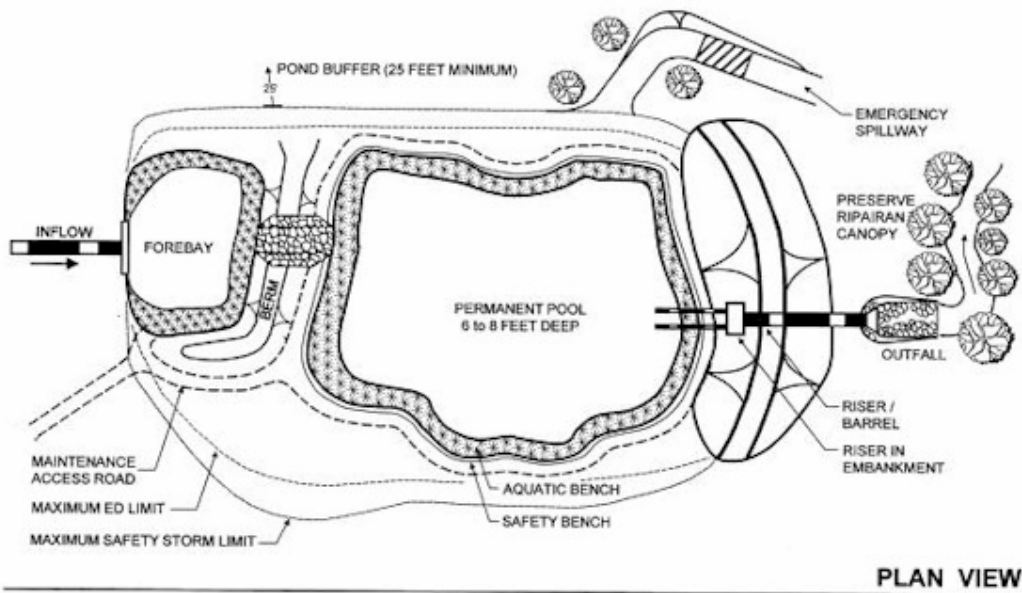


Wet Ponds/Retention Basins are stormwater basins that include a substantial permanent pool for water quality treatment and additional capacity above the permanent pool for temporary runoff storage.

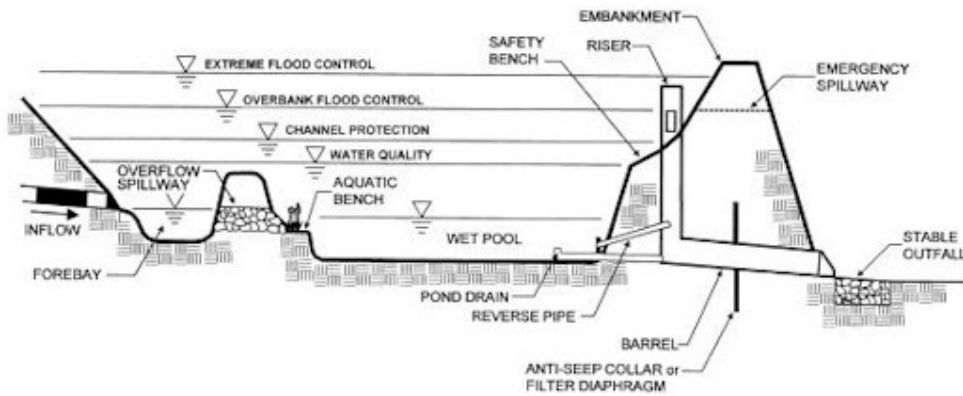
<p style="text-align: center;"><b><u>Key Design Elements</u></b></p> <ul style="list-style-type: none"> <li>▪ Adequate drainage area (usually 5 to 10 acres minimum) or proof of sustained baseflow</li> <li>▪ Natural high groundwater table</li> <li>▪ Maintenance of permanent water surface</li> <li>▪ Should have at least 2 to 1 length to width ratio</li> <li>▪ Robust and diverse vegetation surrounding wet pond</li> <li>▪ Relatively impermeable soils</li> <li>▪ Forebay for sediment collection and removal</li> <li>▪ Dewatering mechanism</li> </ul>	<p style="text-align: center;"><b><u>Potential Applications</u></b></p> <p style="text-align: center;">Residential: Yes                  Commercial: Yes                  Ultra Urban: Yes                  Industrial: Yes                  Retrofit: Yes                  Highway/Road: Yes</p> <hr/> <p style="text-align: center;"><b><u>Stormwater Functions</u></b></p> <p style="text-align: center;">Volume Reduction: Low                  Recharge: Low                  Peak Rate Control: High                  Water Quality: Medium</p> <hr/> <p style="text-align: center;"><b><u>Water Quality Functions</u></b></p> <p style="text-align: center;">TSS: 70%                  TP: 60%                  NO3: 30%</p>
--	---

### Description

Wet Detention Ponds are stormwater basins that include a permanent pool for water quality treatment and additional capacity above the permanent pool for temporary storage. Wet Ponds should include one or more forebays that trap coarse sediment, prevent short-circuiting, and facilitate maintenance. The pond perimeter should generally be covered by a dense stand of emergent wetland vegetation. While they do not achieve significant groundwater recharge or volume reduction, they can be effective for pollutant removal and peak rate mitigation. Wet Ponds (WPs) can also provide aesthetic and wildlife benefits. WPs require an adequate source of inflow to maintain the permanent water surface. Due to the potential to discharge warm water, wet ponds should be used with caution near temperature sensitive waterbodies. Properly designed and maintained WPs generally do not support significant mosquito populations (O'Meara).



PLAN VIEW



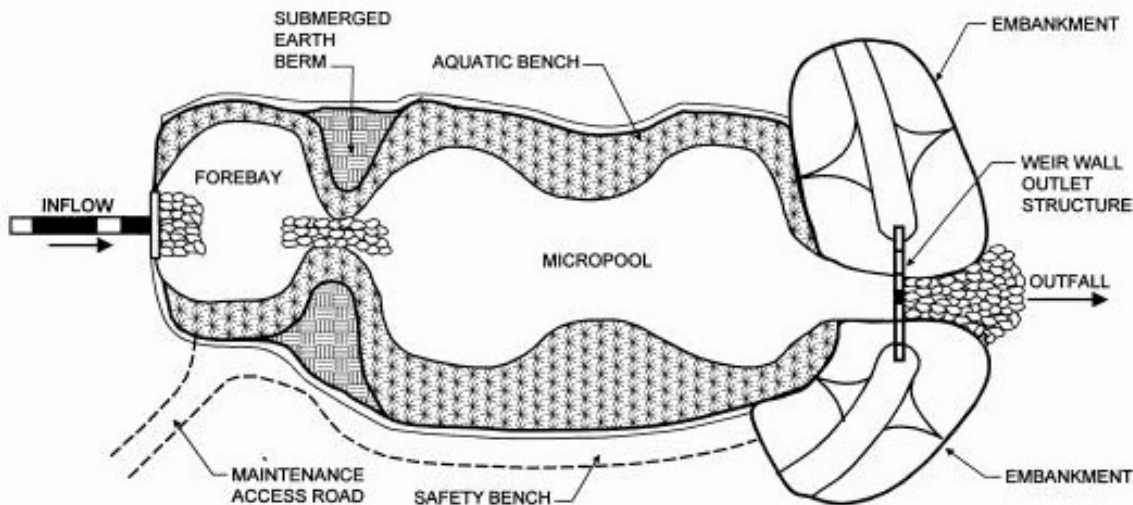
PROFILE

## Variations

Wet Ponds can be designed as either an online or offline facilities. They can also be used effectively in series with other sediment reducing BMPs that reduce the sediment load such as vegetated filter strips, swales, and filters. Wet Ponds may be a good option for retrofitting existing dry detention basins. WPs are often organized into three groups:

- Wet Ponds primarily accomplish water quality improvement through displacement of the permanent pool and are generally only effective for small inflow volumes (often they are placed offline to regulate inflow).
- Wet Detention Ponds are similar to Wet Ponds but use extended detention as another mechanism for water quality and peak rate control.
- Pocket Wet Ponds are smaller WPs that serve drainage areas between approximately 5 and 10 acres and are constructed near the water table to help maintain the permanent pool. They often include extended detention as well.

This BMP focuses on Wet Detention Ponds as described above because this tends to be the most common and effective type of Wet Pond. For more information on other types of wet ponds, please consult the “References and Additional Resources” list.



## Applications

- **Wet Ponds**
- **Wet Detention Ponds**
- **Pocket Wet Pond**
- **Offline Wet Pond**
- **Retrofit for existing detention basins**



### Design Considerations

1. HYDROLOGY. Wet Ponds should be able to receive and retain enough flow from rain, runoff, and groundwater to ensure long-term viability. A permanent water surface in the deeper areas of the WP should be maintained during all but the driest periods. A relatively stable permanent water surface elevation will reduce the stress on vegetation in and adjacent to the pond. A WP should have a drainage area of at least 10 acres (5 acres for Pocket Wet Ponds) or some means of sustaining constant inflow. Even with a large drainage area, a constant source of inflow can improve the biological health and effectiveness of a Wet Pond while discouraging mosquito growth. Pennsylvania’s precipitation is generally well distributed throughout the year and is therefore suited for WPs.
2. UNDERLYING SOILS. Underlying soils must be identified and tested. Generally hydrologic soil groups “C” and “D” are suitable without modification, “A” and “B” soils may require modification to reduce permeability. Soil permeability must be tested in the proposed Wet Pond location to ensure that excessive infiltration will not cause the WP to dry out.
3. PLANTING SOIL. Organic soils should be used for shallow areas within Wet Ponds. Organic soils can serve as a sink for pollutants and generally have high water holding capacities. They will also facilitate plant growth and propagation and may hinder invasion of undesirable species.
4. SIZE AND VOLUME. The area required for a WP is generally 1 to 3 percent of its drainage area. WPs should be sized to treat the water quality volume and, if necessary, to mitigate the peak rates for larger events.
5. VEGETATION. Vegetation is an integral part of a Wet Pond system. Vegetation in and adjacent to a pond may enhance pollutant removal, reduce algal growth, limit erosion, improve aesthetics, create habitat, and reduce water warming (Mallin et al., 2002; NJ DEP, 2004; University of Wisconsin, 2000). Wet Ponds should have varying depths to encourage vegetation in shallow areas. The emergent vegetation zone (areas not more than 18" deep) generally supports the majority of aquatic vegetation and should include the pond perimeter. Robust, non-invasive, perennial plants that establish quickly are ideal for WPs. The designer should select species that are tolerant of a range of depths, inundation periods, etc. Monoculture planting should be avoided due to the risk from pests and disease. See local sources for recommended plant lists or Appendix B.

## 6. CONFIGURATION.

- a. General. Wet Ponds should be designed with a length to width ratio of at least 2:1 wherever possible. If the length to width ratio is lower, the flow pathway through the WP should be maximized. A wedge-shaped pond with the major inflows on the narrow end can prevent short-circuiting and stagnation. WPs should not be constructed within 10 feet of the property line or within 50 feet of a private well or septic system. Slopes in and around Wet Ponds should be 4:1 to 5:1 (horizontal:vertical) or flatter wherever possible (10:1 max. for safety/aquatic benches, see 6.d. below). Wet Ponds should have an average depth of 3 to 6 feet and a maximum depth of 8 feet. This should be shallow enough to minimize thermal stratification and short-circuiting and deep enough to prevent sediment resuspension, reduce algal blooms, and maintain aerobic conditions. Wet ponds should not be constructed within a natural watercourse.
  - b. Forebay/Inflows. Wet Ponds should have a forebay at all major inflow points to capture coarse sediment, prevent excessive sediment accumulation in the remainder of the WP, and minimize erosion by inflow. The forebays should contain 10 to 15 percent of the total permanent pool volume and should be 4 to 6 feet deep. They should be physically separated from the rest of the pond by a berm, gabion wall, etc. Flows exiting the forebay should be non-erosive to the newly constructed WP. Vegetation within forebays can increase sedimentation and reduce resuspension/erosion. The forebay bottom can be constructed of hardened materials to facilitate sediment removal. Forebays should be installed with permanent vertical markers that indicate sediment depth. Inflow channels should be fully stabilized. Inflow pipes can discharge to the surface or be partially submerged. Forebays should be offline (out of the path of higher flows) to prevent resuspension of previously collected sediment during large storms.
  - c. Outlet. Outlet control devices should draw from open water areas 5 to 7 feet deep to prevent clogging and allow the WP to be drained for maintenance and to provide for additional temperature benefits. Outlet devices are generally multistage structures with pipes, orifices, or weirs for flow control. A reverse slope pipe terminating 2 to 3 feet below the normal water surface, minimizes the discharge of warm surface water and is less susceptible to clogging by floating debris. Orifices, if used, should be at least 2.5 inches in diameter and should be protected from clogging. Outlet devices should be installed in the embankment for accessibility. If possible, outlet devices should enable the normal water surface to be varied. This allows the water level to be adjusted (if necessary) seasonally, as the WP accumulates sediment over time, if desired grades are not achieved, or for mosquito control. A pond drain should also be included which allows the permanent pool to be completely drained for maintenance within 24 hours. The outlet pipe should generally be fitted with an anti-seep collar through the embankment. Online facilities should have an emergency spillway that can safely pass the 100-year storm with 1 foot of freeboard. All outflows should be conveyed downstream in a safe and stable manner.
  - d. Safety/Aquatic Benches. All areas that are deeper than 4 feet should have two safety benches, totaling 15 feet in width. One should start at the normal water surface and extend up to the pond side slopes at a maximum slope of 10 percent. The other should extend from the water surface into the pond to a maximum depth of 18 inches, also at slopes no greater than 10 percent.
7. WET POND BUFFER. To enhance habitat value, visual aesthetics, water temperature, and pond health, a 25-foot buffer should be added from the maximum water surface elevation. The buffer should be planted with trees, shrubs, and native ground covers. Except in maintenance access areas, turf grass should not be used. Existing trees within the buffer should be preserved. If soils in the buffer will become compacted during construction, soil restoration should take place to aid buffer vegetation.

8. **MAINTENANCE ACCESS.** Permanent access must be provided to the forebay, outlet, and embankment areas. It should be at least 9 feet wide, have a maximum slope of 15%, and be stabilized for vehicles.
9. **PLAN ELEMENTS.** The plans detailing the Wet Ponds should clearly show the WP configuration, inlets and outlets, elevations and grades, safety/aquatic benches, and the location, quantity, and propagation methods of pond/buffer vegetation. Plans should also include site preparation techniques, construction sequence, as well as maintenance schedules and requirements.
10. **REGULATION.** Wet Ponds that have drainage areas over 100 acres, embankments greater than 15 feet high, or a capacity greater than 50 acre-feet may be regulated as a dam by PADEP (see Title 25, Chapter 105 of the Pennsylvania Code).



## Detailed Stormwater Functions

### Volume Reduction Calculations

Although not typically considered a volume-reducing BMP, Wet Ponds can achieve some volume reduction through infiltration and evapotranspiration, especially during small storms. According to the International Stormwater BMP Database, wet ponds have an average annual volume reduction of 7 percent (Strecker et al., 2004). Hydrologic calculations that should be performed to verify that the WP will have a viable amount of inflow can also predict the water surface elevation under varying conditions. The volume stored between the predicted water level and the lowest outlet elevation will be removed from the that design storm.

### Peak Rate Mitigation Calculations

Peak rate is primarily controlled in Wet Ponds through the transient storage above the normal water surface. See Section 8 for Peak Rate Mitigation methodology.

### Water Quality Improvement

Wet Ponds improve runoff quality through settling, filtration, uptake, chemical and biological decomposition, volatilization, and adsorption. WPs are relatively effective at removing many common stormwater pollutants including suspended solids, heavy metals, total phosphorus, total nitrogen, and pathogens. The pollutant removal effectiveness varies by season and may be affected by the age of the WP. It has been suggested that this type of BMP does not provide significant nutrient removal in the long term unless vegetation is harvested because captured nutrients are released back into the water by decaying plant material. Even if this is true, nutrients are usually released gradually and during the non-growing season when downstream susceptibility is generally low (Hammer, 1990). See Section 8 for Water Quality Improvement methodology, which addresses pollutant removal effectiveness of this BMP.

## Construction Sequence

1. Separate wet pond area from contributing drainage area:
  - a. All channels/pipes conveying flows to the WP should be routed away from the WP area until it is completed and stabilized.
  - b. The area immediately adjacent to the WP should be stabilized in accordance with the PADEP's *Erosion and Sediment Pollution Control Program Manual* (2000 or latest edition) prior to construction of the WP.
2. Clearing and Grubbing:
  - a. Clear the area to be excavated of all vegetation.
  - b. Remove all tree roots, rocks, and boulders.
  - c. Fill all stump holes, crevices and similar areas with impermeable materials.
3. Excavate bottom of WP to desired elevation (Rough Grading).
4. Install surrounding embankments and inlet and outlet control structures.
5. Grade and prepare subsoil.

6. Apply and grade planting soil.
  - a. Matching design grades is crucial because aquatic plants can be very sensitive to depth.
7. Apply erosion-control measures.
8. Seed, plant and mulch according to Planting Plan
9. Install any anti-grazing measures, if necessary.
10. Follow required maintenance and monitoring guidelines.

### **Maintenance Issues**

Wet Ponds should have a maintenance plan and privately owned facilities should have an easement, deed restriction, or other legal measure to prevent neglect or removal. During the first growing season or until established, vegetation should be inspected every 2 to 3 weeks. WPs should be inspected at least 4 times per year and after major storms (greater than 2 inches in 24 hours) or rapid ice breakup. Inspections should assess the vegetation, erosion, flow channelization, bank stability, inlet/outlet conditions, embankment, and sediment/debris accumulation. The pond drain should also be inspected and tested 4 times per year. Problems should be corrected as soon as possible. Wet Pond and buffer vegetation may need support (watering, weeding, mulching, replanting, etc.) during the first 3 years. Undesirable species should be carefully removed and desirable replacements planted if necessary.

Once established, properly designed and installed Wet Ponds should require little maintenance. Vegetation should maintain at least an 85 percent cover of the emergent vegetation zone and buffer area. Annual harvesting of vegetation may increase the nutrient removal of WPs; if performed it should generally be done in the summer so that there is adequate regrowth before winter. Care should be taken to minimize disturbance, especially of bottom sediments, during harvesting. The potential disturbance from harvesting may outweigh its benefits unless the WP receives a particularly high nutrient load or discharges to a nutrient sensitive waterbody. Sediment should be removed from the forebay before it occupies 50 percent of the forebay, typically every 5 to 10 years.

### **Cost Issues**

The construction cost of Wet Ponds can vary greatly depending on the configuration, location, site-specific conditions, etc. Typical construction costs in 2004 dollars range from approximately \$25,000 to \$50,000 per acre-foot of storage (based on USEPA, 1999). Costs are generally most dependent on the amount of earthwork and the planting. Annual maintenance costs have been reported to be approximately 3 to 5 percent of the capital costs although there is little data available to support this. In addition to the construction and maintenance costs, there is the cost or loss of value for the property involved.

### **Specifications:**

The following specifications are provided for information purposes only. These specifications include information on acceptable materials for typical applications, but are by no means exclusive or limiting. The designer is responsible for developing detailed specifications for individual design projects in accordance with the project conditions.



**1. Excavation**

- a. The area to be used for the WP should be excavated to the required depth below the desired bottom elevation to accommodate any required impermeable liner, organic matter, and/or planting soil.
- b. The compaction of the subgrade and/or the installation of any impermeable liners will follow immediately.

**2. Subsoil Preparation**

- a. Subsoil shall be free from hard clods, stiff clay, hardpan, ashes, slag, construction debris, petroleum hydrocarbons, or other undesirable material. Subsoil must not be delivered in a frozen or muddy state.
- b. Scarify the subsoil to a depth of 8 to 10 inches with a disk, rototiller, or similar equipment.
- c. Roll the subsoil under optimum moisture conditions to a dense layer with four to six passes of a sheepfoot roller or equivalent. The compacted layer shall be at least 8 inches thick.

**3. Planting Soil (Topsoil)**

- a. Use a minimum of 12 inches of topsoil in the emergent vegetation zone (less than 18" deep) of the pond. If natural topsoil from the site is to be used it must have at least 8 percent organic carbon content (by weight) in the A-horizon for sandy soils and 12% for other soil types.
- b. If planting soil is being imported it should be made up of equivalent proportions of organic and mineral materials.
- c. Lime should not be added to planting soil unless absolutely necessary as it may encourage the propagation of invasive species.
- d. The final elevations and hydrology of the vegetative zones should be evaluated prior to planting to determine if grading or planting changes are required.

**4. Vegetation**

- a. Plant Lists for WPs can be found locally. No substitutions of specified plants will be accepted without prior approval of the designer. Planting locations shall be based on the Planting Plan and directed in the field by a qualified wetland ecologist.
- b. All Wet Pond plant stock shall exhibit live buds or shoots. All plant stock shall be turgid, firm, and resilient. Internodes of rhizomes may be flexible and not necessarily rigid. Soft or mushy stock shall be rejected. The stock shall be free of deleterious insect infestation, disease and defects such as knots, sun-scald, injuries, abrasions, or disfigurement that could adversely affect the survival or performance of the plants.
- c. All stock shall be free from invasive or nuisance plants or seeds.
- d. During all phases of the work, including transport and onsite handling, the plant materials shall be carefully handled and packed to prevent injuries and desiccation. During transit and onsite handling, the plant material shall be kept from freezing and shall be kept covered, moist, cool, out of the weather, and out of the wind and sun. Plants shall be watered to maintain moist soil and/or plant conditions until accepted.
- e. Plants not meeting these specifications or damaged during handling, loading, and unloading will be rejected.
- f. Detailed planting specifications can be found locally, and in Appendix B.

**5. Outlet Control Structure**

- a. Outlet control structures shall be constructed of non-corrodible material.
- b. Outlets shall be resistant to clogging by debris, sediment, floatables, plant material, or ice.
- c. Materials shall comply with applicable specifications (PennDOT or AASHTO, latest edition)

## References

- Auckland Regional Council. *Stormwater Management Devices: Design Guidelines Manual*. Auckland, New Zealand: 2003.
- Caraco, D. and Claytor, R. *Stormwater BMP Design Supplement for Cold Climates*. 1997.
- Center for Watershed Protection and Maryland Department of the Environment. *2000 Maryland Stormwater Design Manual*. Baltimore, MD: 2000.
- Center for Watershed Protection for NYS Department of Environmental Conservation. *New York State Stormwater Management Design Manual*. October 2001.
- CH2MHILL. *Pennsylvania Handbook of Best Management Practices for Developing Areas*. 1998.
- Cummings and Booth, circa 2003. "Stormwater Pollutant Removal by Two Wet Ponds in Bellevue, Washington." Department of Civil and Environmental Engineering, University of Washington, Seattle, WA, 23 pp.
- "Effectiveness of Best Management Practices (BMPs) for Stormwater Treatment." City of Greensboro (NC), Water Resources Department, circa 2000. Available as of October 2004 at <http://www.greensboro-nc.gov/stormwater/Quality/bmpeffectiveness.htm>.
- Federal Highway Administration, *Stormwater Best Management Practices in an Ultra-Urban Setting: Selection and Monitoring*. "Fact Sheet – Detention Basins."
- Hammer, D.A. (editor). *Constructed Wetlands for Wastewater Treatment, Municipal, Industrial and Agricultural*. Ann Arbor, MI: Lewis Publishers, 1990.
- Mallin, M.; Ensign, S.; Wheeler, T.; and Mayes; D. "Pollutant Removal Efficacy of Three Wet Detention Ponds." *Journal of Environmental Quality* 31: 654-660 (2002).
- New Jersey Department of Environmental Protection. *New Jersey Stormwater Best Management Practices Manual*. 2004.
- O'Meara, G.F. "Mosquito Associated with Stormwater Detention/Retention Areas." University of Florida, Institute of Food and Agricultural Sciences.
- Strecker, E.W.; Quigley, M.M.; Urbonas, B.; and Jones, J. "Analyses of the Expanded EPA/ASCE International BMP Database and Potential Implications for BMP Design." Proceedings of the World Water and Environmental Resources Congress 2004, Salt Lake City, Utah.
- United States Environmental Protection Agency (USEPA). *Storm Water Technology Fact Sheet: Wet Detention Ponds* (EPA 832-F-99-048) 1999.

## BMP 6.6.3: Dry Extended Detention Basin



A dry extended detention basin is an earthen structure constructed either by impoundment of a natural depression or excavation of existing soil, that provides temporary storage of runoff and functions hydraulically to attenuate stormwater runoff peaks. The dry detention basin, as constructed in countless locations since the mid-1970's and representing the primary BMP measure until now, has served to control the peak rate of runoff, although some water quality benefit accrued by settlement of the larger particulate fraction of suspended solids. This extended version is intended to enhance this mechanism in order to maximize water quality benefits.

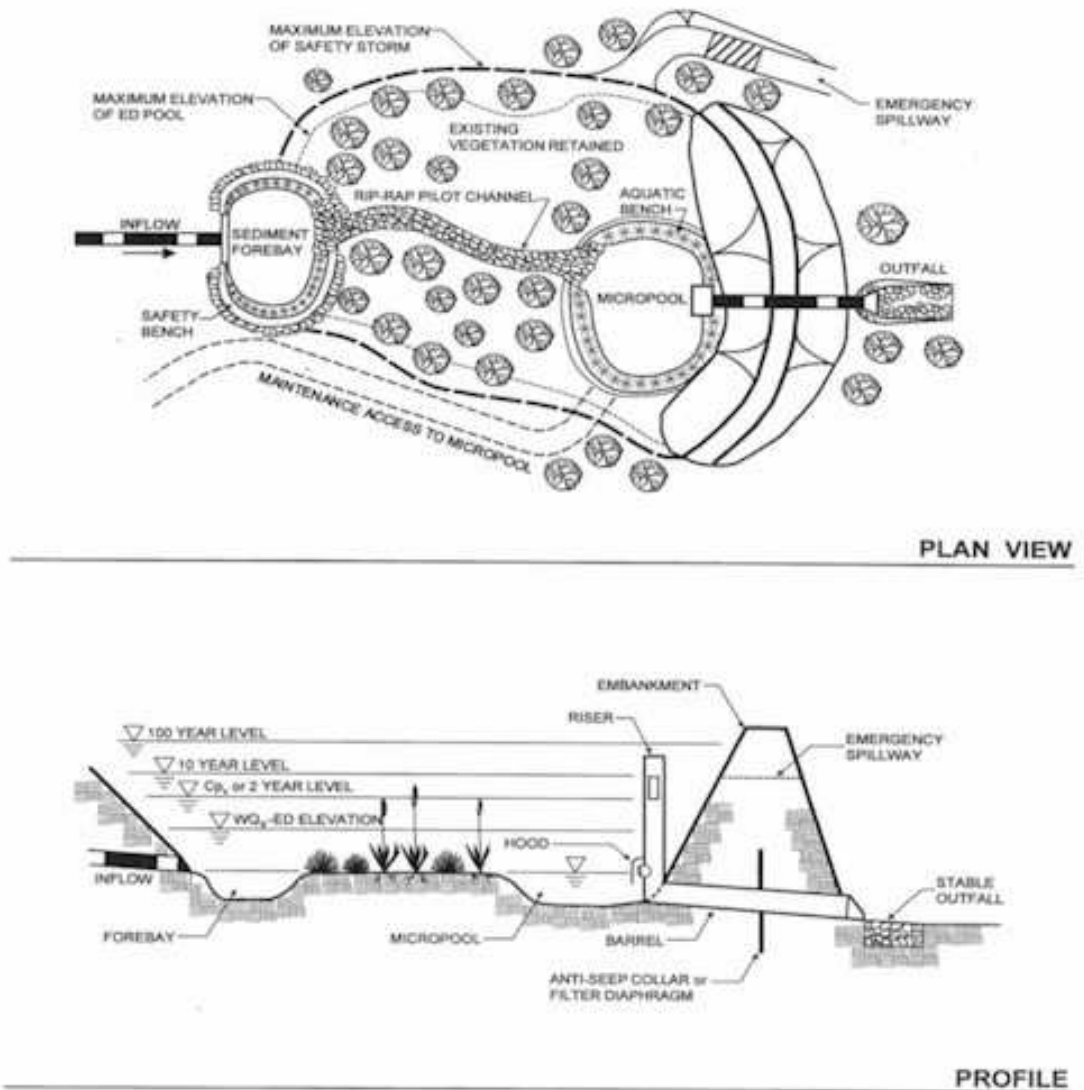
The basin outlet structure must be designed to detain runoff from the stormwater quality design storm for extended periods. Some volume reduction is also achieved in a dry basin through initial saturation of the soil mantle (even when compacted) and some evaporation takes place during detention. The net volume reduction for design storms is minimal, especially if the precedent soil moisture is assumed as in other volume reduction BMPs.

<p style="text-align: center;"><b><u>Key Design Elements</u></b></p> <ul style="list-style-type: none"> <li>▪ Evaluation of the device chosen should be balanced with cost</li> <li>▪ Hydraulic capacity controls effectiveness</li> <li>▪ Ideal in combination with other BMPs</li> <li>▪ Regular maintenance is necessary including periodic sediment removal</li> </ul>	<p style="text-align: center;"><b><u>Potential Applications</u></b></p> <p>Residential: Yes                  Commercial: Yes                  Ultra Urban: Yes                  Industrial: Yes                  Retrofit: Yes                  Highway/Road: Yes</p>
	<p style="text-align: center;"><b><u>Stormwater Functions</u></b></p> <p>Volume Reduction: Low                  Recharge: None                  Peak Rate Control: High                  Water Quality: Low</p>
	<p style="text-align: center;"><b><u>Water Quality Functions</u></b></p> <p>TSS: 60%                  TP: 40%                  NO3: 20%</p>

### Description

Dry extended detention basins are surface stormwater structures which provide for the temporary storage of stormwater runoff to prevent downstream flooding impacts. Water quality benefits may be achieved with extended detention of the runoff volume from the water quality design storm.

- The primary purpose of the detention basin is the attenuation of stormwater runoff peaks.
  - Detention basins should be designed to control runoff peak flow rates of discharge for the 1 year through 100 year events.
  - Inflow and discharge hydrographs should be calculated for each selected design storm. Hydrographs should be based on the 24-hour rainfall event.



- Basins should be designed to provide water quality treatment storage to capture the computed runoff volume of the water quality design storm.
  - Detention basins should have a sediment forebay or equivalent upstream pretreatment. The forebay should consist of a separate cell that is offline (so as to not resuspend sediment, formed by an acceptable barrier and will need periodic sediment removal.

- A micropool storage area should be designed where feasible for the extended detention of runoff volume from the water quality design storm.
- Flow paths from inflow points to outlets should be maximized.

## Variations

### Sub-surface extended detention

Extended detention storage can also be provided in a variety of sub-surface structural elements, such as underground vaults, tanks, large pipes or other structural media placed in an aggregate filled bed in the soil mantle. All such systems are designed to provide runoff peak rate mitigation as their primary function, but some pollutant removal may be included. Regular maintenance is needed, since the structure must be drained within a design period and cleaned to assure detention capacity for subsequent rainfall events. These facilities are usually intended for space-limited applications and are not intended to provide significant water quality treatment.

- Underground vaults are typically box shaped underground stormwater storage facilities constructed of reinforced concrete, while tanks are usually constructed of large diameter metal or plastic pipe. They may be situated within a building, but the use of internal space is frequently not cost beneficial.
  - Storage design and routing methods are the same as for surface detention basins.
  - Underground vaults and tanks do not provide water quality treatment and should be used in combination with a pretreatment BMP.
- Underground detention beds can be constructed by excavating a subsurface area and filling with uniformly graded aggregate for support of overlying land uses.
  - This approach may be used where space is limited but subsurface infiltration is not feasible due to high water table conditions or shallow soil mantle.
  - As with detention vaults and tanks, this facility provides minimal water quality treatment and should be used in combination with a pretreatment BMP.
  - It is recommended that underground detention facilities not be lined to allow for even minimal infiltration, except in the case where toxic contamination is possible.

## Applications

- **Low Density Residential Development**
- **Industrial Development**
- **Commercial Development**
- **Urban Areas**

## Design Considerations

### 1. Storage Volume, Depth and Duration

- a. Extended detention basins should be designed to mitigate runoff peak flow rates.
- b. An emergency outlet or spillway which is capable of conveying the spillway design flood (SDF) should be included in the design. The SDF is usually equal to the 100-year design flood
- c. Extended detention basins should be designed to treat the runoff volume produced by the water quality design storm.

- d. Extended Detention Basins are designed to achieve a specified detention time. Details on the detention time are outlined in Chapter 3.
- e. The lowest elevation within an extended dry detention basin should be at least 2 feet above the seasonal high water table. If high water table conditions are anticipated, then the design of a wet pond, constructed wetland or bioretention facility should be considered.

## 2. Dry Extended Detention Basin Location

- a. Extended detention basins should be located down gradient of disturbed or developed areas on the site. The basin should collect as much site runoff as possible, especially from the site's impervious surfaces (roads, parking, buildings, etc.).
- b. Extended detention basins should not be constructed on steep slopes, nor should slopes be significantly altered or modified to reduce the steepness of the existing slope, for the purpose of installing a basin.
- c. Extended detention basins should not worsen the runoff potential of the existing site by removal of trees for the purpose of installing a basin.
- d. Extended detention basins should not be constructed in areas with high quality and/or well draining soils, which are adequate for the installation of BMPs capable of achieving stormwater infiltration.
- e. Extended detention basins should not be constructed within jurisdictional waters, including wetlands.

## 3. Basin Sizing and Configuration

- a. Basins should be shaped to maximize the length of stormwater flow pathways and minimize short-circuited inlet-outlet systems. Basins should have a minimum width of 10 feet. A minimum length-to-width ratio of 2:1 is recommended to maximize sedimentation.
- b. Irregularly shaped basins are encouraged and appear more natural.
- c. If site conditions inhibit construction of a long, narrow basin, baffles constructed from earthen berms or other materials can be incorporated into the pond design to "lengthen" the stormwater flow path. Care should be taken to ensure the design storage capacity is provided after baffle installation.
- d. Low flow channels, if required, should always be vegetated with a maximum slope of 3 percent to encourage sedimentation. Alternatively, other BMPs may be considered such as wet ponds, constructed wetlands or bioretention.

## 4. Embankments

- a. Embankments should be less than 15 feet in height and should have side slopes no steeper than 3:1 (H:V).
- b. The basin should have a minimum freeboard of 1 foot above the SDF elevation.

## 5. Inlet Structures

- a. Inlet structures to basin should not be submerged at the normal pool depth.
- b. Erosion protection measures should be utilized to stabilize inflow structures and channels.

## 6. Outlet Design

- a. In order to meet design storm requirements, dry extended detention basins should have a multistage outlet structure. Three elements are typically included in this design:
  1. A low-flow outlet that controls the extended detention and functions to slowly release the water quality design storm.
  2. A primary outlet that functions to attenuate the peak of larger design storms.
  3. An emergency overflow outlet/spillway
- b. The primary outlet structure should incorporate weirs, orifices, pipes or a combination of these to control runoff peak rates for required design storms. Water quality storage should be provided below the invert of the primary outlet. When routing basins, the low-flow outlet should be included in the depth-discharge relationship.
- c. Energy dissipaters are to be placed at the end of the primary outlet to prevent erosion. If the basin discharges to a channel with dry weather flow, care should be taken to minimize tree clearing along the downstream channel and to reestablish a forested riparian zone between the outlet and natural channel. Where feasible, a multiple orifice outlet system is preferred to a single pipe.
- d. The orifice should typically be no smaller than 2.5 inches in diameter. However, the orifice diameter may be reduced to 1 inch if adequate protection from clogging is provided.
- e. The hydraulic design of all outlet structures should consider any tailwater effects of downstream waterways.
- f. The primary and low flow outlet should be protected from clogging by an external trash rack.

## 7. Sediment Forebay

- a. Forebays should be incorporated into the extended detention design. The forebay storage volume is included for the water quality volume requirement.
- b. Forebays should be vegetated to improve filtering of runoff, to reduce runoff velocity, and to stabilize soils against erosion. Forebays are typically constructed as shallow marsh areas and should adhere to the following design criteria:
  1. It is recommended that forebays have a minimum length of 10 feet.
  2. Storage should be provided to trap the anticipated sediment volume produced over a period of 2 years.
  3. Forebays should be protected from the erosive force of the inflow to prevent resuspension of previously collected sediment during large storms (typically constructed offline).



**8. Vegetation and Soils Protection**

- a. Care should be taken to prevent compaction of in situ soils in the bottom of the extended detention basin in order to promote healthy plant growth and to encourage infiltration. If soils compaction is not prevented during construction, soils should be restored as discussed in BMP 6.7.3 – Soils Amendment & Restoration.
- b. It is recommended that basin bottoms be vegetated in a diverse native planting mix to reduce maintenance needs, promote natural landscapes, and increase infiltration potential. Vegetation may include trees, woody shrubs and meadow/wetland herbaceous plants.
- c. Woody vegetation should not be planted on the embankments or within 25 feet of the emergency overflow spillway.
- d. Meadow grasses or other deeply rooted herbaceous vegetation is recommended on the interior slope of embankments.
- e. Fertilizers and pesticides should not be used.

**9. Special Design Considerations**

- a. Ponds that have embankments higher than 15 feet, have a drainage of more than 100 acres or will impound more that 50 acre-feet of runoff during the high-water condition will be regulated as dams by PADEP. The designer shall consult Pennsylvania Chapter 105 to determine which provisions may apply to the specific project in question.
- b. Extended detention ponds should not be utilized as recreation areas due to health and safety issues. Design features that discourage access are recommended.

**Detailed Stormwater Functions**

**Peak Rate Mitigation**

Inflow and discharge hydrographs should be calculated and routed for each design storm. Hydrographs should be based on a 24-hour rainfall event.



## Water Quality Improvement

Water quality mitigation is partially achieved by retaining the runoff volume from the water quality design storm for a minimum prescribed period as specified in Chapter 3. Sediment forebays should be incorporated into the design to improve sediment removal. The storage volume of the forebay may be included in the calculated storage of the water quality design volume.

## Construction Sequence

1. Install all temporary erosion and sedimentation controls.
  - a. The area immediately adjacent to the basin must be stabilized in accordance with the PADEP's *Erosion and Sediment Pollution Control Program Manual* (2000 or latest edition) prior to basin construction.
2. Prepare site for excavation and/or embankment construction.
  - a. All existing vegetation should remain if feasible and should only be removed if necessary for construction.
  - b. Care should be taken to prevent compaction of the basin bottom.
  - c. If excavation is required, clear the area to be excavated of all vegetation. Remove all tree roots, rocks, and boulders only in excavation area
3. Excavate bottom of basin to desired elevation (if necessary).
4. Install surrounding embankments and inlet and outlet control structures.
5. Grade subsoil in bottom of basin, taking care to prevent compaction. Compact surrounding embankment areas and around inlet and outlet structures.
6. Apply and grade planting soil.
7. Apply geo-textiles and other erosion-control measures.
8. Seed, plant and mulch according to Planting Plan
9. Install any anti-grazing measures, if necessary.

## Maintenance Issues

Maintenance is necessary to ensure proper functionality of the extended detention basin and should take place on a quarterly basis. A basin maintenance plan should be developed which includes the following measures:

- All basin structures expected to receive and/or trap debris and sediment should be inspected for clogging and excessive debris and sediment accumulation at least four times per year, as well as after every storm greater than 1 inch.
  - Structures include basin bottoms, trash racks, outlets structures, riprap or gabion structures, and inlets.
- Sediment removal should be conducted when the basin is completely dry. Sediment should be disposed of properly and once sediment is removed, disturbed areas need to be immediately stabilized and revegetated.
- Mowing and/or trimming of vegetation should be performed as necessary to sustain the system, but all detritus should be removed from the basin.
  - Vegetated areas should be inspected annually for erosion.
  - Vegetated areas should be inspected annually for unwanted growth of exotic/invasive species.
  - Vegetative cover should be maintained at a minimum of 95 percent. If vegetative cover has been reduced by 10%, vegetation should be reestablished.

## Cost Issues

The construction costs associated with dry extended detention basins can range considerably. One recent study evaluated the cost of all pond systems (Brown and Schueler, 1997). Before adjusting for inflation from 1997, the cost of dry extended detention ponds can be estimated with the equation:

$$C = 12.4V^{0.760}$$

Where:

C = Construction, Design and Permitting Cost

V = Volume needed to control the 10-year storm (cubic feet)

Using this equation, a typical construction costs (1997) are:

\$ 41,600 for a 1 acre-foot pond

\$ 239,000 for a 10 acre-foot pond

\$ 1,380,000 for a 100 acre-foot pond

Dry extended detention basins utilizing highly structural design features (rip-rap for erosion control, etc.) are more costly than naturalized basins. There is an installation cost savings associated with a natural vegetated slope treatment which is magnified by the additional environmental benefits provided. Long-term maintenance costs are reduced when more naturalized approaches are utilized due to the ability of native vegetation to adapt to local weather conditions and a reduced need for maintenance, such as mowing and fertilization.

Normal maintenance costs can be expected to range from 3 to 5 percent of the construction costs on an annual basis.

These costs don't include the cost or value of the property.

## Specifications

The following specifications are provided for information purposes only. These specifications include information on acceptable materials for typical applications, but are by no means exclusive or limiting. The designer is responsible for developing detailed specifications for individual design projects in accordance with the project conditions.

### 1. Site Preparation

- a. All excavation areas, embankments, and where structures are to be installed shall be cleared and grubbed as necessary, but trees and existing vegetation should be retained and incorporated within the dry detention basin area where possible.
- b. Where feasible, trees and other native vegetation should be protected. A minimum 10-foot radius around the inlet and outlet structures can be cleared to allow construction.
- c. Any cleared material should be used as mulch for erosion control or soil stabilization.
- d. Care should be taken to prevent compaction of the bottom of the reservoir. If compaction should occur, soils should be restored and amended.

### 2. Earth Fill Material & Placement

- a. The fill material should be taken from approved designated excavation areas. It should be free of roots, stumps, wood, rubbish, stones greater than 6 inches, or other

objectionable materials. Materials on the outer surface of the embankment must have the capability to support vegetation.

- b. Areas where fill is to be placed should be scarified prior to placement. Fill materials for the embankment should be placed in maximum 8-inch lifts. The principal spillway should be installed concurrently with fill placement and not excavated into the embankment.
- c. The movement of the hauling and spreading equipment over the site should be controlled. For the embankment, each lift should be compacted to 95% of the standard proctor. Fill material should contain sufficient moisture so that if formed in to a ball it will not crumble, yet not be so wet that water can be squeezed out.

### 3. Embankment Core

- a. The core should be parallel to the centerline of the embankment as shown on the plans. The top width of the core should be at least four feet. The height should extend up to at least the 10-year water elevation or as shown on the plans. The side slopes should be 1 to 1 or flatter. The core should be compacted with construction equipment, rollers, or hand tampers to assure maximum density and minimum permeability. The core should be placed concurrently with the outer shell of the embankment.

### 4. Structure Backfill

- a. Backfill adjacent to pipes and structures should be of the type and quality conforming to that specified for the adjoining fill material. The fill should be placed in horizontal layers not to exceed four inches in thickness and compacted by hand tampers or other manually directed compaction equipment. The material should fill completely all spaces under and adjacent to the pipe. At no time during the backfilling operation should driven equipment be allowed to operate closer than four feet to any part of the structure. Equipment should not be driven over any part of a concrete structure or pipe, unless there is a compacted fill of 24 inches or greater over the structure or pipe.
- b. Structure backfill may be flowable fill meeting the requirements of the PADOT Standard Specifications for Construction. Material should be placed so that a minimum of 6 inches of flowable fill should be under (bedding), over and, on the sides of the pipe. It only needs to extend up to the spring line for rigid conduits. Average slump of the fill material should be 7 inches to assure flowability of the mixture. Adequate measures should be taken (sand bags, etc.) to prevent floating the pipe. When using flowable fill all metal pipe should be bituminous coated. Adjoining soil fill should be placed in horizontal layers not to exceed 4 inches in thickness and compacted by hand tampers or other manually directed compaction equipment.
- c. Refer to Chapter 220 Of PennDot Pub. 408 (2000).

### 5. Rock Riprap

- a. Rock riprap should meet the requirements of Pennsylvania Department of Transportation Standard Specifications.

### 6. Stabilization

- a. All borrow areas should be graded to provide proper drainage and left in a slightly condition. All exposed surfaces of the embankment, spillway, spoil and borrow areas, and berms should be stabilized by seeding, planting and mulching.

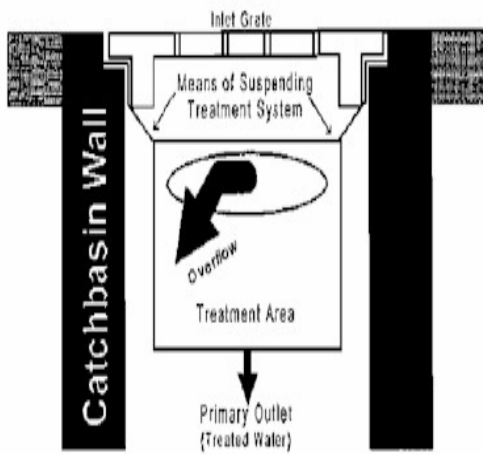
### 7. Operation and Maintenance

- a. An operation and maintenance plan in accordance with Local or State Regulations will be prepared for all basins. As a minimum, a dam and inspection checklist should be included as part of the operation and maintenance plan and performed at least annually.

## References

- AMEC Earth and Environmental Center for Watershed Protection et al. *Georgia Stormwater Management Manual*. 2001.
- Brown, W. and T. Schueler. 1997. *The Economics of Stormwater BMPs in the Mid-Atlantic Region*. Prepared for: Chesapeake Research Consortium. Edgewater, MD. Center for Watershed Protection. Ellicott City, MD.
- California Stormwater Quality Association. *California Stormwater Best Management Practices Handbook: New Development and Redevelopment*. 2003.
- CH2MHILL. *Pennsylvania Handbook of Best Management Practices for Developing Areas*. 1998.
- Chester County Conservation District. *Chester County Stormwater BMP Tour Guide-Permanent Sediment Forebay*, 2002.
- Commonwealth of PA, Department of Transportation. *Pub 408 - Specifications*. 1990. Harrisburg, PA. Maryland Department of the Environment. *Maryland Stormwater Design Manual*. 2000.
- Milner, George R. 2001. *Conventional vs. Naturalized Detention Basins: A Cost/Benefit Analysis*. Prepared for: The Illinois Association for Floodplain and Stormwater Management. Park Forest, IL
- New Jersey Department of Environmental Protection. *New Jersey Stormwater Best Management Practices Manual*. 2004.
- Stormwater Management Fact Sheet: Dry Extended Detention Pond – [www.stormwatercenter.net](http://www.stormwatercenter.net)
- Vermont Agency of Natural Resources. *The Vermont Stormwater Management Manual*. 2002.
- Washington State Department of Ecology. *Stormwater Management Manual for Eastern Washington (Draft)*. Olympia, WA: 2002.

## BMP 6.6.4: Water Quality Filters & Hydrodynamic Devices



A broad spectrum of BMPs have been designed to remove non point source pollutants from runoff as a part of the runoff conveyance system. These structural BMPs vary in size and function, but all utilize some form of settling and filtration to remove particulate pollutants from stormwater runoff, a difficult task given the concentrations and flow rates experienced. Regular maintenance is critical for this BMP. Many water quality filters, catch basin inserts and hydrodynamic devices are commercially available. They are generally configured to remove particulate contaminants, including coarse sediment, oil and grease, litter, and debris.

<p style="text-align: center;"><b><u>Key Design Elements</u></b></p> <ul style="list-style-type: none"> <li>▪ Choose a device that (collectively) has the hydraulic capacity to treat the design storm</li> <li>▪ Evaluation of the device chosen should be balanced with cost</li> <li>▪ Hydraulic capacity controls effectiveness</li> <li>▪ Most useful in small drainage areas (&lt; 1 Acre)</li> <li>▪ Ideal in combination with other BMPs</li> <li>▪ Regular maintenance is necessary</li> </ul>	<p style="text-align: center;"><b><u>Potential Applications</u></b></p> <p>Residential: Yes                  Commercial: Yes                  Ultra Urban: Yes                  Industrial: Yes                  Retrofit: Yes                  Highway/Road: Yes</p>
	<p style="text-align: center;"><b><u>Stormwater Functions</u></b></p> <p>Volume Reduction: None                  Recharge: None                  Peak Rate Control: None                  Water Quality: Medium</p>
	<p style="text-align: center;"><b><u>Water Quality Functions</u></b></p> <p>TSS: 60%                  TP: 50%                  NO3: 20%</p>

**Other Considerations**

- See Manufacturers specifications for estimated pollutant removal efficiencies.

## Description

Water Quality Inlets are stormwater inlets that have been fitted with a proprietary product (or the proprietary product replaces the catch basin itself). They are designed to reduce large sediment, suspended solids, oil and grease, and other pollutants, especially pollutants conveyed with sediment transport. They can provide “hotspot” control and reduce sediments loads to infiltration devices. They are commonly used as pretreatment for other BMPs. The manufacturer usually provides the mechanical design, construction, and installation instructions. Selection of the most appropriate device and development of a maintenance plan should be carefully considered by the Designer.

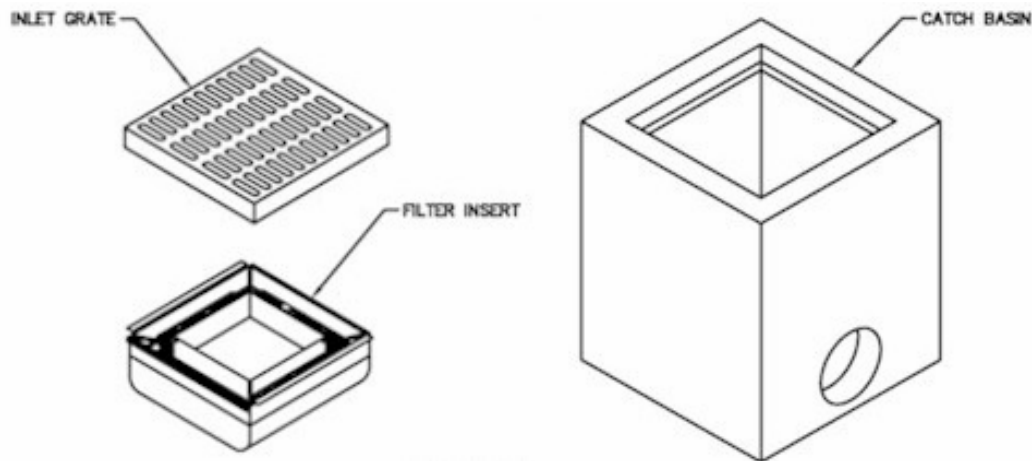
The size of a water quality inlet limits the detention time and the hydraulic capacity influences the effectiveness of the water quality insert. Most products are designed for an overflow in large storm events, which is necessary hydraulically and still allows for a “first flush” treatment.

Regular maintenance according to application and manufacturer’s recommendations is essential for continued performance.

## Variations

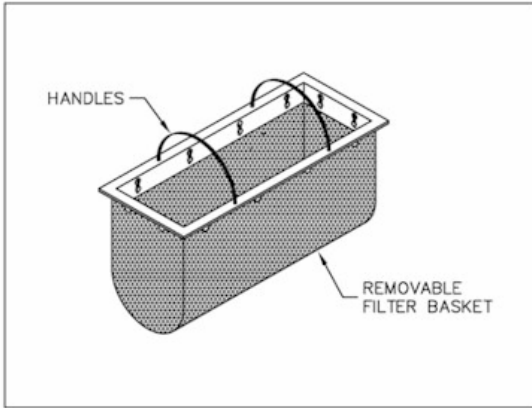
### Tray types

Allows flow to pass through filter media that is contained in a tray located around the perimeter of the inlet. Runoff enters the tray and leaves via weir flow under design conditions. High flows pass over the tray and into the inlet unimpeded.



**Bag types**

Insert is made of fabric and is placed in the drain inlet around the perimeter of the grate. Runoff passes through the bag before discharging into the drain outlet pipe. Overflow holes are usually provided to pass larger flows without causing a backwater at the grate. Certain manufactured products include polymers intended to increase pollutant removal effectiveness.



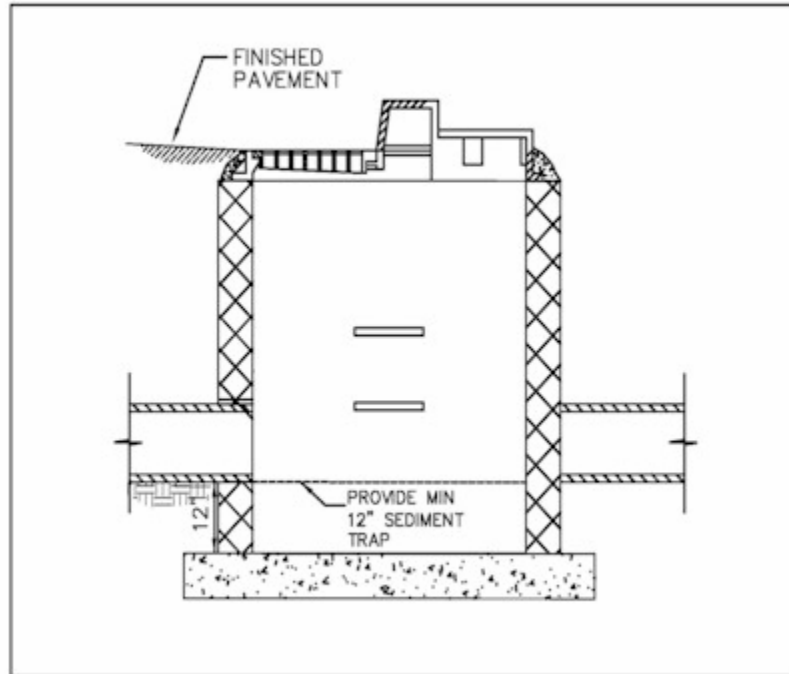
**Basket types**

The insert consists of “basket type” insert that sets into the inlet and has a handle to remove basket for maintenance. Small orifices allow small storm events to weep through, while larger storms overflow the basket. Primarily useful for debris and larger sediment, and requires consistent and frequent maintenance.



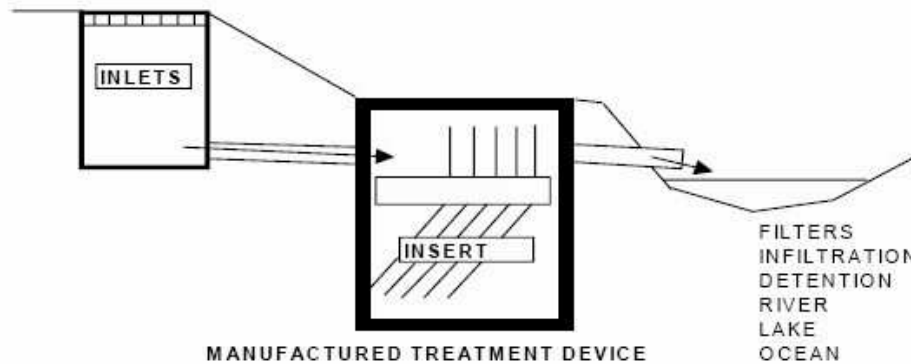
**Simple, “sumps” in inlets**

Space created in inlets below the invert of the pipes for sediment and debris to deposit, usually leaving 6-inches to 12-inches at the bottom of an inlet. Small weep holes should be drilled into the bottom of the inlet to prevent standing water for long periods of time. Regular maintenance is required.



**Description - Hydrodynamic Devices**

Hydrodynamic Devices are not truly inserts, but separate flow through devices designed to serve in concert with inlets and storm sewer. A variety of products are available from different manufacturers. The primary purpose is to use various methods to remove sediments and pollutants. These methods include baffle plate design, vortex design, tube settler design, inclined plate settler design or a combination of these. Ideally, the flow through device should remove litter, oil, sediment, heavy metals, dissolved solids and nutrients. Removal ability varies as a result of loading rate and design. Clays and fine silts do not easily settle out unless they are coagulated with some kind of chemical addition or polymer. These devices work most effectively in combination with other BMPs, either as a pre-treatment or as a final treatment at the end of a pipe.





## Applications

Any existing or proposed inlet where the contributing runoff may contain significant levels of sediment and debris, for example: parking lots, gas stations, golf courses, streets, driveways, industrial or commercial facilities, and municipal corporation yards. Commonly used as pretreatment before other stormwater BMPs.

## Design Considerations

1. Match site considerations with manufacturer's guidelines/specifications (i.e. land use will determine specific pollutants to be removed from runoff).
2. Prevent re-suspension of particles by using small drainage areas and good maintenance.
3. Retrofits should be designed to fit existing inlets.
4. Placement should be accessible to maintenance.
5. If used as part of Erosion & Sedimentation Control during construction, insert should be reconfigured (if necessary) per manufacture's guidelines.
6. Overflow should be designed so that storms in excess of the device's hydraulic capacity bypass the treatment and is treated by another quality BMP.

## Detailed Stormwater Functions

### Volume Reduction Calculations

N/A

### Peak Rate Mitigation Calculations

N/A

### Water Quality Improvement

See manufacturers specifications and tests.

## Construction Sequence

1. Stabilize all contributing areas before installing and connecting pipes to these inlets.
2. Follow manufacturer's guidelines for installation. Do not use water quality inserts during construction unless product is designed primarily for sediment removal. (Some products have adsorption components that should be installed post-construction.)

## Maintenance Issues

Follow the manufacturer's guidelines for maintenance, also taking into account expected pollutant load and site conditions. Inlets should be inspected weekly during construction. Post-construction, they should be emptied when over half full of sediment (and trash) and cleaned at least twice a year. They

should also be inspected after runoff events. Maintenance is crucial to the effectiveness of this BMP. The more frequent a water quality insert is cleaned, the more effective it will be. One study (Pitt, 1985) found that WQI's can store sediment up to 60% of its sump volume, and after that, the inflow resuspends the sediments into the stormwater. Some sites have found keeping a log of sediment amount date removed helpful in planning a maintenance schedule. Environmental Technology Verification (ETV) Program and the Technology Acceptance and Reciprocity Partnership (TARP) may be available to assist with the development of a monitoring plan. These programs are detailed in Section 6.3.



Disposal of removed material will depend on the nature of the drainage area and the intent and function of the water quality insert. Material removed from water quality inserts that serve "Hot Spots" such as fueling stations or that receive a large amount of debris should be handled according to DEP regulations for that type of solid waste, such as a landfill that is approved by DEP to accept solid waste. Water quality inserts that primarily catch sediment and detritus from areas such as lawns may reuse the waste on site.

Vactor trucks may be an efficient cleaning mechanism.

Winter Concerns: There is limited data studying cold weather effects on water quality insert effectiveness. Freezing may result in more runoff bypassing the treatment system. Salt stratification may also reduce detention time. Colder temperatures reduce the settling velocity of particles, which can result in fewer particles being "trapped". Salt and sand are significantly increased in the winter, and may warrant more frequent maintenance. Sometimes freezing makes accessing devices for maintenance difficult.

## Cost Issues

Check with manufacturers for current prices.

## Specifications

Follow manufacturer's instructions and specific specifications.

## References

Brzozowski, C., 2003. "Inlet Protection – Strategies for Preserving Water Quality," Stormwater magazine.

Lee, F. "The Right BMPs? Another Look at Water Quality." Stormwater magazine.

New Hampshire Watershed Management Bureau, Watershed Assistance Section, 2002. "Innovative Stormwater Treatment Technologies BMP Manual."

Pitt, R. *Characterizing and Controlling Urban Runoff through Street and Sewerage Cleaning*. US EPA, June 1985.

## 6.7 Restoration BMPs



## BMP 6.7.1: Riparian Buffer Restoration



A riparian buffer is a permanent area of trees and shrubs located adjacent to streams, lakes, ponds, and wetlands. Riparian forests are the most beneficial type of buffer for they provide ecological and water quality benefits. Restoration of this ecologically sensitive habitat is a responsive action to past activities that may have eliminated any vegetation.

<p style="text-align: center;"><b><u>Key Design Elements</u></b></p> <ul style="list-style-type: none"> <li>▪ Reestablish buffer areas along perennial, intermittent, and ephemeral streams</li> <li>▪ Plant native, diverse tree and shrub vegetation</li> <li>▪ Buffer width is dependant on project preferred function (water quality, habitat creation, etc.)</li> <li>▪ Minimum recommended buffer width is 35' from top of stream bank, with 100' preferred.</li> <li>▪ Create a short-term maintenance and long-term maintenance plan</li> <li>▪ Mature forest as a vegetative target</li> <li>▪ Clear, well-marked boundary</li> </ul>	<p style="text-align: center;"><b><u>Potential Applications</u></b></p> <p>Residential: Yes                  Commercial: Yes                  Ultra Urban: Yes                  Industrial: Yes                  Retrofit: Yes                  Highway/Road: Limited</p>
	<p style="text-align: center;"><b><u>Stormwater Functions</u></b></p> <p>Volume Reduction: Medium                  Recharge: Medium                  Peak Rate Control: Low/Med.                  Water Quality: Med./High</p>
	<p style="text-align: center;"><b><u>Water Quality Functions</u></b></p> <p>TSS: 65%                  TP: 50%                  NO3: 50%</p>

## Description

The USDA Forest Service estimates that over one-third of the rivers and streams in Pennsylvania have had their riparian areas degraded or altered. This fact is sobering when one considers the important stormwater functions that riparian buffers provide. The non-structural BMP, Riparian Forest Buffer Protection, addresses the importance of protecting the three-zone system of existing riparian buffers.

The values of riparian buffers – economic, environmental, recreational, aesthetic, etc. – are well documented in scientific literature and numerous reports and thus will not be restated here in this BMP sheet. Rather, this BMP serves to provide a starting point for the designer that seeks to restore the riparian buffer. Important reports are cited consistently throughout this section and should be mentioned upfront as sources for additional information to a designer seeking to restore a riparian buffer. The first, the *Chesapeake Bay Riparian Handbook: a Guide for Establishing and Maintaining Riparian Forest Buffers* was prepared by the US Department of Agriculture (USDA) Forest Service for the Chesapeake Bay Program in 1997. The second, the *Pennsylvania Stream ReLeaf Forest Buffer Toolkit* was developed by the Alliance for the Chesapeake Bay specifically for the Pennsylvania streams in 1998. A third and often-referenced report, is the *Riparian Forest Buffers* series written by Robert Tjaden for the Maryland Cooperative Extension Service in 1998.

Riparian buffers are scientifically proven to provide a number of economic and environmental values. Buffers are characterized by high species density, high species diversity, and high bio-productivity as a transition between aquatic and upland environments. Project designers should take into account the benefits or services provided by the buffer and apply these to their project goals. Priorities for riparian buffer use should be established early on in the planning stages. Some important considerations when establishing priorities are:

- **Habitat** – Restoring a buffer for habitat enhancement will require a different restoration strategy than for restoring a buffer for increased water quality.
- **Stream Size** – A majority of Pennsylvania’s stream miles is comprised of small streams (first, second, and third order), which may be priority areas to reduce nutrients. Establishing riparian buffers along these headwater streams will reduce the high nutrient loads relative to flow volumes typical of small streams.
- **Continuous Buffers** - Establishing continuous riparian forest buffers in the landscape should be given a higher priority than establishing larger but fragmented buffers. Continuous buffers provide better stream shading and water quality protection, as well as corridors for the movement of wildlife.
- **Degree of Degradation** – Urban streams are usually buried or piped. Streams in areas without forests, such as pastures, may benefit the most from buffer restoration, as sources of headwater streams. Highly urbanized/altered streams may not be able to provide high levels of pollution control.
- **Loading Rates** - The removal of pollutants may be highest where nutrient and sediment loading are the highest.
- **Land Use** – Adjacent land uses will influence Buffer Width and Vegetation types used to establish a riparian buffer. While the three-zone riparian-forested buffers described earlier are the ideal, they may not always be feasible to establish, especially in urban situations.

Preparation of a *Riparian Buffer Restoration Plan* is critical to ensuring long-term success of the project and should be completed before any planting is to occur. It is essential that site conditions are well understood, objectives of the landowner are considered, and the appropriate plants chosen for the site, tasks that are completed in the planning stages. Below is a summary of the nine steps that are recommended for the planning stages of a buffer restoration project.

### 1. Obtain Landowner Permission and Support

Landowner commitment is essential for the success of the project. Landowners must be aware of all maintenance activities that will occur once buffer is planted.

### 2. Make Sure Site is Suitable for Restoration

If streambanks are extensively eroded, consider an alternative location. Rapidly eroding streambanks may undermine seedlings. Streambank restoration may need to occur prior to riparian buffer restoration. Obtain professional help in evaluating the need for streambank restoration.

### 3. Analyze Site's Physical Conditions

The most important physical influence of the site is the soil, which will control plant selection. Evaluate the soil using the County soil survey book to determine important soil characteristics such as flooding potential, seasonal high water table, topography, soil pH, soil moisture, etc. Also, a simple field test can suffice, with direct observation of soil conditions.

### 4. Analyze Site's Vegetative Features

Existing vegetation present at the restoration site should be examined to determine the strategy for buffer establishment. Strategies will differ for various pre-restoration conditions such as pasture, overgrown abandoned field, mid-succession forest, etc.

- *Identify Desirable Species:* Native tree and shrub species that thrive in riparian habitats in Pennsylvania should be used. These species should be identified in the restoration site and protected for their seed bank potential. Several native vines and shrubs (blackberry, Virginia creeper, and spicebush) can provide an effective ground cover during establishment of the buffer, though they should be selectively controlled to minimize herbaceous competition.
- *Identify Undesirable Species:* Consider utilizing undesirable species such as the black locust for their shade function during buffer establishment. Consider controlling invasive plants prior to buffer planting.
- *Identify Sensitive Species:* Since riparian zones are rich in wildlife habitat and wetland plant species to be aware of any rare, threatened or endangered plant (or animal) species.

### 5. Draw a Map of the Site (Data collection)

Prepare a sketch of the site that denotes important existing features, including stream width, length, streambank condition, adjacent land uses and stream activities, desired width of buffer, discharge pipes, obstructions, etc.

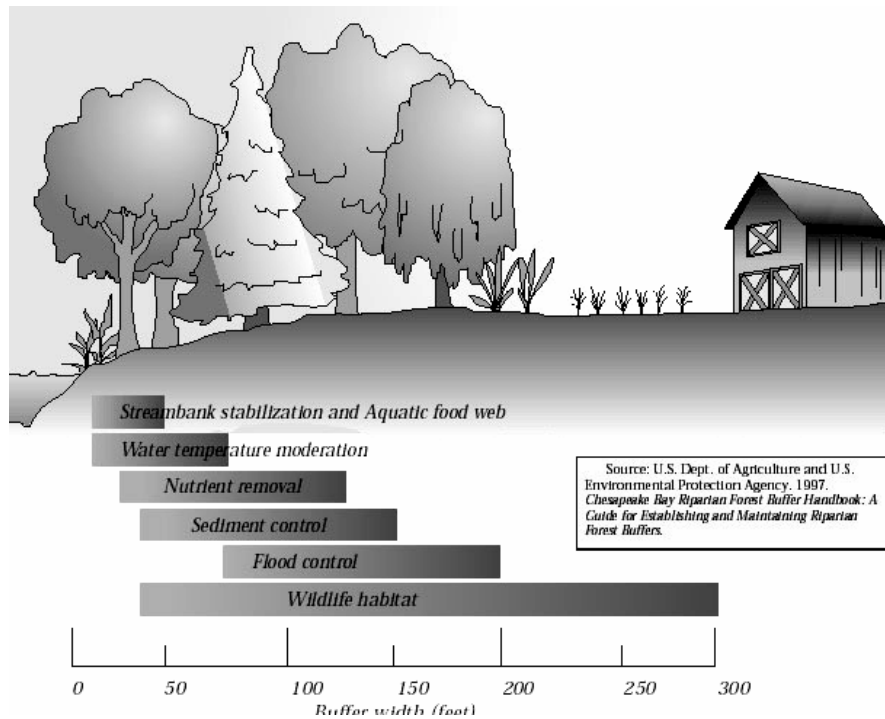
### 6. Create a Design that Meets Multiple Objectives

Ideally, the three-zone system should be incorporated into the design, in a flexible manner to obtain water quality and landowner objectives.

- *Consider landowner objectives:* Consider the current use of the buffer by the landowner, especially if the buffer will be protected in perpetuity. Consider linking the buffer to an existing (or planned) trail system.
- *Buffer width:* Riparian buffer areas do not have a fixed linear boundary, but vary in shape, width, and vegetative type and character. The function of the buffer (habitat, water quality, etc) is the overriding criterion in determining buffer width (Figure 1). Many factors including slope, soil type, adjacent land uses, floodplain, vegetative type, and

water shed condition influence what can be planted. The most commonly approved minimum buffer widths for water quality and habitat maintenance are 35 –100 feet. Buffers less than 35 feet do not protect aquatic resources long term.

Figure 1



- *Consider costs:* The planting design (density, type, mix, etc.) will ultimately be based on the financial constraints of the project. See discussion below for estimating direct costs for planting and maintenance.
- *Choose the appropriate plants:* This manual encourages the use of native plants in stormwater management facilities. Since they are best suited to our local climate, native species have distinct genetic advantages over non-native species. Ultimately using native plants translates into greater survivorship with less replacement and maintenance which is a cost benefit to the landowner. Please refer to the plant list in Appendix B for a comprehensive list of native trees and shrubs available for stormwater management facility planting.

**Plant Size:** Choice of planting stock (seeds, container seedling, bare-root seedlings, plugs, etc.) is ultimately determined by funding resources. Larger material will generally cost more, although it will usually establish more rapidly.



**7. Draw a Planting Plan**

*Planting Density:* Trees should be planted at a density sufficient to provide 320 trees per acre at maturity. To achieve this density, approximately 436 (10 x 10 feet spacing) to 681 (8 x 8 feet spacing) trees per acre should be planted initially. Some rules of thumb for tree spacing and density based on plant size at installation:

- Seedlings                      6-10 feet spacing (~700 seedlings / acre)
- Bare Root Stock            14-16 feet spacing (~200 plants / acre)
- Larger & Container        16 – 18 feet spacing (~150 plants/acre)

Formula for Estimating Number of Trees and Shrubs:  
 # Plants = length x width of corridor (ft) / 50 square feet

This formula assumes each tree will occupy an average of 50 sq. ft., random placement of plants approximately 10 feet apart, and mortality rate of up to 40% that can be absorbed by the growing forest system.

Alternatively, the adjacent table can be utilized to estimate the number of trees per acre needed for various methods of spacing.

*Planting Layout:* Given planting density and mix, drawing the planting plan is fairly straightforward. The plan can vary from a highly technical drawn to scale plan, or a simple line drawing of the site. Any plan must show the site with areas denoted for trees and shrub species with notes for plant spacing and buffer width.

Spacing (feet)	Trees (number)	Spacing (feet)	Trees (number)	Spacing (feet)	Trees (number)
2x2	10,890	7x9	691	12x15	242
3x3	4,840	7x10	622	12x18	202
4x4	2,722	7x12	519	12x20	182
4x5	2,178	7x15	415	12x25	145
4x6	1,815	8x8	681	13x13	258
4x7	1,556	8x9	605	13x15	223
4x8	1,361	8x10	544	13x20	168
4x9	1,210	8x12	454	13x25	134
4x10	1,089	8x15	363	14x14	222
5x5	1,742	8x25	218	14x15	207
5x6	1,452	9x9	538	14x20	156
5x7	1,245	9x10	484	14x25	124
5x8	1,089	9x12	403	15x15	194
5x9	968	9x15	323	15x20	145
5x10	871	10x10	436	15x25	116
6x6	1,210	10x12	363	16x16	170
6x7	1,037	10x15	290	16x20	136
6x8	908	10x18	242	16x25	109
6x9	807	11x11	360	18x18	134
6x10	726	11x12	330	18x20	121
6x12	605	11x15	264	18x25	97
6x15	484	11x20	198	20x20	109
7x7	889	11x25	158	20x25	87
7x8	778	12x12	302	25x25	70

**8. Prepare Site Ahead of Time**

Existing site conditions will determine the degree of preparation needed prior to planting. Invasive infestation and vegetative competition are extremely variable, and therefore must be considered in the planning stages. Site preparation should begin in the fall prior to planting. Enlist professional to determine whether use of chemical controls are necessary to prepare site for planting. Eliminate undesired species with either herbicide application (consult a professional) or physical removal. If utilizing a highly designed planting layout, mark site ahead of time with flags, spray paint, or other markers so that the appropriate plant is put in the right place.

**9. Determine Maintenance Needs**

An effective buffer restoration project should include management and maintenance guidelines, including a description of the allowable uses in the various zones of the buffer. Buffer

boundaries should be well defined with clear signs or markers. Weed control is essential for the survival and rapid growth of trees and shrubs, and can include any of the following:

- Organic mulch
- Weed control fabrics
- Shallow cultivation
- Pre-emergent herbicides
- Mowing

Non-chemical weed control methods are preferred since chemicals can easily enter the water system. If possible, avoid working in the riparian area between April 15 and August 15, the mating and newborn period for local wildlife.

**Variations**

See Applications

**Applications**

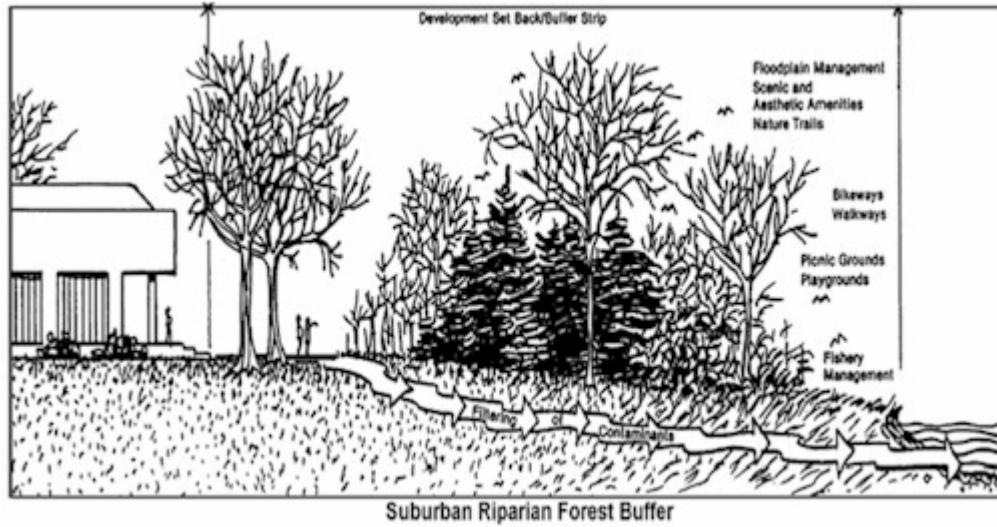
- **Forested Landscape**



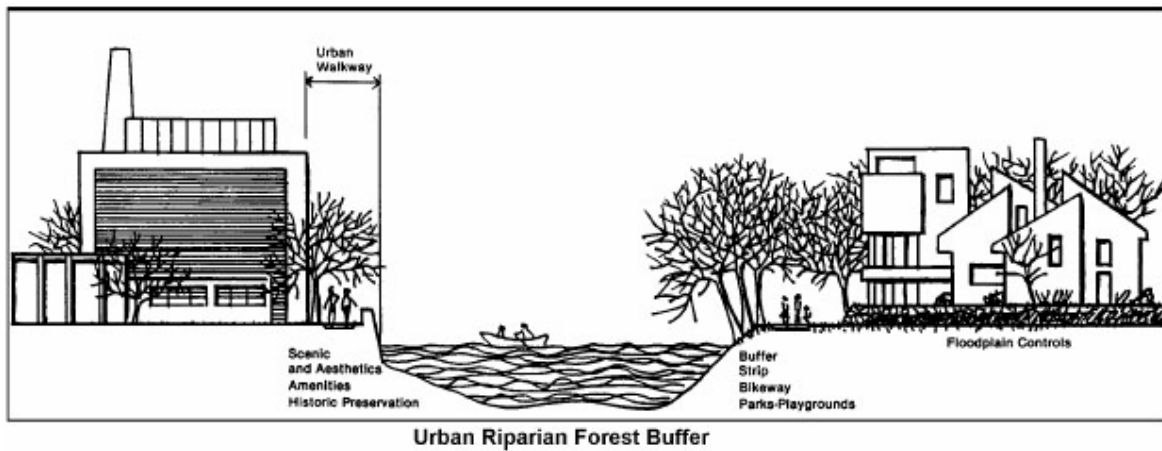
- **Agricultural Landscape**



- **Suburban / Developing Landscape**



- **Urban Landscape**



## Design Considerations

The considerations listed below should all be taken into account during the planning stage. There are many potential threats to the long-term viability of riparian plant establishment and with proper foresight, these problems can be eliminated or addressed.

### 1. Deer Control

- a. Look for signs of high deer densities, including an overgrazed understory with a browse line 5-6 feet above the ground.

### 2. Tree Shelters

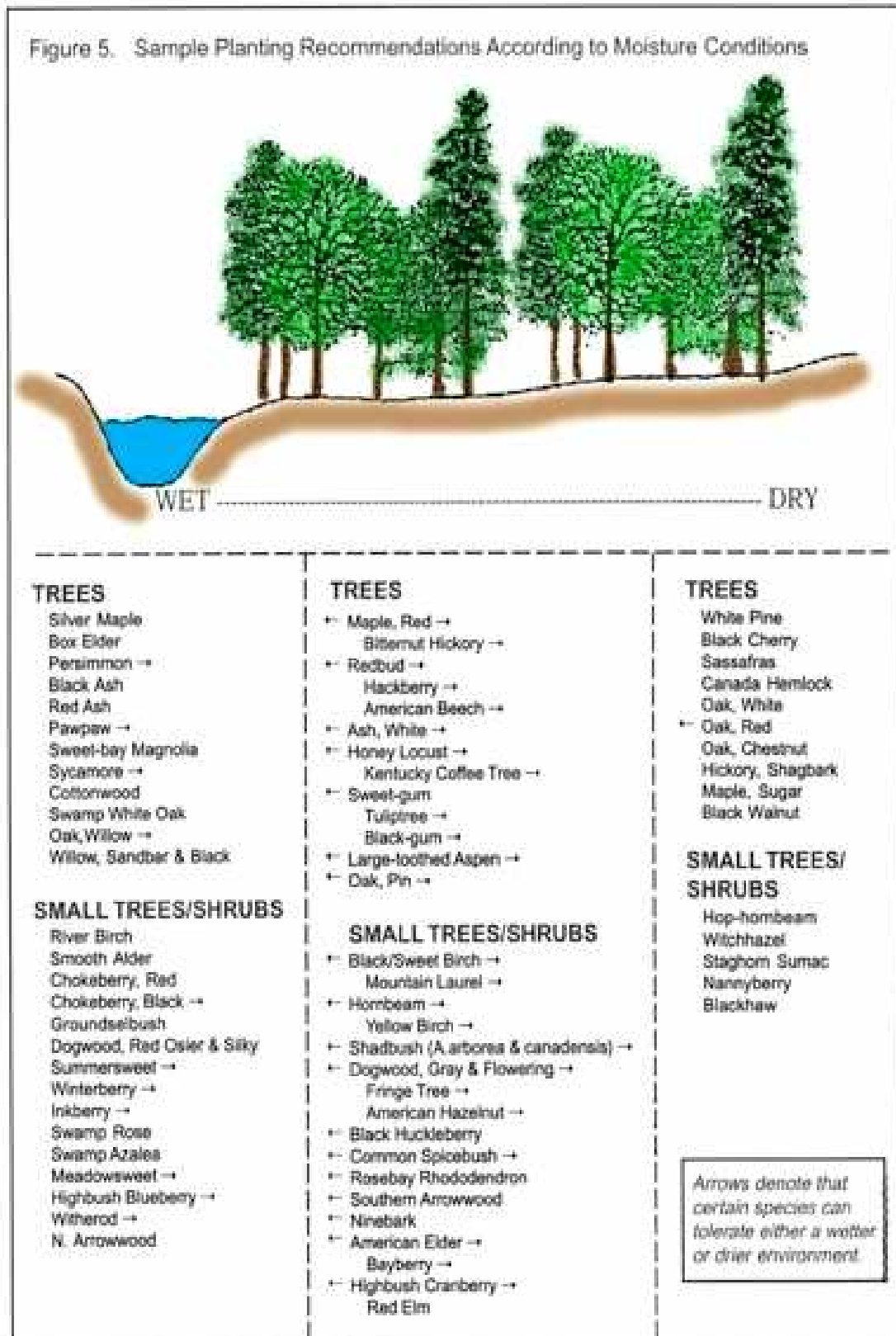
- a. Recommended for riparian plantings where deer predation or human intrusion may be a problem.
- b. Plastic tubes that fit over newly planted trees that are extremely successful in protecting seedlings.
- c. Protect trees from accidental strikes from mowing or trimming
- d. Create favorable microclimate for seedlings
- e. Secure with wooden stake and place netting over top of tree tube
- f. Remove tree shelters 2 to 3 years after plants emerge

### 3. Stream Buffer Fencing

- a. Deer can jump fences up to 10 feet high, preferring to go under barriers.
- b. Farm animals cause greatest damage to stream banks – consider permanent fencing like high-tensile smooth wire fencing or barbed fencing.
- c. The least expensive is 8 foot plastic fencing, which are effective against deer and easily repaired.

### 4. Vegetation

- a. Consider using plants that are able to survive frequent or prolonged flooding conditions. Plant trees that can withstand high water table conditions. Figure 5 shows tree species that fit into the moisture conditions of a streamside area.
- b. Soil disturbance can result in unanticipated infestation by invasive plants.



## Construction Sequence

The PA Stream ReLeaf project provides a checklist that can substitute for a construction sequence for riparian buffer restoration. A slightly modified version follows:

### 1. SELECT SITE

- Confirm site is suitable for restoration
- Obtain landowner permission

### 2. ANALYSE SITE

- Evaluate site's physical conditions (soil attributes, geology, terrain)
- Evaluate site's vegetative features (desirable and undesirable species, native species, sensitive habitats)
- Sketch or map site feature

### 3. DESIGN BUFFER

- Consider landowner objectives in creating buffer design
- Determine desired functions of buffer in determining buffer width
- Match plant species to site conditions (hardiness zone, moisture, soil pH)
- Match plant Species to objectives of buffer functions (water quality, wildlife, recreation, etc.)
- Match plant sizes to meet budget limitations
- Develop sketch of planting plan

### 4. PREPARE SITE

- Eliminate undesirable species ahead of planting date
- Mark planting layout at the site
- Purchase plants and planting materials (mulch, tree shelters)

### 5. SITE PLAN SHOULD INCLUDE:

- Site map with marked planting zones
- Plant species list
- Planting directions (spacing, pattern of planting)
- Equipment/tool list
- Site preparation directions
- Maintenance schedule

### 6. PLANTING DAY

- Keep plants moist and shaded
- Provide adequate number of tools
- Document with photos of site during planting

## 7. SITE MAINTENANCE (additional information below)

- Assign responsibilities watering, weeding, mowing, and maintenance
- Monitor site regularly for growth and potential problems

### **Maintenance Issues**

The riparian buffer is subject to many threats, including:

- Browsing
- Invasion by exotic species
- Competition for nutrients by adjacent herbaceous vegetation
- Human disturbance

Proper awareness of these issues is critical to ensure the long-term effectiveness of a restored riparian buffer.

The most critical period during buffer establishment is maintenance of the newly planted trees during canopy closure, typically the first 3 to 5 years. Ongoing maintenance practices are necessary for both small seedlings and larger plant materials. Maintenance and monitoring plans should be prepared for the specific site and caretakers need to be advised of required duties during the regular maintenance period.

Maintenance measures that should be performed regularly:

#### Watering

- Plantings need deep regular watering during the first growing season, either natural watering via rainfall, or planned watering, via caretaker.
- Planting in the fall increases the likelihood of sufficient rain during planting establishment.

#### Mulching

- Mulch will assist in moisture retention in the root zone of plantings, moderate soil temperature, provide some weed suppression, and retard evaporation
- Use coarse, organic mulch that is slow to decompose in order minimize repeat application
- Apply 2-4 inch layer, leaving air space around tree trunk to prevent fungus growth.
- Use combination of woodchips, leaves, and twigs that are stockpiled for six months to a year.

#### Weed control

- Weed competition limits buffer growth and survival, therefore weeds should be controlled by either herbicides, mowing, or weed mats:

#### **Herbicides**

This is a short-term maintenance technique (2-3 years) that is generally considered less expensive and more flexible than mowing, and will result in a quicker establishment of the buffer. Herbicide use is regulated by the PA Department of Agriculture. Proper care should be taken to ensure that proximity to water features is considered.

**Mowing**

Mowing controls the height of the existing grasses, yet increases nutrient uptake, therefore competition for nutrients will persist until the canopy closure shades out lower layers. A planting layout similar to a grid format will facilitate ease of mowing yet yield an unnaturally spaced community. Mowing may result in strikes on the trunk unless protective measures are utilized. Mowing should occur twice each growing season. Mower height should be set between 8 –12 inches.

**Weed Mats**

Weed mats are geo-textile fabrics that are used to suppress weed growth around newly planted vegetation by providing shade and preventing seed deposition. Weed mats are installed after planting, and should be removed once the trees have developed a canopy that will naturally shade out weeds.

**Deer damage**

- Deer will browse all vegetation within reach, generally between 5-6 feet above the ground
- Approaches to minimize damage include: 1) selecting plants that deer do not prefer (ex. Paper Birch, Beech, Ash, Common Elderberry) 2) homemade deer repellants 3) tree shelters

**Tree shelters**

- Repair broken stakes
- Tighten stake lines
- Straighten leaning tubes
- Clean debris from tube
- Remove netting as tree grows
- Remove when tree is approximately 2 inches wide

**Invasive Plants**

- Monitor restoration sight regularly for any signs of invasive plants.
- Appendix B contains common invasive plants found in Pennsylvania.
- Choice of control method is based on a variety of considerations, but falls into three general categories:
  - Mechanical
  - Mechanical with application of herbicide
  - Herbicide

**Special Maintenance Considerations**

Riparian buffer restoration sites should be monitored to maximize wildlife habitat and water quality benefits, and to discover emerging threats to the project. During the first four years, the new buffer should be monitored four times annually (February, May, August, and November are recommended) and inspected after any severe storm. Repairs should be made as soon as possible.

Depending on restoration site size, the buffer area should be sampled to approximate survival rate. Data derived should consider survival of the planted material and natural regeneration to determine if in-fill planting should occur to supplement plant density.

Survival rates of at least 70% are deemed to be successful. Calculate percent survival by the following equation:

$$(\# \text{ of live plants} / \# \text{ of installed plants}) 100 = \% \text{ survival}$$



## Cost Issues

Establishment and maintenance costs should be considered up front in the riparian buffer plan design. Installing a forest riparian buffer involves site preparation, tree planting, second year reinforcement planting, and additional maintenance. Both the USDA Riparian Handbook and the PADEP/PADCNR Stream ReLeaf Forest Buffer Toolkit utilize a basic outline for estimating costs for establishment and maintenance:

Costs may fluctuate based on numerous variables including whether or not volunteer labor is utilized, whether plantings and other supplies are donated or provided at a reduced cost.

## Specifications

**The USDA Forest Service developed a riparian forest buffer specification, which outlines three distinct zones and establishes the minimally acceptable requirements for reforestation by landowners.**

### Definition

An area of trees and other vegetation located in areas adjoining and upgradient from surface water bodies and designed to intercept surface runoff, wastewater, subsurface flow, and deeper groundwater flows from upland sources for the purpose of removing or buffering the effects of associated nutrients, sediment, organic matter, pesticides, or other pollutants prior to entry into surface waters and ground water recharge areas.

### Scope

This specification establishes the minimally acceptable requirements for the reforestation of open lands, and renovation of existing forest to be managed as Riparian Forest Buffers for the purposes stated.

### Purpose

To remove nutrients, sediment, animal-derived organic matter, and some pesticides from surface runoff, subsurface flow, and near root zone groundwater by deposition, absorption, adsorption, plant uptake, denitrification, and other processes, thereby reducing pollution and protecting surface water and groundwater quality.

### Conditions Where Practice Applies

Subsurface nutrient buffering processes, such as denitrification, can take place in the soil wherever carbon energy, bacteria, oxygen, temperature, and soil moisture is adequate. Nutrient uptake by plants occurs where the water table is within the root zone. Surficial filtration occurs anywhere surface vegetation and forest litter are adequate.

The riparian forest buffer will be most effective when used as a component of a sound land management system including nutrient management and runoff, and sediment and erosion control practices. Use of this practice without other nutrient and runoff, sediment and erosion control practices can result in adverse impacts on buffer vegetation and hydraulics including high maintenance costs, the need for periodic replanting, and the carrying of excess nutrients and sediment through the buffer by concentrated flows.

This practice applies on lands:

1. adjacent to permanent or intermittent streams which occur at the lower edge of upslope cropland, grassland or pasture;

2. at the margins of lakes or ponds which occur at the lower edge of upslope cropland, grassland or pasture;
3. at the margin of any intermittent or permanently flooded, environmentally sensitive, open water wetlands which occur at the lower edge of upslope cropland, grassland or pasture;
4. on karst formations at the margin of sinkholes and other small groundwater recharge areas occurring on cropland, grassland, or pasture.

Note: In high sediment production areas (8-20 in./100 yrs.), severe sheet, rill, and gully erosion must be brought under control on upslope areas for this practice to function correctly.

**Riparian Buffer Installation Costs - Estimation per Acre**

	Cost, ea.	Number	Cost, Total
<b>Phase 1: Establishment</b>			
<i>Preparation</i>			
Light site preparation (mow, disking)	-	-	\$ 12.00
<i>Planting</i>			
Tree Seedlings (12" - 18" Hardwoods)	\$ 1.15	430	\$ 494.50
Tree Shelters (optional)	\$ 5.00	430	\$ 2,150.00
Fencing (1 ac = 282 ft) (optional)			\$ 564.00
<b>Subtotal</b>			<b>\$ 3,220.50</b>
<b>Phase 2: Maintenance</b>			
<i>Reinforcement Planting</i>			
Tree Seedlings in Year 2	\$ 1.15	50	\$ 57.50
Herbicide Treatment (optional)			\$ 54.00
Mowing (optional)			\$ 12.00
<b>Subtotal</b>			<b>\$ 123.50</b>
<b>Total Costs, no options</b>			<b>\$ 564.00</b>
<b>Total Costs, with options</b>			<b>\$ 3,344.00</b>

## Design Criteria

### Riparian Forest Buffers

Riparian forest buffers will consist of three distinct zones and be designed to filter surface runoff as sheet flow and downslope subsurface flow, which occurs as shallow groundwater. For the purposes of these buffer strips, shallow groundwater is defined as: saturated conditions which occur near or within the root zone of trees, and other woody vegetation and at relatively shallow depths where bacteria, oxygen, and soil temperature contribute to denitrification. Streamside Forest Buffers will be designed to encourage sheet flow and infiltration and impede concentrated flow.

#### Zone 1

##### Location

Zone 1 will begin at the top of the streambank and occupy a strip of land with a fixed width of fifteen feet measured horizontally on a line perpendicular to the streambank.

##### Purpose

The purpose of Zone 1 is to create a stable ecosystem adjacent to the water's edge, provide soil/water contact area to facilitate nutrient buffering processes, provide shade to moderate and stabilize water temperature encouraging the production of beneficial algal forms, and to contribute necessary detritus and large woody debris to the stream ecosystem.

##### Requirements

Runoff and wastewater to be buffered or filtered by Zone 1 will be limited to sheet flow or subsurface flow only. Concentrated flows must be converted to sheet flow or subsurface flows prior to entering Zone 1. Outflow from subsurface drains must not be allowed to pass through the riparian forest in pipes or tile, thus circumventing the treatment processes. Subsurface drain outflow must be converted to sheet flow for treatment by the riparian forest buffer, or treated elsewhere in the system prior to entering the surface water.

Dominant vegetation will be composed of a variety of native riparian tree and shrub species and such plantings as necessary for streambank stabilization during the establishment period. A mix of species will provide the prolonged stable leaf fall and variety of leaves necessary to meet the energy and pupation needs of aquatic insects.

Large overmature trees are valued for their detritus and large woody debris. Zone 1 will be limited to bank stabilization and removal of potential problem vegetation. Occasional removal of extreme high value trees may be permitted where water quality values are not compromised. Logging and other overland equipment shall be excluded except for stream crossings and stabilization work.

Livestock will be excluded from Zone 1 except for designed stream crossings.

## Zone 2

### Location

Zone 2 will begin at the edge of Zone 1 and occupy an additional strip of land with a minimum width of 60 feet measured horizontally on a line perpendicular to the streambank. Total minimum width of Zones 1 & 2 is therefore 75 feet. Note that this is the minimum width of Zone 2 and that the width of Zone 2 may have to be increased as described in the section “Determining the Total Width of Buffer” to create a greater combined width for Zones 1 & 2.

### Purpose

The purpose of Zone 2 is to provide necessary contact time and carbon energy source for buffering processes to take place, and to provide for long term sequestering of nutrients in the form of forest trees. Outflow from subsurface drains must not be allowed to pass through the riparian forest in pipe or tile, thus circumventing the treatment processes. Subsurface drain outflow must be converted to sheet flow for treatment by the riparian forest buffer, or treated elsewhere in the system prior to entering the surface water.

### Requirements

Runoff and wastewater to be buffered or filtered by Zone 2 will be limited to sheet flow or subsurface flow only. Concentrated flows must be converted to sheet flow or subsurface flows prior to entering Zone 2.

Predominant vegetation will be composed of riparian trees and shrubs suitable to the site, with emphasis on native species, and such plantings as necessary to stabilize soil during the establishment period. Nitrogen-fixing species should be discouraged where nitrogen removal or buffering is desired. Species suitability information should be developed in consultation with state and federal forestry agencies, Natural Resources Conservation Service, and USDI Fish and Wildlife Service.

Specifications should include periodic harvesting and timber stand improvement (TSI) to maintain vigorous growth and leaf litter replacement, and to remove nutrients and pollutants sequestered in the form of wood in tree boles and large branches. Management for wildlife habitat, aesthetics, and timber are not incompatible with riparian forest buffer objectives as long as shade levels and production of leaf litter, detritus, and large woody debris are maintained. Appropriate logging equipment recommendations shall be determined in consultation with the state and federal forestry agencies.

Livestock shall be excluded from Zone 2 except for necessary designed stream crossings.

## Zone 3

### Location

Zone 3 will begin at the outer edge of Zone 2 and have a minimum width of 20 feet. Additional width may be desirable to accommodate land-shaping and mowing machinery. Grazed or ungrazed grassland meeting the purpose and requirements stated below may serve as Zone 3.

### Purpose

The purpose of Zone 3 is to provide sediment filtering, nutrient uptake, and the space necessary to convert concentrated flow to uniform, shallow, sheet flow through the use of techniques such as grading and shaping, and devices such as diversions, basins, and level lip spreaders.

### Requirements

Vegetation will be composed of dense grasses and forbs for structure stabilization, sediment control, and nutrient uptake. Mowing and removal of clippings are necessary to recycle sequestered nutrients, promote vigorous sod, and control weed growth.

Vegetation must be maintained in a vigorous condition. The vegetative growth must be hayed, grazed, or otherwise removed from Zone 3. Maintaining vigorous growth of Zone 3 vegetation must take precedence and may not be consistent with wildlife needs.

Zone 3 may be used for controlled intensive grazing when conditions are such that earthen water control structures will not be damaged.

Zone 3 may require periodic reshaping of earth structures, removal or grading of accumulated sediment, and reestablishment of vegetation to maintain effectiveness of the riparian buffer.

### **Determining Need For Protection**

Buffers should be used to protect any body of water which will not be:

- treated by routing through a natural or artificial wetland determined to be adequate treatment;
- treated by converting the flow to sheet flow and routing it through a forest buffer at a point lower in the watershed.

### **Determining Total Width of the Buffer**

Note that while not specifically addressed, slope and soil permeability are components of the following buffer width criteria.

Each of the following criteria is based on methods developed, or used by persons conducting research on riparian forests.

### **Streamside Buffers**

The minimum width of streamside buffer areas can be determined by any number of methods suitable to the geographic area.

1. Based on soil hydrologic groups as shown in the county soil survey report, the width of Zone 2 will be increased to occupy any soils designated as Hydrologic Group D and those soils of Hydrologic Group C which are subject to frequent flooding. If soils of Hydrologic Groups A or B occur adjacent to intermittent or perennial streams, the combined width of Zones 1 & 2 may be limited to the 75 foot minimum.
2. Based on area, the width of Zone 2 should be increased to provide a combined width of Zones 1 & 2 equal to one third of the slope distance from the streambank to the top of the pollutant source area. The effect is to create a buffer strip between field and stream which occupies approximately one third of the source area.

3. Based on the Land Capability Class of the buffer site as shown in the county soil survey, the width of Zone 2 should be increased to provide a combined width of Zones 1 & 2 as shown below.

Capability Class	Buffer Width
Cap. I, II e/s, V	75'
Cap. III e/s, IV e/s	100'
Cap. VI e/s, VII e/s	150'

**Pond and Lake-Side Buffer Strips**

The area of pond or lake-side buffer strips should be at least one-fifth the drainage area of the cropland and pastureland source area. The width of the buffer strip is determined by creating a uniform width buffer of the required area between field and pond. Hydrologic Group and Capability Class methods of determining width remain the same as for streamside buffers. Minimum widths apply in all cases.

**Environmentally Sensitive Wetlands**

Some wetlands function as nutrient sinks. When they occur in fields or at field margins, they can be used for renovation of agricultural surface runoff and/or drainage. However, most wetlands adjoining open water are subject to periodic flushing of nutrient-laden sediments and, therefore, require riparian buffers to protect water quality.

Where open water wetlands are roughly ellipsoid in shape, they should receive the same protection as ponds.

Where open water wetlands exist in fields as seeps along hillslopes, buffers should consist of Zones 1, 2 & 3 on sides receiving runoff and Zones 1 & 3 on the remaining sides. Livestock must be excluded from Zones 1 & 2 at all times and controlled in Zone 3. Where Zones 1 & 3 only are used, livestock must be excluded from both zones at all times, but hay removal is desirable in Zone 3.

**Vegetation Selection**

Zone 1 & 2 vegetation will consist of native streamside tree species on soils of Hydrologic Groups D and C and native upland tree species on soils of Hydrologic Groups A and B.

Deciduous species are important in Zone 2 due to the production of carbon leachate from leaf litter which drives bacterial processes that remove nitrogen, as well as, the sequestering of nutrients in the growth processes. In warmer climates, evergreens are also important due to the potential for nutrient uptake during the winter months. In both cases, a variety of species is important to meet the habitat needs of insects important to the aquatic food chain.

Zone 3 vegetation should consist of perennial grasses and forbs.

Species recommendations for vegetated buffer areas depend on the geographic location of the buffer. Suggested species lists should be developed in collaboration with appropriate state and federal forestry agencies, the Natural Resources Conservation Service, and the USDI Fish and Wildlife Service. Species lists should include trees, shrubs, grasses, legumes, forbs, as well as site preparation techniques. Fertilizer and lime, helpful in establishing buffer vegetation, must be used with caution and are not recommended in Zone 1.

## Maintenance Guidelines

### General

Buffers must be inspected annually and immediately following severe storms for evidence of sediment deposit, and erosion, or concentrated flow channels. Prompt corrective action must be taken to stop erosion and restore sheet flow.

The following should be avoided within the buffer areas: excess use of fertilizers, pesticides, or other chemicals; vehicular traffic or excessive pedestrian traffic; and removal or disturbance of vegetation and litter inconsistent with erosion control and buffering objectives.

Zone 1 vegetation should remain undisturbed except for removal of individual trees of extremely high value or trees presenting unusual hazards such as potentially blocking culverts.

Zone 2 vegetation, undergrowth, forest floor, duff layer, and leaf litter shall remain undisturbed except for periodic cutting of trees to remove sequestered nutrients; to maintain an efficient filter by fostering vigorous growth; and for spot site preparation for regeneration purposes. Controlled burning for site preparation, consistent with good forest management practices, could also be used in Zone 2.

Zone 3 vegetation should be mowed and the clippings removed as necessary to remove sequestered nutrients and promote dense growth for optimum soil stabilization. Hay or pasture uses can be made compatible with the objectives of Zone 3.

Zone 3 vegetation should be inspected twice annually, and remedial measures taken as necessary to maintain vegetation density and remove problem sediment accumulations.

### Stable Debris

As Zone 1 reaches 60 years of age, it will begin to produce large stable debris. Large debris, such as logs, create small dams which trap and hold detritus for processing by aquatic insects, thus adding energy to the stream ecosystem, strengthening the food chain, and improving aquatic habitat. Wherever possible, stable debris should be conserved.

Where debris dams must be removed, try to retain useful, stable portions which provide detritus storage.

Deposit removed material a sufficient distance from the stream so that it will not be refloated by high water.

## Planning Considerations

1. Evaluate the type and quantity of potential pollutants that will be derived from the drainage area.
2. Select species adapted to the zones based on soil, site factors, and possible commercial goals such as timber and forage.

3. Plan to establish trees early in the dormant season for maximum viability.
4. Be aware of visual aspects and plan for wildlife habitat improvement if desired.
5. Consider provisions for mowing and removing vegetation from Zone 3. Controlled grazing may be satisfactory in Zone 3 when the filter area is dry and firm.

## References

Natural Resources Conservation Service. 1997. USDA Natural Resources Conservation Practice Standard Riparian Forest Buffer. USDA Natural Resources Conservation Service.

Palone, R.S. and A.H. Todd (editors.) 1997. Chesapeake Bay Riparian Handbook: A Guide for Establishing and Maintaining Riparian Forest Buffers. USDA Forest Service. NA-TP-02-97. Radnor, PA. <http://www.chesapeakebay.net/pubs/subcommittee/nsc/forest> or order from: U.S. EPA Chesapeake Bay Program. 410 Severn Ave. Suite 109. Annapolis, MD. 1-800-968-7229.

PA Department of Environmental Protection. 1998. *Pennsylvania Stream ReLeaf – Forest Buffer Toolkit*, <http://www.dep.state.pa.us/dep/deputate/watermgt/WC/Subjects/StreamReLeaf/default.htm>

Tjaden, R.L. and G.M. Weber. 1997. An Introduction to the Riparian Forest Buffer. Maryland Cooperative Extension Fact Sheet 724. College Park, MD. 2 pages. <http://www.riparianbuffers.umd.edu/PDFs/FS724.pdf>.

Tjaden, R.L. and G.M. Weber. 1997. Riparian Buffer Systems. Maryland Cooperative Extension Fact Sheet 733. College Park, MD. 2 pages. <http://www.riparianbuffers.umd.edu/PDFs/FS733.pdf>.



## BMP 6.7.2: Landscape Restoration



Landscape Restoration is the general term used for actively sustainable landscaping practices that are implemented outside of riparian (or other specially protected) buffer areas. Landscape Restoration includes the restoration of forest (i.e. reforestation) and/or meadow and the conversion of turf to meadow. In a truly sustainable site design process, this BMP should be considered only after the areas of development that require landscaping and/or revegetation are minimized. The remaining areas that do require landscaping and/or revegetation should be driven by the selection and use of vegetation (i.e., native species) that does not require significant chemical maintenance by fertilizers, herbicides, and pesticides..

<p style="text-align: center;"><b><u>Key Design Elements</u></b></p> <ul style="list-style-type: none"> <li>▪ Minimize traditional turf lawn area</li> <li>▪ Maximize landscape restoration area planted with native vegetation</li> <li>▪ Protect landscape restoration area during construction</li> <li>▪ Prevent post-construction erosion through adequate stabilization</li> <li>▪ Minimize fertilizer and chemical-based pest control programs</li> <li>▪ Creates and maintains porous surface and healthy soil.</li> <li>▪ Minimize mowing (two times per year)</li> <li>▪ Reduced maintenance cost compared to lawn</li> </ul>	<p style="text-align: center;"><b><u>Potential Applications</u></b></p> <p>Residential: Yes                  Commercial: Yes                  Ultra Urban: Limited                  Industrial: Yes                  Retrofit: Yes                  Highway/Road: Yes</p>
	<p style="text-align: center;"><b><u>Stormwater Functions</u></b></p> <p>Volume Reduction: Low/Med.                  Recharge: Low/Med.                  Peak Rate Control: Low/Med.                  Water Quality: Very High</p>
	<p style="text-align: center;"><b><u>Water Quality Functions</u></b></p> <p>TSS: 85%                  TP: 85%                  NO3: 50%</p>

**Other Considerations**

- Soil investigation recommended
- Soil restoration may be necessary

## Description

In an integrated stormwater management plan, the landscape is a vital factor, not only in sustaining the aesthetic and functional resources of a site, but also in mitigating the volume and rate of stormwater runoff. Sustainable landscaping, or Landscape Restoration, is an effective method of improving the quality of site runoff. This often overlooked BMP includes the restoration of forest and/or meadow or the conversion of turf to meadow.

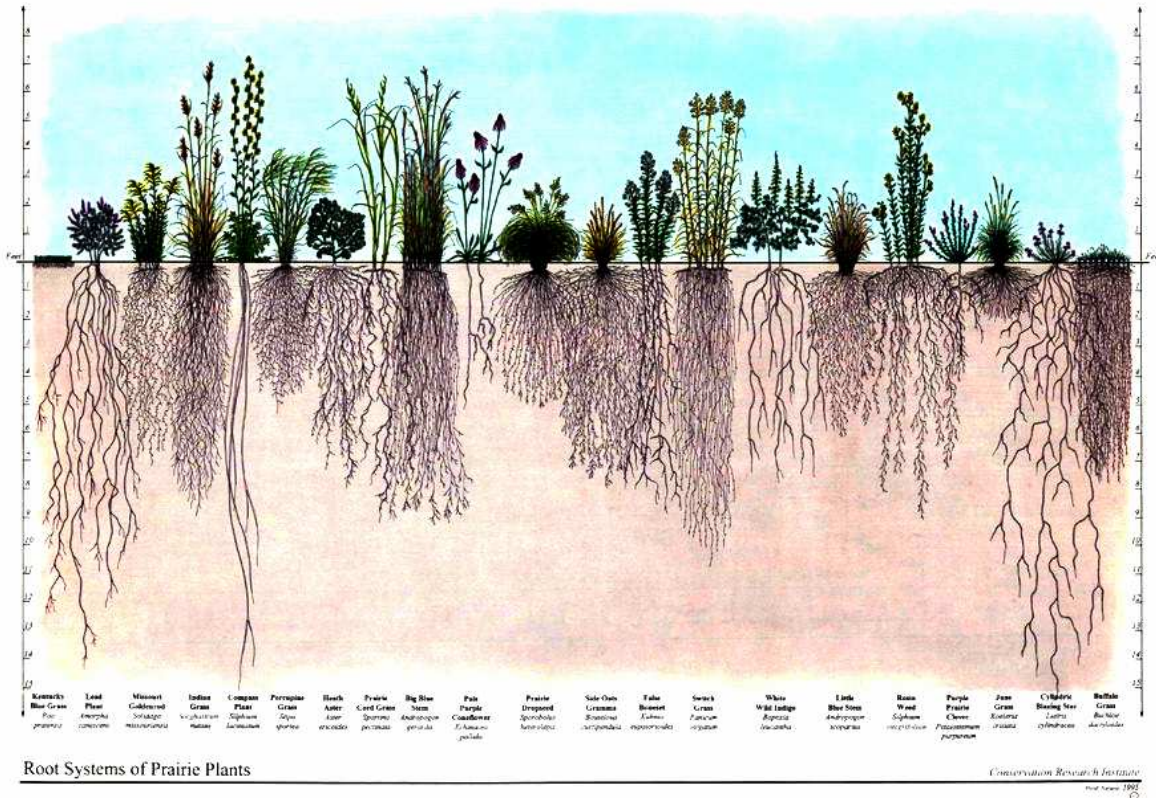


Landscape Restoration involves the careful selection and use of vegetation that does not require significant chemical maintenance by fertilizers, herbicides and pesticides. Implicit in this BMP is the assumption that native species have the greatest tolerance and resistance to pests and require less fertilization and chemical application than do nonnative species. Furthermore, since native grasses and other herbaceous materials often require less intensive maintenance efforts (i.e. mowing or trimming), their implementation on a site results in less biomass produced.

Native species are customarily strong growers with stronger and denser root and stem systems, thereby generating less runoff. If the objective is revegetation with woodland species, the longer-term effect is a significant reduction in runoff volumes, with increases in infiltration, evapotranspiration, and recharge, when contrasted with a conventional lawn planting. Peak rate reduction also is achieved. Similarly, meadow reestablishment is also more beneficial than a conventional lawn planting, although not so much as the woodland landscape. Again, these benefits are long term in nature and will not be forthcoming until the species have had an opportunity to grow and mature (one advantage of the meadow is that this maturation process requires considerably less time than a woodland area). Native grasses also tend to have substantially deeper roots and more root mass than turf grasses, which results in:

- A greater volume of water uptake (evapotranspiration)
- Improved soil conditions through organic material and macropore formation
- Provide for greater infiltration

Landscape architects specializing in the local plant community are usually able to identify a variety of species that meet these criteria. Other sources of advice may be county conservation districts, watershed associations and other conservation groups. As the selection of such materials begins at the conceptual design stage, where lawns are eliminated or avoided altogether and landscaping species selected, Landscape Restoration can generally result in a site with reduced runoff volume and rate, as well as significant nonpoint source load reduction/prevention.



Landscape Restoration can improve water quality by minimizing application of fertilizers and pesticides/herbicides. Given the high rates of chemical application which have been documented at newly created lawns for both residential and nonresidential land uses, eliminating the need for chemical application is important for water quality. Of special importance here is the reduction in fertilization and nitrate loadings. For example, Delaware's *Conservation Design for Stormwater Management* lists multiple studies that document high fertilizer application rates, including both nitrogen and phosphorus, in newly created landscapes in residential and nonresidential land developments. Expansive lawn areas in low density single-family residential subdivisions as well as large office parks typically receives intensive chemical application, both fertilization and pest control, which can exceed application rates being applied to agricultural fields. Avoidance of this nonpoint pollutant source is an important water quality objective.

**Variations**

- Meadow
- No-mow lawn area
- Woodland restoration
- Removal of existing lawn to reduce runoff volume
- Buffers between lawn areas and wetlands or stream corridors
- Replacement of “wet” lawn areas difficult to mow
- Replacement of hard to maintain lawns under mature trees

## Applications

- Forested Landscape/Restoration
- Suburban / Developing Landscape
- Urban Landscape
- Meadow Restoration
- Conversion of Turf to Meadow

## Design Considerations

1. The recommended guidelines for Landscape Restoration are very closely related to those of Riparian Buffer Restoration (RBR) (BMP 6.7.1). Specifically, Landscape Restoration overlaps with the guidelines for Zones 2 and 3 in typical RBR. As with RBR, it is essential for successful Landscape Restoration that site conditions be well understood, objectives of the landowner considered, and the appropriate plants chosen for the site. These are all tasks that should be completed in the early planning stages of a project. For a summary of the nine steps recommended for the planning stages of a restoration project, see BMP 6.7.1- Riparian Buffer Restoration. Included in this nine-step process are: analysis of site soils/natural vegetative features/habitat significance/topography/etc., determination of restoration suitability, and site preparation.
2. In those sites where soils have been disturbed or determined inadequate for restoration (based on analysis), soil amendments are needed. Soil amendment and restoration is the process of restoring compromised soils by subsoiling and/or adding a soil amendment, such as compost, for the purpose of reestablishing its long-term capacity for infiltration and pollution removal. For more information on restoring soils, see BMP 6.7.3 Soil Amendments and Restoration.
3. “Native species” is a broad term. Different types of native species landscapes may be created, from meadow to woodland areas, obviously requiring different approaches to planting. A native landscape may take several forms in Pennsylvania, ranging from reestablishment of woodlands with understory plantings to reestablishment of meadow. It should be noted that as native landscapes grow and mature, the positive stormwater benefits relating to volume control and peak rate control increase. So, unlike highly maintained turf lawns, these landscapes become much more effective in reducing runoff volumes and nonpoint source pollutants over time.
4. Minimizing the extent of lawn is one of the easiest and most effective ways of improving water quality. Typical (i.e. compacted) lawns on gentle slopes can produce almost as much runoff as pavement. In contrast to turf, “natural forest soils with similar overall slopes can store up to 50 times more precipitation than neatly graded turf.” (Arendt, Growing Greener, pg. 81)  
The first step in sustainable site design is to limit the development footprint as much as possible, preserving natural site features, such as vegetation and topography. If lawn areas are desired in certain areas of a site, they should be confined to those areas with slopes less than 6%.



5. Meadow restoration may be used alone or in combination with a forest restoration. The native meadow landscape provides a land management alternative that benefits stormwater management by reducing runoff volume and nonpoint source pollutant transport. Furthermore, meadow landscapes vastly reduce the need for maintenance, as they do not require frequent mowing during the growing season. Because native grasses and flowers are almost exclusively perennials, properly installed meadows are a self-sustaining plant community that will return year after year.

Meadows can be constructed as a substitute to turf on the landscape, or they can be created as a buffer between turf and forest. In either situation, the meadow restoration acts to reduce runoff as well as reduce erosion and sedimentation. Meadow buffers along forests also help reduce off-trail pedestrian traffic in order to avoid creating paths which can further concentrate stormwater.

The challenge in restoring meadow landscapes is a lack of effective establishment and maintenance methods. Native grasses and flowers establish more slowly than weeds and turf grass. Therefore, care must be taken when creating meadow on sites where weed or other vegetative communities are well established. It may take a year or more to prepare the site and to get weeds under control before planting. Erosion prone sites should be planted with a nurse crop (such as annual rye) for quick vegetation establishment to prevent seed and soil loss. Steep slopes and intermittent water courses should be stabilized with erosion blankets, selected to mitigate expected runoff volumes and velocities. Additionally, seed quality is extremely important to successful establishment. There is tremendous variation among seed suppliers, seeds should be chosen with a minimum percent of non-seed plant parts.

6. Conversion of turf grass areas to meadow is relatively simple and has enormous benefits for stormwater management. Though turf is inexpensive to install, the cost of maintenance to promote an attractive healthy lawn is high (requiring mowing, irrigation, fertilizer, lime and



herbicides) and its effects are detrimental to water quality. Turf areas are good candidates for conversion to meadow as they typically have lower density of weed species. The conversion of turf to meadow requires that all turf be eliminated before planting, and care must be taken to control weed establishment prior to planting.

7. Forest restoration includes planting of appropriate tree species (small saplings) with quick establishment of an appropriate ground cover around the trees in order to stabilize the soil and prevent colonization of invasive species. Reforestation can be combined with other volume control BMPs such as retentive berming, vegetated filter strips and swales.

Plant selection should mimic the surrounding native vegetation and expand on the native species composition already found on the site. A mixture of native trees and shrubs is recommended and should be planted once a ground cover is established.

8. In terms of woodland areas, DCNR’s *Conservation Design for Stormwater Management* states, “...a mixture of young trees and shrubs is recommended.... Tree seedlings from 12 to 18 inches in height can be used, with shrubs at 18 to 24 inches. Once a ground cover crop is established (to offset the need for mowing), trees and shrubs should be planted on 8-foot centers, with a total of approximately 430 trees per acre. Trees should be planted with tree shelters to avoid browse damage in areas with high deer populations, and to encourage more rapid growth.” (p.3-50).



Initial watering and weekly watering during dry periods may be necessary during the first growing season. As tree species grow larger, both shrubs and ground covers recede and yield to the more dominant tree species. The native tree species mix of small inexpensive saplings should be picked for variety and should reflect the local forest communities. Annual mowing to control invasives may be necessary, although the quick establishment of a strong-growing ground cover can be effective in providing invasive control. Native meadow planting mixes also are available. A variety of site design factors may influence the type of vegetative community that is to be planned and implemented. In so many cases, the “natural” vegetation of Pennsylvania’s communities is, of course, woodland.

9. Ensure adequate stabilization. Adequate stabilization is extremely important as native grasses, meadow flowers, and woodlands establish more slowly than turf. Stabilization can be achieved for forest restoration by establishing a ground cover before planting of trees and shrubs. When creating meadows, it may be necessary to plant a fast growing nurse crop with meadow seeds for quick stabilization. Annual rye can be planted in the fall or spring with meadow seeds and will establish quickly and usually will not present a competitive problem. Erosion prone sites should be planted with a nurse crop and covered with weed-free straw mulch, while steep slopes and areas subject to runoff should be stabilized with erosion control blankets suitable for the expected volume and velocity of runoff.

### **Volume Reduction Calculations and Peak Rate Mitigation**

Areas designated for landscape restoration should be considered as “Meadow, good condition” in stormwater calculations.

### **Water Quality Improvement**

See Section 8 for Water Quality Improvement methodology, which addresses pollutant removal effectiveness of this BMP.

### **Construction Sequence**

Forest restoration installation follows closely the procedure outlined in BMP 6.7.1- Riparian Buffer Restoration. Refer to BMP 6.7.1 for detailed information, with the understanding that species selection for upland forest restoration will differ from that for riparian restoration.

Meadow installation should proceed as follows:

#### **1. SELECT SITE**

- Confirm site is suitable for restoration, should be sunny, open and well-ventilated. Meadow plants require at least a half a day of full sun.
- Obtain landowner permission

#### **2. ANALYZE SITE**

- Evaluate site's physical conditions (soil attributes, geology, terrain)
- Evaluate site's vegetative features (desirable and undesirable species, native species, sensitive habitats). Good candidates for meadow plantings include areas presently in turf, cornfields, soybean fields, alfalfa fields and bare soils from new construction.
- Areas with a history of heavy weed growth may require a full year or longer to prepare for planting.
- Beware of residual herbicides that may have been applied to agricultural fields. Always check the herbicide history of the past 2-3 years and test the soils if in doubt.

#### **3. PLANT SELECTION**

- Select plants that are well adapted to the specific site conditions. Meadow plants must be able to out compete weed species in the first few years as they become established.

#### **4. PREPARE SITE**

- All weeds or existing vegetation must be eliminated prior to seeding.
- Perennial weeds may require year long smothering, repeated sprayings with herbicides, or repeated tillage with equipment that can uproot and kill perennial weeds.

#### **5. PLANTING DAY**

- Planting can take place from Spring thaw through June 30 or from September 1 through soil freeze-up (“dormant seeding”)
- Planting in July and August is generally not recommended due to the frequency of drought during this time.
- Seeding can be accomplished by a variety of methods: no-till seeder for multi-acre planting; broadcast seeder; hand broadcast for small areas of one acre or less.
- Seed quality is critical and a seed mix should be used with a minimum percentage of non-seed plant parts.

**6. SITE MAINTENANCE (additional information below)**

- Assign responsibilities for watering, weeding, mowing, and maintenance
- Monitor site regularly for growth and potential problems

**Maintenance Issues**

Meadows and Forests are low maintenance but not “no maintenance”. They usually require more frequent maintenance in the first few years immediately following installation.

Forest restoration areas planted with a proper cover crop can be expected to require annual mowing in order to control invasives. Application of a carefully selected herbicide (Roundup or similar glyphosate herbicide) around the protective tree shelters/tubes may be necessary, reinforced by selective cutting/manual removal, if necessary. This initial maintenance routine is necessary for the initial 2 to 3 years of growth and may be necessary for up to 5 years until tree growth and tree canopy begins to form, naturally inhibiting weed growth (once shading is adequate, growth of invasives and other weeds will be naturally prevented, and the woodland becomes self-maintaining). Review of the new woodland should be undertaken intermittently to determine if replacement trees should be provided (some modest rate of planting failure is usual).

Meadow management is somewhat more straightforward; a seasonal mowing or burning may be required, although care must be taken to make sure that any management is coordinated with essential reseeding and other important aspects of meadow reestablishment. In the first year weeds must be carefully controlled and consistently mowed back to 4-6 inches tall when they reach 12 inches in height. In the second year, weeds should continue to be monitored and mowed and rhizomatous weeds should be hand treated with herbicide. Weeds should not be sprayed with herbicide as the drift from the spray may kill large patches of desirable plants, allowing weeds to move in to these new open areas. In the beginning of the third season, the young meadow should be burned off in mid-spring. If burning is not possible, the meadow should be mowed very closely to the ground instead. The mowed material should be removed from the site to expose the soil to the sun. This helps encourage rapid soil warming which favors the establishment of “warm season” plants over “cool season” weeds.

**Cost Issues**

Landscape restoration cost implications are minimal during construction. Seeding for installation of a conventional lawn is likely to be less expensive than planting of a “cover” of native species, although when contrasted with a non-lawn landscape, “natives” often are not more costly than other nonnative landscape species. In terms of woodland creation, somewhat dated (1997) costs have been provided by the *Chesapeake Bay Riparian Handbook: A Guide for Establishing and Maintaining Riparian Forest Buffers*:

- \$860/acre trees with installation
- \$1,600/acre tree shelters/tubes and stakes
- \$300/acre for four waterings on average

In current dollars, these values would be considerably higher, well over \$3,000/acre for installation costs. Costs for meadow reestablishment are lower than those for woodland, in part due to the



elimination of the need for shelters/tubes. Again, such costs can be expected to be greater than installation of conventional lawn (seeding and mulching), although the installation cost differences diminish when conventional lawn seeding is redefined in terms of conventional planting beds.

Cost differentials grow greater when longer term operating and maintenance costs are taken into consideration. If lawn mowing can be eliminated, or even reduced significantly to a once per year requirement, substantial maintenance cost savings result, often in excess of \$1,500 per acre per year. If chemical application (fertilization, pesticides, etc.) can be eliminated, substantial additional savings result with use of native species. These reductions in annual maintenance costs resulting from a native landscape reestablishment very quickly outweigh any increased installation costs that are required at project initiation. Unfortunately, because developers pay for the installation costs and longer term reduced maintenance costs are enjoyed by future owners, there is reluctance to embrace native landscaping concepts.

### **Specifications**

The following specifications are provided for information purposes only. These specifications include information on acceptable materials for typical applications, but are by no means exclusive or limiting. The designer is responsible for developing detailed specifications for individual design projects in accordance with the project conditions.

Vegetation – See Appendix B

## References

- Bowman's Hill Wildflower Preserve, Washington Crossing Historic Park, PO Box 685, New Hope, PA 18938-0685, Tel (215) 862-2924, Fax (215) 862-1846, Native plant reserve, plant sales, native seed, educational programs, [www.bhwp.org](http://www.bhwp.org)
- Morris Arboretum of the University of Pennsylvania; 9414 Meadowbrook Avenue, Philadelphia, PA 19118, Tel (215) 247-5777, [www.upenn.edu/morris](http://www.upenn.edu/morris), PA Flora Project Website: Arboretum and gardens (some natives), educational programs, PA Flora Project, [www.upenn.edu/paflora](http://www.upenn.edu/paflora)
- Pennsylvania Department of Conservation and Natural Resources; Bureau of Forestry; PO Box 8552, Harrisburg, PA 17105-8552, Tel (717)787-3444, Fax (717)783-5109, Invasive plant brochure; list of native plant and seed suppliers in PA; list of rare, endangered, threatened species.
- Pennsylvania Native Plant Society, 1001 East College Avenue, State College, PA 16801  
[www.pawildflower.org](http://www.pawildflower.org)
- Western Pennsylvania Conservancy; 209 Fourth Avenue, Pittsburgh, PA 15222, Tel (412) 288-2777, Fax (412) 281-1792, [www.paconserve.org](http://www.paconserve.org)
- Conservation Design for Stormwater Management (DNREC and EMC)
- Stream ReLeaf Plan and Toolkits
- The Once and Future Forest – Leslie Sauer
- Forestry Best Management Practices for Water Quality – Virginia Department of Forestry
- Chesapeake Bay Riparian Handbook: A Guide for Establishing and Maintaining Riparian Forest Buffers (1997)
- Arendt, R. *Growing Greener*. Island Press, November 1999.
- Diboll, Neil. Five Steps to Successful Prairie Meadow Establishment. Windstar Wildlife Institute.
- Penn State College of Agricultural Sciences, Agricultural Research and Cooperation Extension. “ Pennsylvania Wildlife No. 12: Warm-season Grasses and Wildlife” and “Pennsylvania Wildlife No. 5: Meadows and Prairies: Wildlife-friendly Alternatives to Lawn”

## BMP 6.7.3: Soil Amendment & Restoration



Soil amendment and restoration is the process of improving disturbed soils and low organic soils by restoring soil porosity and/or adding a soil amendment, such as compost, for the purpose of reestablishing the soil's long-term capacity for infiltration and pollution removal.

<p style="text-align: center;"><b><u>Key Design Elements</u></b></p> <ul style="list-style-type: none"> <li>▪ Existing soil conditions should be evaluated before forming a restoration strategy.</li> <li>▪ Physical loosening of the soil, often called subsoiling, or tilling, can treat compaction.</li> <li>▪ The combination of subsoiling and soil amendment is often the more effective strategy.</li> <li>▪ Compost amendments increase water retention.</li> </ul>	<p style="text-align: center;"><b><u>Potential Applications</u></b></p> <p>Residential: Yes                  Commercial: Yes                  Ultra Urban: Yes                  Industrial: Yes                  Retrofit: Yes                  Highway/Road: Yes</p>
	<p style="text-align: center;"><b><u>Stormwater Functions</u></b></p> <p>Volume Reduction: Low/Med.                  Recharge: Low/Med.                  Peak Rate Control: Medium                  Water Quality: Medium</p>
	<p style="text-align: center;"><b><u>Water Quality Functions</u></b></p> <p>TSS: 85%                  TP: 85%                  NO3: 50%</p>

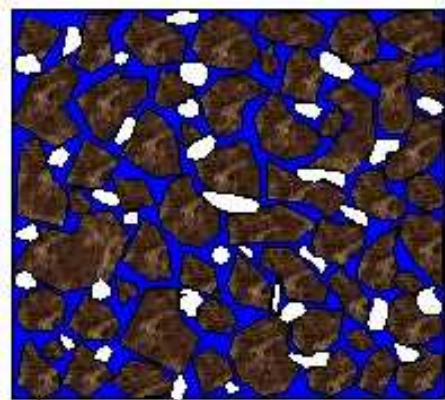
### Problem Description

Animals, farm equipment, trucks, construction equipment, cars, and people cause compaction. Wet soil compacts easier than dry soil. Natural compaction occurs due to special chemical or physical properties, and these occurrences are called “hard pans”. A typical soil after compaction has strength of about 6,000 kPa, while studies have shown that root growth is not possible beyond 3,000 kPa.

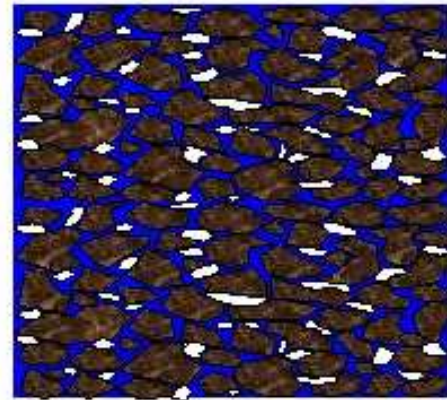
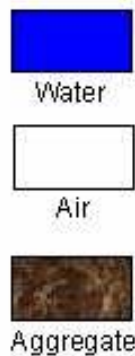


### Different Types of Compaction

- 1) Minor Compaction – surface compaction within 8-12” due to contact pressure, axle load > 10 tons can compact through root zone, up to 1’ deep
- 2) Major Compaction – deep compaction, contact pressure and total load, axle load > 20 tons can compact up to 2’ deep (usually large areas compacted to increase strength for paving and foundation with overlap to “lawn” areas)



**good physical condition**



**poor physical condition (compacted)**

In general, compaction problems occur when airspace drops to 10-15% of total soil volume. Compaction affects the infiltrating and water quality capacity of soils. When soils are compacted, the soil particles are pressed together, reducing the pore space necessary to move air and water throughout the soil. This decrease in porosity causes an increase in bulk density (weight of solids per unit volume of soil). The greater the bulk density, the lower the infiltration and therefore the larger volume of runoff.

Different types of soils have bulk density levels at which compaction starts to limit root growth. When root growth is limited, the uptake of water and nutrients by vegetation is reduced.

Soil organisms are also affected by compaction; biological activity is greatly reduced, decreasing their ability to intake and release nutrients.

The best soil restoration is the complete revegetation of woodlands, as “A mature forest can absorb as much as 14 times more water than an equivalent area of grass.” (DNREC and Brandywine Conservancy, 1997) (See Structural BMP 6.7.2 Landscape Restoration and use in combination with this BMP)

**Soil Restoration Methodology**

Soil restoration is a technique that can be used to restore and enhance compacted soils or soils low in organic content by physical treatment and/or mixture with additives such as compost. Soil restoration has been shown to alter soil properties known to affect water relations of soils, including water holding capacity, porosity, bulk density and structure. Two methods have been shown to restore some of the characteristics of soils that are damaged by compaction; tilling and addition of amendments such as compost or other materials.

One of the options for soil amendment is compost, which has many benefits. It improves the soil structure, creating and enhancing passageways in the soil for air and water that have been lost due to compaction. This recreates a better environment for plant growth. Compost also supplies a slow release of nutrients to plants, specifically nitrogen, phosphorous, potassium, and sulfur. Using compost reuses natural resources, reducing waste and cost.

Soil amendment with compost has been shown to increase nutrients in the soil, such as phosphorus and nitrogen, which provides plants with needed nutrients, reducing or eliminating the need for fertilization. This increase in nutrients results in an aesthetic benefit as turf grass and other plantings establish and proliferate more quickly, with less maintenance requirements. Soil amendment with compost increases water holding and retention capacity, improves infiltration, reduces surface runoff, increases soil fertility, and enhances vegetative growth. Compost also increases pollutant-binding properties of the soil properties, which improves the quality of the water passing through the soil mantle and into the groundwater.

The second method is tilling, which involves the digging, scraping, mixing, and ripping of soil with the intent of circulating air into the soil mantle in various layers. Compaction down to 20 inches often requires ripping for soil restoration. Tilling exposes compacted soil devoid of oxygen to air and recreates temporary air space.

Soil Texture	Ideal Bulk densities	Bulk densities that may affect root growth	Bulk densities that restrict root growth
	g/cm3	g/cm3	g/cm3
Sands, loamy sands	<1.60	1.69	1.8
Sandy loams, loams	<1.40	1.63	1.8
Sandy clay loams, loams, clay loams	<1.40	1.6	1.75
Silt, silt loams	<1.30	1.6	1.75
Silt loams, silty clay loams	<1.10	1.55	1.65
Sandy clays, silty clays, some clay loams (35-45% clay)	<1.10	1.49	1.58
Clays (>45% clay)	<1.10	1.39	1.47

*Source: Protecting Urban Soil Quality, USDA-NRCS*

Bulk density field tests may be used to determine the compaction level of soils.

## Variations

- Soil amendment media can include compost, sand, and manufactured microbial solutions.
- Seed can be included in the soil amendment to save application time.

## Applications

- **New Development (Residential, Commercial, Industrial)** – new lawns can be amended with compost and not heavily compacted before planting, to increase the porosity of the soils.
- **Urban Retrofits** - Tilling of soils that have been compacted before it is converted into meadow, lawn, or a stormwater facility is recommended.
- **Detention Basin Retrofits** – The inside face of detention basins is usually heavily compacted, and tilling the soil mantle on surfaces beyond the constructed embankment will encourage infiltration to take place. Tilling may be necessary to establish better vegetative cover.
- **Landscape Maintenance** – compost can substitute for dwindling supplies of native topsoil in urban areas.
- **Golf Courses** – Using compost as part of the landscaping upkeep on the greens has been shown to alleviate soil compaction, erosion, and turf disease problems.

## Design Considerations

1. Treating Compaction by **Soil Restoration**
  - a) Soil amendment media usually consists of compost, but can include mulch, manures, sand, and manufactured microbial solutions.
  - b) Compost should be added at a rate of 2:1 (soil:compost). If a proprietary product is used, the manufacturer's instructions should be followed in terms of mixing and application rate.
  - c) Soil restoration should not be used on slopes greater than 30%. In these areas, deep-rooted vegetation can be used to increase stability.
  - d) Soil restoration should not take place within the drip line of a tree to avoid damaging the root system.
  - e) On-site soils with an organic content of at least 5 percent can be properly stockpiled (to maintain organic content) and reused.
  - f) Procedure: rototill, or rip the subgrade, remove rocks, distribute the compost, spread the nutrients, rototill again.
  - g) Add 6 inches compost / amendment and till up to 8 inches for minor compaction.
  - h) Add 10 inches compost / amendment and till up to 20 inches for major compaction.
2. Treating Compaction by **Ripping / Subsoiling / Tilling / Scarification**
  - a) Subsoiling is only effective when performed on dry soils.
  - b) Ripping, subsoiling, or scarification of the subsoil should be performed where subsoil has become compacted by equipment operation, dried out and crusted, or where necessary to obliterate erosion rills.
  - c) Ripping (Subsoiling) should be performed using a solid-shank ripper and to a depth of 20 inches, (8 inches for minor compaction).

- d) Should be performed before compost is placed and after any excavation is completed.
- e) Subsoiling should not be performed within the drip line of any existing trees, over underground utility installations within 30 inches of the surface, where trenching/drainage lines are installed, where compaction is by design.

Subsoiling should not be performed with common tillage tools such as a disk or chisel plow because they are too shallow and can compact the soil just beneath the tillage depth.

3. Other methodologies:

- a) Irrigation Management – low rates of water should be applied, as over-irrigation wastes water and may lead to environmental pollution from lawn chemicals, nutrients, and sediment.
- b) Limited mowing – higher grass corresponds to greater evapotranspiration.
- c) Compost can be amended with bulking agents, such as aged crumb rubber from used tires or weed chips. This can be a cost-effective alternative that reuses waste materials.
- d) In areas where compaction is less severe (not as a result of heavy construction equipment), planting with deep-rooted perennials can treat compaction, however restoration takes several years.

**Table 2. Mean runoff from unvegetated test plots during a 30 minute high-intensity (~ 4 in/hr) rain storm**

	Biosolids	Yard Trimmings	Bio-industrial	Compacted Subsoil	Topsoil
Geometric mean runoff (mm) during 30-minute rainfall	0.13 <sup>a</sup>	<0.01 <sup>a</sup>	0.08 <sup>a</sup>	26.22 <sup>b</sup>	15.54 <sup>b</sup>

*Values with different letters are significantly different statistically (p<0.05) from one another.*

**Table 3. Mean time to initiate runoff from unvegetated test plots**

	Biosolids	Yard Trimmings	Bio-industrial	Compacted Subsoil	Topsoil
Mean time (min)	31.08 <sup>c</sup>	56.92 <sup>d</sup>	32.17 <sup>c,d</sup>	4.67 <sup>a</sup>	7.83 <sup>b</sup>

*Values with different letters are significantly different statistically (p<0.05) from one another.*

### Detailed Stormwater Functions

#### Infiltration Area (If needed)

The infiltration area will be the entire area restored, depending on the existing soil conditions, and the restoration effectiveness.

#### Volume Reduction Calculations

Soil Amendments can reduce the need for irrigation by retaining water and slowly releasing moisture, which encourages deeper rooting. Infiltration is increased; therefore the volume of runoff is decreased.

Compost amended soils can significantly reduce the volume of stormwater runoff. For soils that have either been compost amended according to the recommendations of their BMP, or subject to restoration such that the field measured bulk densities meet the Ideal Bulk Densities of Table 1, the following volume reduction may be applied:

$$\text{Amended Area (ft}^2\text{)} \times 0.50\text{in} \times 1/12 = \text{Volume (cf)}$$

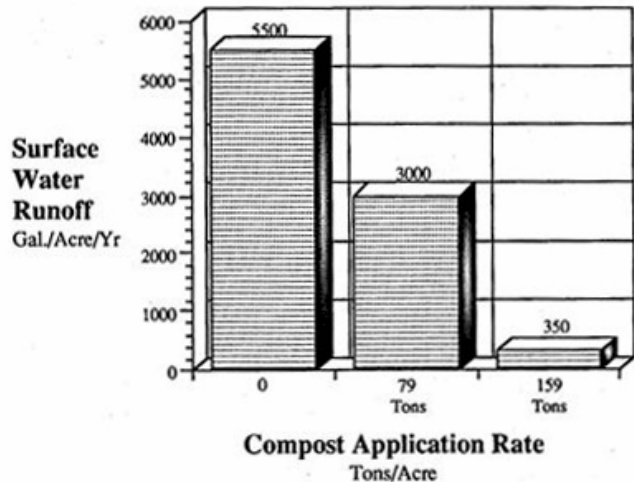
#### Peak Rate Mitigation

See Section 8 for peak rate mitigation.

#### Water Quality Improvement

See Section 8 for water quality improvement.

**Surface Water Runoff Rate - Austrian Vineyard Data  
Municipal Solid Waste Compost Application  
30% Slope**



**Table 4. Adsorbed Mass of Nutrients and Metals in Unvegetated Plot Runoff From 30-Minute, High-Intensity (100-mm/hr.) Rainstorm**

Element	Compost Treatments			Conventional Treatments	
	Biosolids	Yardwaste	Bioindustrial Compost	Compacted Subsoil	Topsoil
	Geometric Mean (mg)				
Chromium	0.01 <sup>d</sup>	<0.01 <sup>a</sup>	<0.01 <sup>d</sup>	0.92 <sup>c</sup>	0.76 <sup>e</sup>
Copper	0.02 <sup>b</sup>	<0.01 <sup>a</sup>	0.01 <sup>b</sup>	1.03 <sup>c</sup>	0.68 <sup>e</sup>
Nickel	<0.01 <sup>b</sup>	<0.01 <sup>a</sup>	<0.01 <sup>b</sup>	0.96 <sup>c</sup>	0.67 <sup>e</sup>
Lead	0.01 <sup>b</sup>	<0.01 <sup>a</sup>	<0.01 <sup>b</sup>	1.82 <sup>c</sup>	0.95 <sup>e</sup>
Zinc	0.10 <sup>b</sup>	<0.01 <sup>a</sup>	0.03 <sup>b</sup>	6.55 <sup>c</sup>	3.99 <sup>e</sup>
Nitrogen	0.47 <sup>b</sup>	<0.01 <sup>a</sup>	0.09 <sup>a,b</sup>	266.65 <sup>c</sup>	211.87 <sup>e</sup>
Phosphorus	0.45 <sup>b</sup>	<0.01 <sup>a</sup>	0.09 <sup>a,b</sup>	36.47 <sup>c</sup>	29.07 <sup>e</sup>
Potassium	0.17 <sup>b</sup>	<0.01 <sup>a</sup>	0.09 <sup>a,b</sup>	103.94 <sup>c</sup>	71.57 <sup>e</sup>

Means within the same row with different letter designations are significantly different (p<0.05).

Highest
Medium
Lowest



## Construction Sequence

1. All construction should be completed and stabilized before beginning soil restoration.

## Maintenance Issues

The soil restoration process may need to be repeated over time, due to compaction by use and/or settling. (For example, playfields or park areas will be compacted by foot traffic.)

## Cost Issues

Tilling costs, including scarifying sub-soils, range from \$800/ac to \$1000/ac.

Compost amending of soil ranges in cost from \$860/ac to \$1000/ac.

## Specifications

The following specifications are provided for information purposes only. These specifications include information on acceptable materials for typical applications, but are by no means exclusive or limiting. The designer is responsible for developing detailed specifications for individual design projects in accordance with the project conditions.

### 1. SCOPE

- a. This specification covers the use of compost for soil amendment and the mechanical restoration of compacted, eroded and non-vegetated soils. Soil amendment and restoration is necessary where existing soil has been deemed unhealthy in order to restore soil structure and function, increase infiltration potential and support healthy vegetative communities.
- b. Soil amendment prevents and controls erosion by enhancing the soil surface to prevent the initial detachment and transport of soil particles.

### 2. COMPOST MATERIALS

- a. Compost products specified for use in this application are described in Table 1. The product's parameters will vary based on whether vegetation will be established on the treated slope.
- b. Only compost products that meet all applicable state and federal regulations pertaining to its production and distribution may be used in this application. Approved compost products must meet related state and federal chemical contaminant (e.g., heavy metals, pesticides, etc.) and pathogen limit standards pertaining to the feedstocks (source materials) in which it is derived.
- c. Very coarse compost should be avoided for soil amendment as it will make planting and crop establishment more difficult.

- d. **Note 1** - Specifying the use of compost products that are certified by the U.S. Composting Council's Seal of Testing (STA) Program ([www.compostingcouncil.org](http://www.compostingcouncil.org)) will allow for the acquisition of products that are analyzed on a routine basis, using the specified test methods. STA participants are also required to provide a standard product label to all customers, allowing easy comparison to other products.

### 3. SUB-SOILING TO RELIEVE COMPACTION

- a. Before the time the compost is placed and preferably when excavation is completed, the subsoil shall be in a loose, friable condition to a depth of 20 inches below final topsoil grade and there shall be no erosion rills or washouts in the subsoil surface exceeding 3 inches in depth.
- b. To achieve this condition, subsoiling, ripping, or scarification of the subsoil will be required as directed by the owner's representative, wherever the subsoil has been compacted by equipment operation or has become dried out and crusted, and where necessary to obliterate erosion rills. Sub-soiling shall be required to reduce soil compaction in all areas where plant establishment is planned. Sub-soiling shall be performed by the prime or excavating contractor and shall occur before compost placement.
- c. Subsoiled areas shall be loosened to less than 1400 kPa (200 psi) to a depth of 20 inches below final topsoil grade. When directed by the owner's representative, the Contractor shall verify that the sub-soiling work conforms to the specified depth.
- d. Sub-soiling shall form a two-directional grid. Channels shall be created by a commercially available, multi-shanked, parallelogram implement (solid-shank ripper). The equipment shall be capable of exerting a penetration force necessary for the site. No disc cultivators, chisel plows, or spring-loaded equipment will be allowed. The grid channels shall be spaced a minimum of 12 inches to a maximum of 36 inches apart, depending on equipment, site conditions, and the soil management plan. The channel depth shall be a minimum of 20 inches or as specified in the soil management plan. If soils are saturated, the Contractor shall delay operations until the soil will not hold a ball when squeezed. Only one pass shall be performed on erodible slopes greater than 1 vertical to 3 horizontal. When only one pass is used, work should be at right angles to the direction of surface drainage, whenever practical.
- e. Exceptions to sub-soiling include areas within the drip line of any existing trees, over utility installations within 30 inches of the surface, where trenching/drainage lines are installed, where compaction is by design (abutments, footings, or in slopes), and on inaccessible slopes, as approved by the owner's representative. In cases where exceptions occur, the Contractor shall observe a minimum setback of 20 feet or as directed by the owner's representative. Archeological clearances may be required in some instances.

### 4. COMPOST SOIL AMENDMENT QUALITY

- a. The final, resulting compost soil amendment must meet all of the mandatory criteria in Table 4.

## 5. COMPOST SOIL AMENDMENT INSTALLATION

- a. Spread 2-3 inches of approved compost on existing soil. Till added soil into existing soil with a rotary tiller that is set to a depth of 6 inches. Add an additional 4 inches of approved compost to bring the area up to grade.
- b. After permanent planting/seeding, 2-3 inches of compost blanket will be applied to all areas not protected by grass or other plants

### References

"The Compaction of Urban Soils", Technical Note #107 from Watershed Protection Techniques, Article 36, 3(2): 661-665.

Dallas, H. and A. Lewandowski, 2003. Protecting Urban Soil Quality: Examples for Landscape Codes and Specifications. USDA Natural Resources Conservation Services.

OCSCD, 2001. *Impact of Soil Disturbance During Construction on Bulk Density and Infiltration in Ocean County, New Jersey*. Ocean County Soil Conservation District, Schnabel Engineering Associates, Inc., USDA Natural Resources Conservation Services. [www.ocscd.org](http://www.ocscd.org).

Pitt, R. et al., 2002. "Compacted Urban Soils Effects on Infiltration and Bioretention Stormwater Control Designs."

Pitt, R. et al., 2002. "Infiltration Through Disturbed Urban Soils and compost-Amended Soil Effects on Runoff Quality and Quantity."

"The Relationship Between Soil and Water", Soils for Salmon, The Urban Environment, 1999

"Soil Quality Resource Concerns: Compaction", USDA Natural Resources Conservation Service, 1996

"Soil Quality Resource Concerns: Available Water Capacity", USDA Natural Resources Conservation Service, 1998

"Specifications for Soil Amendments", Low Impact Development Center, Inc., [www.lid-stormwater.net/soilamend/soilamend\\_specs.htm](http://www.lid-stormwater.net/soilamend/soilamend_specs.htm)

"Urban Soil Compaction", Soil Quality – Urban Technical Note, No. 2, USDA Natural Resources Conservation Services, 2000.

Department of Natural Resources and Environmental Control Division of Soil and Water. *Delaware Erosion and Sediment Control Handbook for Development*. Newark, DE



## BMP 6.7.4: Floodplain Restoration

Floodplain restoration tries to mimic the interaction of groundwater, stream base flow, and root systems – key components of a stream corridor under pre-settlement (pre-1600s) conditions. Under pre-settlement conditions, typically the roots of the riparian vegetation on the floodplain were directly linked to the base flow elevation of the stream. Groundwater frequently interacted with the root zones and the stream’s base flow. Where the groundwater was lower than the stream’s base flow, the gravel-lined streams and permeable floodplains frequently reduced surface flows through infiltration. The interaction among the stream’s base flow, groundwater, permeable floodplain soils, and riparian root zones provides multiple benefits, including the filtering of sediments and nutrients through retention of frequent high flows onto the floodplain, removal of nitrates from groundwater, reduction of peak flow rates, groundwater recharge/infiltration, and increase of storage and reduction of flood elevations during higher flows. As a result of historical and recent human impacts, many stream networks have little interaction among the groundwater, stream base flow, and the root systems of floodplain vegetation. Frequently, recently deposited floodplain soils are cohesive, separating the root zones from base flow and allowing only minimal infiltration from the surface flow through the porous pre-settlement soils and gravels. Floodplain restoration as a BMP should be considered where there is minimal interaction among the key components. Other benefits of this BMP include thermal cooling of the stream base-flow, improved benthic community species diversity and habitat, re-establishment and significant increases of wetland areas and native plant species on the floodplain, reduction of invasive plant species, and increased aquatic habitat and riparian areas.

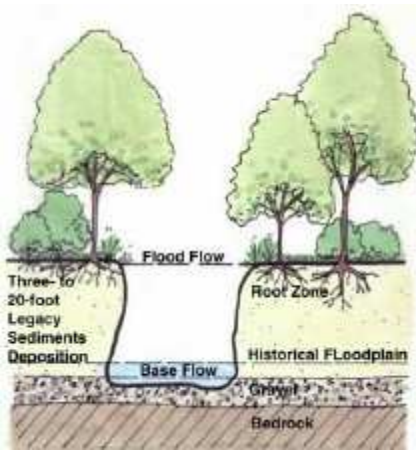
<p style="text-align: center;"><b><u>Key Design Elements</u></b></p> <ul style="list-style-type: none"> <li>▪ A natural, system-based BMP that uses native vegetation, soils, and other natural elements</li> <li>▪ Can be easily integrated into the initial site planning process Can prevent riparian problems from getting worse or can fix problems caused by historical practices</li> <li>▪ Can address numerous problems, from the site level to the watershed level</li> <li>▪ Provides multiple benefits of restoring a fluvial and riparian system to a fully functioning level of interaction</li> <li>▪ Re-connection of stream channel to functional floodplain</li> <li>▪ Incorporation of an aquatic and riparian system that interacts with the groundwater and/or stream base flow.</li> <li>▪ Reattachment of root systems of floodplain vegetation/riparian areas connected to groundwater and/or base flow.</li> <li>▪ Removal of “legacy sediments” and associated nutrients stored within the stream corridors prior to release through bank erosion.</li> </ul>	<p style="text-align: center;"><b><u>Potential Applications</u></b></p> <p>Residential: Yes                  Commercial: Yes                  Ultra Urban: Yes                  Industrial: Yes                  Retrofit: N/A                  Highway/Road: Yes</p>
	<p style="text-align: center;"><b><u>Stormwater Functions</u></b></p> <p>Volume Reduction: Low/High                  Recharge: Low/High                  Peak Rate Control: Medium                  Water Quality: Med/High</p>
	<p style="text-align: center;"><b><u>Water Quality Functions</u></b></p> <p>TSS: 85%                  TP: 85%                  NO3: &gt;30%</p>

## Description

Floodplain restoration as a BMP is an effective tool to meet water quality and quantity requirements, prevent riparian problems from getting worse, and fix current problems caused by historical practices. The interaction and connection of the groundwater, stream base flow, riparian vegetation root system, and permeable floodplain soils and gravels immediately reduce downstream sedimentation by stopping or greatly reducing stream bank and channel erosion. The “legacy sediments” stored in stream valleys create unnaturally high stream banks and floodplains that frequently contain massive amounts of nutrients, which are released during erosion. Additionally, high banks separate plant root zones from the nitrates in the stream base flow and groundwater. Thus, instead of nitrogen being removed by the plants, groundwater and base flow continue to transport nitrates to receiving waters. Floodplain restoration directly removes a significant source of phosphorus and sediments and creates a riparian/aquatic environment to provide effective denitrification. Additionally, a restored floodplain and stream may greatly enhance infiltration and storage of surface flow in the floodplain, which reduces flood flow stages, volumes, and peak discharges. Floodplain restoration is an effective technique to meet stormwater management initiatives. One of the great advantages of this technique is that it can address numerous problems, from the site-specific to the watershed-level. Floodplain restoration can prevent or substantially mitigate the full range of stormwater impacts in one BMP. It is a natural, system-based BMP that uses native vegetation, soil, and other natural features. Floodplain restoration reconnects a number of key components within a stream corridor so that their interaction protects the stability of the bed and channel while the system receives, holds, infiltrates, and filters sediment and nutrients from overland flow. These components include:

- a floodplain that receives more routine flows, thereby reducing erosive flow forces in the channel and allowing existing sediments and nutrients to remain in storage;
- a floodplain that allows vegetative root systems to interact with the base flow and/or groundwater, providing frequent removal of nitrates and effective stabilization of the stream banks and floodplain;
- a floodplain wide and flat along the valley bottom, consisting of the proper earthen materials to absorb surface flows and increase infiltration to groundwater;
- a plant community adapted to frequent inundation that will provide suitable habitat for riparian wildlife and whose root systems will provide nitrate and phosphate removal from surface and/or groundwater; and
- increased and improved habitat for aquatic resources.

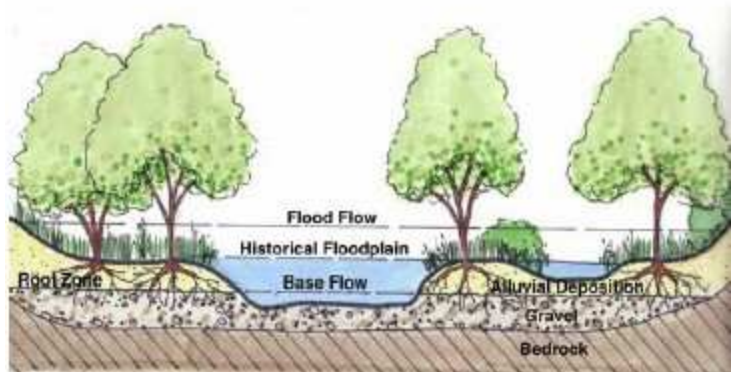
Traditional on-site BMPs focus on the development site itself, while floodplain restoration can focus not only on the development site but also on the receiving streams. Adding floodplain restoration to the toolbox also increases the flexibility to address onsite BMP limitations such as steep slopes, shallow bedrock, or property limitations.



**Existing Conditions:** Stream channels are eroding or have eroded back down through sediments that collected behind mill dams, leaving their alluvial terraces high above the current base flow water elevation, and disconnecting riparian root systems from groundwater flows. The processes of frequent floodplain inundation, which relieves in-channel stresses; groundwater infiltration through porous floodplain material, and nitrogen removal from groundwater through root systems are lost under these conditions that are prevalent today throughout the Piedmont region of the United States.

**Pre-settlement / Restored Conditions:**

Stable, pre-settlement stream and floodplain systems were characterized by: a low floodplain in close contact with surface water in the stream channel, allowing for frequent inundation of the floodplain during high flows; riparian vegetation with roots zones in contact with groundwater that enabled ground-water denitrification through root uptake; and a channel bed composed of cobble and gravel, which helped protect the underlying bedrock from erosive flow forces.



**Santo Domingo Creek, Lititz Run Watershed, Lancaster County, Pa.**

Top Left: Existing conditions.  
 Top Right: Restored conditions  
 Right: Riparian Wetland adjacent to channel.



## Variations

When implementing a Floodplain Restoration BMP, existing site constraints can influence the opportunity or potential to achieve all the benefits. Impacts to natural channels often create streambeds that are perched above the historical bed that existed prior to the 1600s. This is especially the case when historical milldams, creating significant backwater influences upstream of the physical dam, caused natural channels to fill with fine alluvial sediments from hillside erosion during the widespread land-clearing of the post-settlement era. When current streambeds are perched, it is often the case that the groundwater elevation is below the streambed. In this case, base flow, whether intermittent or perennial, flows on the perched streambed and has little interaction with the groundwater elevation below the streambed. The fine alluvial sediments that washed from the hillsides often act as a barrier, keeping the in-channel base flow and groundwater separated.

As a **first priority**, the design of a Floodplain Restoration BMP should attempt to establish the proposed streambed so that the base flow in the channel is connected to the pre-settlement streambed gravels and, typically, the groundwater elevation. This scenario provides the greatest benefit for nutrient uptake, because the newly established, active, vegetated root zone will be highly attached to the groundwater and base flows in the new active channel. Where cohesive soils or clays separate the top of the floodplain from the underlying porous material, these cohesive materials should be replaced with more porous soils. On sites where vertical constraints from existing infrastructure, such as roadway crossings, culverts, and utility crossings, prevent lowering the restored streambed to its historical pre-settlement elevation that would, in many cases, have been attached to the groundwater elevation, then a **second priority** to the Floodplain Restoration BMP should be utilized. The second priority shall be utilized where site constraints do not allow for the reconnection of the restored streambed to the groundwater elevation. In this case, the restored channel should be established such that the base flow or, in the case of an intermittent stream, the streambed is highly attached to the stream bank vegetated root zone, meaning that the established root zone extends down to the streambed elevation.

## Applications

**On-Site:** When a stream is located within or immediately adjacent to a proposed development site, the Floodplain Restoration BMP can be directly tied into the site development stormwater management plan, given the stream is in need of restoration as a stand-alone BMP or as a supplemental BMP to other stormwater BMP needs. **Off-Site:** On development projects that do not have a stream on or adjacent to the site, the Floodplain Restoration BMP may be implemented on the downstream receiving stream or within the watershed. Existing watershed prioritization studies may be useful in identifying appropriate sites for off-site applications of this BMP. In areas where existing wetlands or mature riparian forests or vegetation exist, this practice may not be applicable. The benefits of the practice must be weighed against the impact to determine if this method is acceptable.

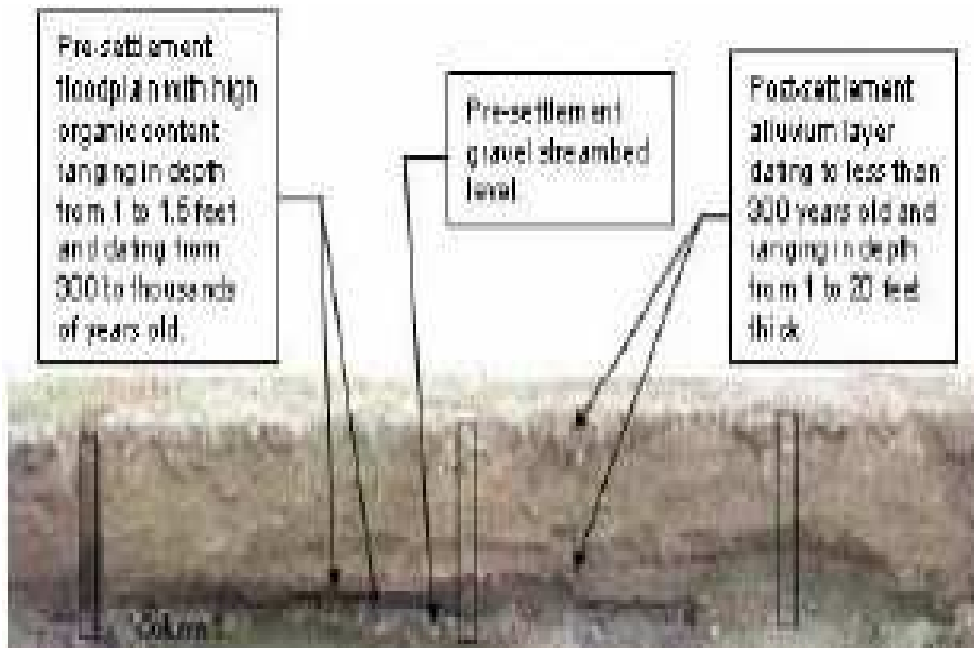


## Design Considerations

The goal of floodplain restoration is to re-establish the natural interaction of a stream system, including surface flow; groundwater; porous, organic floodplain soils; and vegetative roots systems by re-establishing the stream channel and adjacent floodplain in their natural valley-flat location such that it functions similarly to the pre-settlement conditions. Any restoration required for the stream channel itself should follow the guidelines established by the Keystone Stream Team in *Guidelines For Natural Stream Channel Design for Pennsylvania Waterways*.

General design procedures:

1. Determine if the vegetative root zone is connected to the base flow and groundwater or, in the case of an ephemeral stream, the stream bed. A simplified way to determine root zone connection is to examine the root depth of the vegetation on the floodplain or out-of-bank level along the active stream banks. If the base of the active root zone extends into the base flow or channel bed region, then the floodplain is likely to be attached to the active stream channel.
2. Excavate a trench(es) or perform geo probes along the existing floodplain to determine pre-settlement floodplain and streambed elevations. Typically, the buried pre-settlement floodplain consists of dark peat and organic material.



Trench excavated across the existing floodplain reveals the pre-settlement streambed and floodplain levels currently buried under post-settlement alluvium and facilitates soil layer analyses, including various dating procedures.

3. Identify any vertical constraints or limitations that may prevent the floodplain restoration from providing the interconnection of the key components described above.
4. If the channel bed exists at the groundwater or pre-settlement bed elevation, then lower the floodplain and re-establish the appropriate vegetation where the rooting depth is connected to the base flow and/or groundwater.
5. If downstream constraints such as utility crossings or culverts will not allow lowering the floodplain and stream bed to its pre-settlement elevation, and floodplain soils are porous, excavate the existing

floodplain soils to an elevation that allows the floodplain vegetative root systems to be connected to the base flow elevation.

6. If downstream constraints such as utility crossings or culverts will not allow lowering the floodplain and stream bed to its pre-settlement elevation, and floodplain soils are cohesive and non-porous, remove the clays and replace with more porous materials to an elevation that allows the floodplain vegetative root systems to be connected to the base flow elevation.
7. Hydrologic/hydraulic studies may be necessary as required.
8. Obtain federal, state, and local permits and coordinate with local floodplain regulations.
9. Accommodate multiple uses, such as greenways, trails, and other stormwater BMPs as pre-treatment or energy dissipation measures.
10. Based on preceding design procedures, excavate floodplain to proper elevation and provide vegetative stabilization of the restored floodplain area. Vegetation establishment is an integral part of a floodplain restoration. Vegetation will help reduce flow velocities, promote settling, provide nutrient uptake, provide filtering, limit erosion along streambanks, and prevent active channel short-circuiting in the floodplain. Robust, non-invasive, perennial plants that establish quickly are ideal for floodplain restoration. The designer should select native species that are tolerant of a range of conditions, such as those accustomed to saturated conditions, emergent and upland areas.

## Detailed Stormwater Functions

**Volume Reduction Calculations:** Floodplain restoration can achieve increased flood storage. Floodplain wetlands can attenuate smaller flows until the capacity of these wetlands is exceeded. The volume of soils removed as part of the floodplain restoration is now available for storage of flood flows and is capable of conveying flood flows at lower elevations, thus reducing water surface elevations and nuisance flooding.

**Peak Rate Mitigation Calculations:** Peak rate is primarily controlled through the infiltration of runoff and additional storage from runoff and receiving waters in the floodplain. Also, the shallow depth and high floodplain roughness can increase the travel time, reducing downstream peak rates.

**Water Quality Improvements:** Floodplain restoration will reduce the sediment load through the reduction of streambank erosion and the reconnection of the stream channel to a functional floodplain. A floodplain also promotes deposition of fine sediments and filtering of nutrients. Root zones attached to the base flow and groundwater remove nutrients during low flow or drought periods. The floodplain also acts as a riparian buffer or a vegetated filter strip filtering nutrients and sediment from overland runoff prior to waters entering the stream channel.

**Recharge:** The wide and flat area of the floodplain along the valley bottom should typically be porous, providing a large area for infiltration. In many “karst” or limestone areas, the channel bed may be significantly higher than the groundwater elevation. The channel and floodplain in these areas can provide significant groundwater recharge even during drought conditions. The floodplain/channel bed must consist of the proper earthen materials to absorb surface flows, increase infiltration to groundwater, and promote groundwater recharge.

## Construction Sequence

The Pennsylvania Keystone Stream Team has developed *Guidelines For Natural Stream Channel Design for Pennsylvania Waterways*, and Construction Considerations are discussed specifically in Chapter 8.

## Maintenance Issues

Floodplain restoration projects must have a maintenance plan that will address the condition of the channel and floodplain through the monitoring of the survivability of the riparian plan implemented with the restoration project. As discussed in the design considerations, vegetation establishment is paramount to the stability of streambanks and the floodplain. Vegetation established along the streambanks and within the floodplain should maintain a minimal 85 percent survival rate, which should be documented through the implementation of a monitoring plan.

Monitoring of the floodplain restoration should coincide with the regulatory requirements established by state and federal regulatory agencies. These monitoring requirements are typically established as a condition of the issuance of a permit to authorize the floodplain restoration activities.

### Weed and Invasive Plant Control

Weeds and invasive plants limit buffer growth and survival of native plants; therefore, weeds and invasive plants should be controlled by either herbicides, mowing, or weed mats. These techniques may need to be implemented after the first growing season and may need to continue into the fourth year after the implementation of the floodplain restoration.

### Herbicides

This is a short-term (two to three years) maintenance technique that is generally less expensive and more flexible than mowing and will result in a quicker establishment of the buffer. Herbicide use is regulated by the Pennsylvania Department of Agriculture. Proper care should be taken to ensure that proximity to water features is considered.

### Mowing

Mowing controls the height of the existing grasses yet increases nutrient uptake; therefore, competition for nutrients will persist until the canopy closure shades out lower layers. Mowing could occur twice each growing season. Mower height should be set between eight and 12 inches.

### Weed Mats

Weed mats are geo-textile fabrics that are used to suppress weed growth around newly planted vegetation by providing shade and preventing seed deposition. Weed mats are installed after planting, and should be removed once the trees have developed a canopy that will naturally shade out weeds. Once established, the floodplain restoration project should require little to no long-term maintenance.

## Cost Issues

The Pennsylvania Keystone Stream Team has developed preliminary cost ranges associated with the assessment, design, permitting, and implementation of floodplain restoration projects. They can be found at the Keystone Stream Team website: <http://www.keystonestreamteam.org/>.

## Specifications

Floodplain restoration designs need to accommodate the sediment loads of the watershed without aggrading or degrading. Guidelines for floodplain restoration projects can be found in the Keystone Stream Team's *Guidelines for Natural Stream Channel Design for Pennsylvania's Waterways* (March 2003).

## References

*Guidelines For Natural Stream Channel Design for Pennsylvania Waterways*, Chapter 8, Keystone Stream Team, March 2003.

Cost Ranges Outline, Keystone Stream Team website: [www.keystonestreamteam.org](http://www.keystonestreamteam.org)  
*Northern Lancaster County Groundwater Study: A Resource Evaluation of the Manheim-Lititz and Ephrata Area Groundwater Basins*, Edwards, Robert E. and Pody, Robert D., Susquehanna River Basin Commission, Publication No. 235, September 2005.

Santo Domingo Creek Sediment & Nutrient Load Study, Lititz Borough, Lancaster County, PA, [www.landstudies.com](http://www.landstudies.com), LandStudies, Inc., October 2004.

“Back to the Future”: Stream Corridor Restoration and Some New Uses for Old Floodplains, [www.landstudies.com](http://www.landstudies.com), LandStudies, Inc. March 2004.

Sediment and Soil Site Investigation, Merritts, Dorothy, Ph.D., Walter, Robert, Ph.D., DeWet, Andrew, Ph.D., Franklin & Marshall College, January 2005.

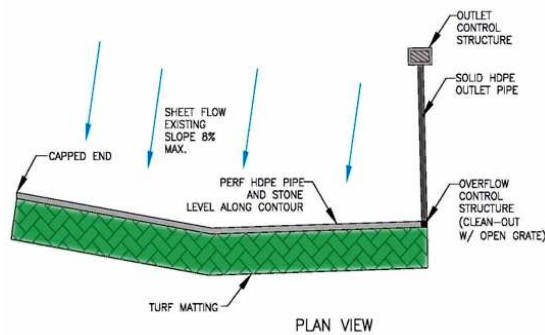


## **6.8 Other BMPs and Related Measures**

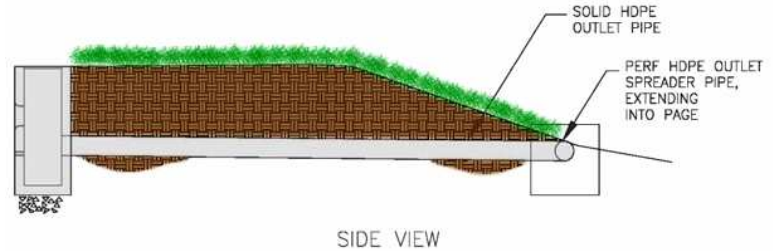




## BMP 6.8.1: Level Spreader



Level Spreaders are measures that reduce the erosive energy of concentrated flows by distributing runoff as sheet flow to stabilized vegetative surfaces. Level Spreaders, of which there are many types, may also promote infiltration and improved water quality.



<p style="text-align: center;"><b><u>Key Design Elements</u></b></p> <ul style="list-style-type: none"> <li>▪ Level spreaders must be level.</li> <li>▪ Specific site conditions, such as topography, vegetative cover, soil, and geologic conditions must be considered prior to design; level spreaders are not applicable in areas with easily erodible soils and/or little vegetation.</li> <li>▪ Level spreaders should safely diffuse at least the 10-year storm peak rate; bypassed flows should be stabilized in a sufficient manner.</li> <li>▪ Length of level spreaders is dependent on influent flow rate, pipe diameter (if applicable); number and size of perforations (if applicable), and downhill cover type.</li> <li>▪ It is always easier to keep flow distributed than to redistribute it after it is concentrated; multiple outfalls/level spreaders are preferable to a single outfall/level spreader.</li> </ul>	<p style="text-align: center;"><b><u>Potential Applications</u></b></p> <p>Residential: Yes                  Commercial: Yes                  Ultra Urban: Limited                  Industrial: Yes                  Retrofit: Yes                  Highway/Road: Yes</p>
	<p style="text-align: center;"><b><u>Stormwater Functions</u></b></p> <p>Volume Reduction: Low                  Recharge: Low                  Peak Rate Control: Low                  Water Quality: Low</p>
	<p style="text-align: center;"><b><u>Water Quality Functions</u></b></p> <p>TSS: 20%                  TP: 10%                  NO3: 5%</p>

## Description

Ensuring distributed, non-erosive flow conditions is an important consideration in any stormwater management strategy and particularly critical to the performance of certain BMPs (e.g. filter strips). Level spreading devices diffuse flows (both low and high), promote infiltration, and improve water quality by evenly distributing flows over a stabilized vegetated surface. There are many different types and functions of level spreaders. Examples include concrete sills (or lips), curbs, earthen berms, and level perforated pipes.

For the purposes of the Manual, there are essentially two categories of level spreaders. The first type of level spreader (Inflow) is meant to evenly distribute flow entering into another structural BMP, such as a filter strip, infiltration basin, or vegetated swale. Examples of this type of level spreader include concrete sills (or lips), curbs, and earthen berms. The second type of level spreader (Outflow) is intended to reduce the erosive force of low to moderate flows while at the same time enhancing natural infiltration opportunities. Examples of this second type include a level, perforated pipe in a shallow aggregate trench (similar to an Infiltration Trench) and earthen berms. While the first type of level spreader can be a very effective measure, it is already discussed in some detail as a design consideration in other structural BMPs and particularly in BMP 6.4.10 Infiltration Berms. This section therefore, focuses primarily on the second category of level spreaders.

Outflow level spreaders are often used in conjunction with other structural BMPs, such as BMP 6.4.2 Infiltration Basins and BMP 6.4.3 Subsurface Infiltration Bed. However, in certain situations, they can be used as “stand alone” BMPs to dissipate runoff from roofs or other impervious areas. In either case, level spreaders might account for some level of volume and rate reduction, the degree to which depends on the specific design, natural infiltration rate of the soil, amount of influent runoff, vegetation density and slope of downhill area, and extent (length of level spreader). Specific credit, as defined in BMPs 5.8.1 and 5.8.2, is given to stand alone level spreaders for impervious areas greater than 500 square feet.

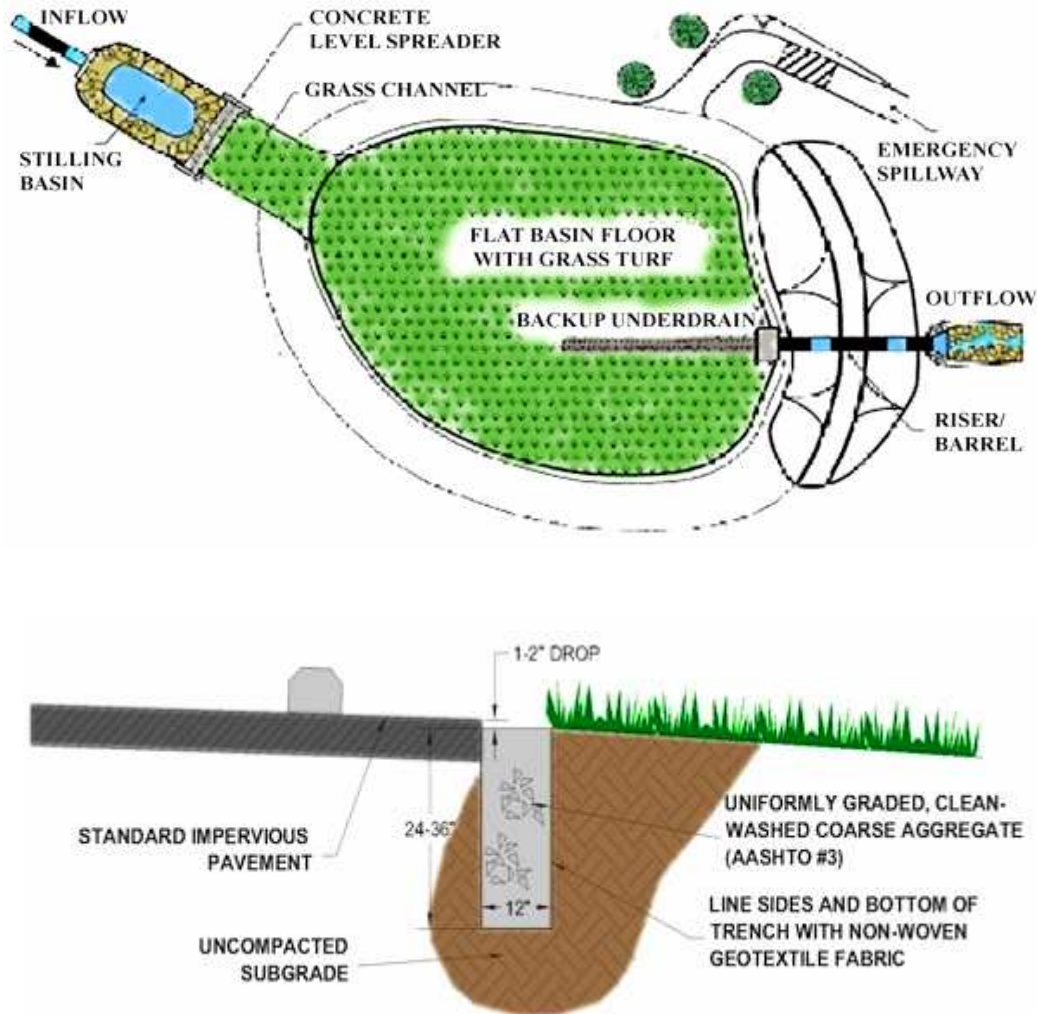
A typical level spreader that is used in conjunction with another structural BMP is a level perforated pipe in a shallow aggregate trench. Though the actual design will vary, a “level spreader pipe” should be designed to at least distribute to the 10-year storm. Depending on the computed flow rate and available space, the designer may provide enough length of pipe to distribute the 100-year storm (see Design Considerations). If space is limited, then flows above the 10-year storm may be allowed to bypass the level spreader. The level spreader pipe must be installed evenly along a contour at a shallow depth in order to ensure adequate flow distribution and discourage channelization. In some cases, a level spreader pipe may be “upgraded” to an Infiltration Trench if additional volume and rate reduction is required (see BMP 6.4.4, Infiltration Trench).

The condition of the area downhill of a level spreader should be considered prior to installation. For instance, the slope, density and condition of vegetation, natural topography, and length (in the direction of flow) will all affect the effectiveness of a distributed flow measure. Areas immediately downhill from a level spreader may need to be stabilized, especially if they have been recently disturbed. Erosion control matting and/or compost blanketing are the recommended measures for achieving permanent downhill stabilization. Permanent vegetative stabilization should be in place prior to placing the level spreader into operation. Manufacturer’s specifications should be followed for chosen stabilization measure.

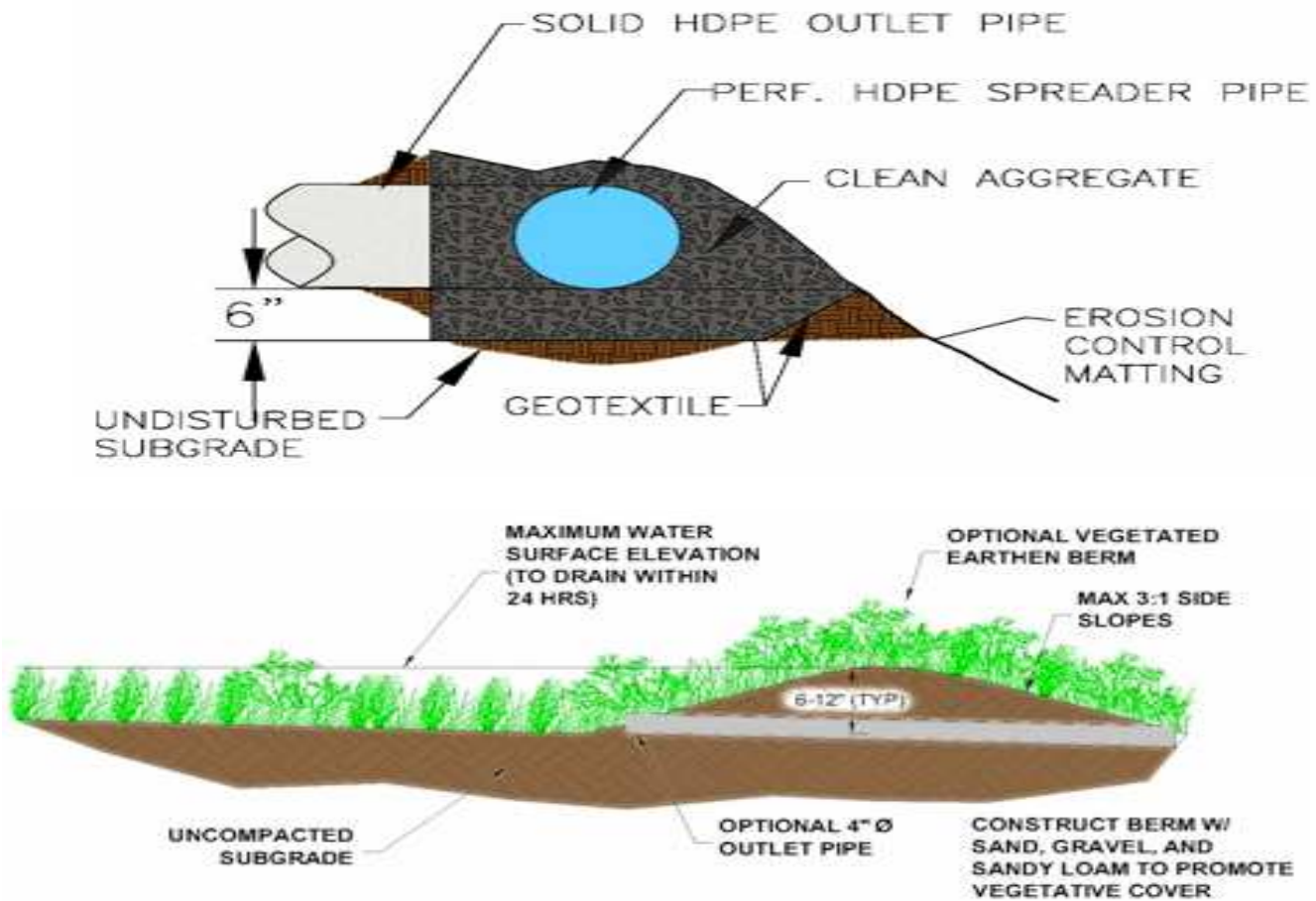
### Variations

- Inflow Level Spreaders**

Evenly distribute flow entering into another structural BMP, such as a filter strip or infiltration basin. Examples include concrete sills (or lips), curbs, concrete troughs, ½ pipes, short standing PVC-silt fence, aggregate trenches, and earthen berms (see Infiltration Berms and Filter Strips). To ensure even distribution of flow, it is critical that these devices be installed as levelly as possible. More rigid structures (concrete, wood, etc.) are often preferable to earthen berms, which have the potential to erode.



- Outflow Level Spreaders (in conjunction with structural BMP)**  
 Reduces the erosive force of low to moderate flows while at the same time enhancing natural infiltration opportunities. Examples include a level perforated pipe in a shallow aggregate trench (similar to an Infiltration Trench) and earthen berms.



- Outflow Level Spreader (stand alone)**  
 Distribute runoff from roofs or other impervious areas of 500 square feet or less. Unless modified to approximate an Infiltration Trench, stand-alone level spreaders do not usually account for substantial volume or rate reductions. However, if designed and installed properly, they still represent effective flow diffusion devices with some water quality benefits.

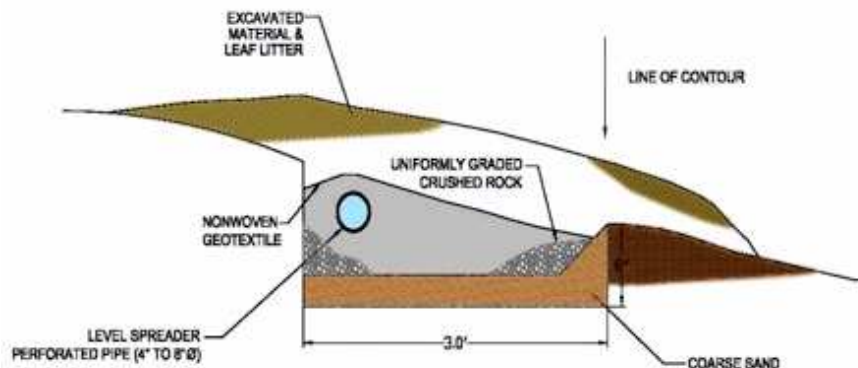


## Applications

- **Ultimate outlet from structural BMPs not discharging directly to a receiving stream**
- **Roof downspout connections (roof area < 500sf)**
- **Inlet connections (impervious area < 500sf)**
- **Inflow to structural BMP, such as filter strip, infiltration basin**

## Design Considerations

1. It is usually preferable to not initially concentrate stormwater and provide as many outfalls as possible. This can reduce or even eliminate the need for devices to provide even distribution of flow.
2. Receiving soils and land cover should be undisturbed or stabilized with vegetation or other permanent erosion-resistant material prior to receiving runoff. Level spreaders are not applicable in areas with easily erodable soils and/or little vegetation. The slope below the level spreader should be relatively smooth in the direction of flow to discourage channelization. The minimum flow length of the receiving area should be 75 feet.
3. For design considerations of earthen berm level spreaders refer to BMP 6.4.10 Infiltration Berm.
4. Level spreaders should not be located in constructed fill. Virgin soil is much more resistant to erosion than fill.
5. Level spreaders should not be used for sediment removal. Significant sediment deposition in a level spreader will render it ineffective.
6. A perforated pipe level spreader may range in size from 4 to 12 inches in diameter. The pipe should be laid in an envelope of AASHTO #57 stone, the thickness of which is based upon the desired volume reduction. A deeper trench will provide additional volume reduction and should be included in the calculations (see BMP 6.4.4 Infiltration Trench). Non-woven geotextile should be placed below the aggregate to discourage clogging by sediment.



7. The length of level spreaders is primarily a function of the calculated influent flow rate. The level spreader should be long enough to freely discharge the calculated peak flow rate. At a minimum, the peak flow rate shall be that resulting from a 10-year/24-hour design storm. This flow rate should be safely diffused without the threat of failure (i.e. creation of erosion gullies or rills). Diffusion of the storms greater than the 10-year/24-hour storm is permissible if space permits. Generally, level spreaders should have a minimum length of ten feet and a maximum length of 200 feet.

Conventional level spreaders designed to diffuse all flow rates should be sized based on the following:

For grass or thick ground cover vegetation:

- a) 13 linear feet of level spreader for every 1 cfs flow
- b) Slopes of 8% or less from level spreader to toe of slope

For forested areas with little or no ground cover vegetation:

- a) 100 linear feet of level spreader for every 1 cfs flow
- b) Slopes of 6% or less from level spreader to toe of slope

Determining the perforation discharge per linear foot of pipe may further refine the length of a perforated pipe level spreader. A level spreader pipe shall safely discharge in a distributed manner at the same rate of inflow. Perforated pipe manufacturers' specifications provide the discharge per linear foot of pipe, though it is typically based on the general equation for flow through an orifice. Manufacturer's specifications can be used to find the right combination of length and size of pipe. If the number of perforations per linear foot (based on pipe diameter) and average head above the perforations are known, then the flow can be determined by the following equation:

$$L \text{ (length of level spreader pipe)} = Q / Q_L$$

$Q_L$  (discharge per linear foot) =  $Q_O$  \* # of perforations per linear foot of pipe (provided by manufacturer, based on perforation diameter)

$$Q_O \text{ (perforation flow rate)} = C_d * A * (2 * g * H)^{0.5}$$

$Q_O$  = the free outfall flow rate through one perforation (ft<sup>3</sup>/sec)

$C_d$  = Coefficient of discharge (typically 0.60)

$A$  = Cross sectional area of one perforation (ft<sup>2</sup>)

$g$  = 32.2 ft/sec<sup>2</sup>

$H$  = head, average height of water above perforation (ft) (provided by manufacturer)

For example, the 10- and 100-year design flows for a site were determined to be 2 and 5 cfs, respectively. Assuming a 12-in diameter pipe with thirty-six 0.375-in. diameter perforations per linear foot and an H value of 0.418 feet, the discharge per linear foot is calculated at 0.086 cfs/ft. When the two design flows are divided by the discharge per linear foot, the resulting required lengths are 24 and 59 feet, respectively.

This calculation assumes a free flow condition. Since the level spreader pipe is encased in aggregate (which is around 40% void space) this assumption is usually acceptable. However, for this reason and to account for the potential for clogging of perforations over time, the length of pipe should be multiplied by minimum factor of safety of 1.1.

- 8. Flows (> 10-year storm peak rate) may bypass a level spreader in a variety of ways, including an overflow structure or up-turned ends of pipe. (The ends of the perforated pipe could be turned uphill at a 45-degree angle or more with the ends screened.) Cleanouts/overflow structures with open grates can also be installed along longer lengths of perforated pipe. The designer shall provide stabilization measures for bypassed flows in a manner consistent with the Pennsylvania Erosion and Sedimentation Pollution Control Program Manual.
- 9. Erosion control matting or compost blanketing is recommended immediately downhill and along the entire length of the level spreader, particularly in those areas that are unstable or have been recently disturbed by construction activities. Generally, low flows that are diffused by a level spreader do not require additional stabilization on an already stabilized and vegetated slope. The installation requirements for erosion control methods will vary according to the manufacturer's specifications.

There are a variety of permanent erosion control alternatives to riprap currently on the market. Turf/reinforcement matting is a manufactured product that combines vegetative growth and synthetic materials to reduce the potential for soil erosion on slopes. It is typically made of synthetic materials that will not biodegrade and will create a foundation for plant roots to take hold, extending the viability of grass beyond its natural limits.

Compost blankets are an emerging technology that serves a similar function to permanent erosion control matting. When compost is applied as a "blanket" over a disturbed area, it encourages a thicker, more permanent vegetative cover due to its ability to improve the infrastructure of the soil. Compost blankets reduce runoff volume by holding water in its pores and improve water quality by binding and degrading specific chemical contaminants.



## Detailed Stormwater Functions

### Volume Reduction Calculations

In general, level spreaders do not substantially reduce runoff volume. However, for level spreaders designed similar to Infiltration Trenches, a volume reduction can be achieved. Also, for level spreaders serving as stand-alone BMPs (for contributing impervious up to 500 square feet), volume reduction credits, as discussed in BMPs 5.8.1 and 5.8.2, can be achieved for runoff disconnection. The true amount of volume reduction will depend on the length of level spreader, the density of vegetation, the downhill length and slope, the soil type of the receiving area, and the design runoff. Large areas with heavy, dense vegetation will absorb some flows, while barren or compacted areas will absorb limited amounts of runoff. See Section 9 for detailed calculation methodologies.

### Peak Rate Mitigation Calculations

The influent peak rate to a level spreader will be diffused (or dissipated) over the length of the level spreader; the number of perforations in a level spreader pipe will essentially divide the concentrated flow into many smaller flows. To be conservative, and to allow for the possibility of re-convergence, the peak rate should be taken prior to diffusion from the level spreader. See Section 9 for detailed calculation methodologies.

### Water Quality Improvement

Water quality improvements occur if the area down gradient of the level spreader is vegetated, stabilized, and minimally sloped. See Section 9 for Water Quality Improvement methodology, which addresses pollutant removal effectiveness of this BMP.

## Construction Sequence

1. Level spreaders are considered a permanent part of a site's stormwater management system. Therefore, the uphill development should be stabilized before diverting runoff to any dispersing flow techniques. If the level spreader is used as an erosion and sedimentation control measure, it must be reconfigured (flush perforated pipe, clean out all sediment), to its original state before use as a permanent stormwater feature.
2. All contributing stormwater elements (infiltration beds, inlets, outlet control structures, pipes, etc) should be installed.
3. Perforated pipe should be installed along a contour, with care taken to construct a level bottom. The pipe can be underground in a shallow infiltration trench (see Infiltration Trench for design guidance), or closer to the surface and covered with a 12-inch thick layer of AASHTO #57 stone. If the perforated pipe is in a trench, excavate to the design dimensions. If the pipe is to be at or near the surface, some minor excavation or filling may be necessary to maintain a level bottom.
4. If necessary, install erosion control matting along the length of the level spreader and to a distance downhill, as specified by the manufacturer/supplier. Cover the pipe with AASHTO #57 stone.
5. For construction sequence of earthen berms, see BMP 6.4.10 Infiltration Berm.



## Maintenance Issues

Compared with other BMPs, level spreaders require only minimal maintenance efforts, many of which may overlap with standard landscaping demands. The following recommendations represent the minimum maintenance effort for level spreaders:

- Catch Basins and Inlets draining to a level spreader should be inspected and cleaned on an annual basis.
- The receiving land area should be immediately restored to design conditions after any disturbance. Vegetated areas should be seeded and blanketed.
- It is critical that even **sheet flow conditions** are sustained throughout the life of the level spreader, as their effectiveness can deteriorate due to lack of maintenance, inadequate design/location, and poor vegetative cover.
  - **Inspection** - The area below a level spreader should be inspected for clogging, density of vegetation, damage by foot or vehicular traffic, excessive accumulations, and channelization. Inspections should be made on a quarterly basis for the first two years following installation, and then on a semiannual basis thereafter. Inspections should also be made after every storm event greater than 1-inch.
  - **Removal** - Sediment and debris should be routinely removed (but never less than semiannually), or upon observation, when buildup occurs in the clean outs. Regrading and reseeded may be necessary in the areas below the level spreader. Regrading may also be required when pools of standing water are observed along the slope. (In no case should standing water be allowed for longer than 72 hours.)
  - **Vegetation** - Maintaining a vigorous vegetative cover on the areas below a level spreader is critical for maximizing pollutant removal efficiency and erosion prevention. If vegetative cover is not fully established within the designated time, it may need to be replaced with an alternative species. (It is standard practice to contractually require the contractor to replace dead vegetation.) Unwanted or invasive growth should be removed on an annual basis. Biweekly inspections are recommended for at least the first growing season, or until the vegetation is permanently established. Once the vegetation is established, inspections of health, diversity, and density should be performed at least twice per year, during both the growing and non-growing season. Vegetative cover should be sustained at 85% and replaced if damage greater than 50% is observed.

## Cost Issues

As there are various types of level spreaders, their associated costs will vary. Per foot material and equipment cost will range from \$5 to \$20 depending on the type of level spreader desired. Concrete level spreaders may cost significantly more than perforated pipes or berms. (For more detailed cost information in BMP 6.4.4 Infiltration Trenches and BMP 6.4.10 Infiltration Berms.)

## Specifications

The following specifications are provided for information purposes only. These specifications include information on acceptable materials for typical applications, but are by no means exclusive or limiting. The designer is responsible for developing detailed specifications for individual design projects in accordance with the project conditions.

1. **Stone** shall be 2-inch to 1-inch uniformly graded coarse aggregate, with a wash loss of no more than 0.5%, AASHTO size number 3 per AASHTO Specifications, Part I, 19th Ed., 1998, or later and shall have voids <sup>3</sup> 35% as measured by ASTM-C29.
2. **Non-Woven Geotextile** shall consist of needled non-woven polypropylene fibers and meet the following properties:
  - a. Grab Tensile Strength (ASTM-D4632) <sup>3</sup> 120 lbs
  - b. Mullen Burst Strength (ASTM-D3786) <sup>3</sup> 225 psi
  - c. Flow Rate (ASTM-D4491) <sup>3</sup> 95 gal/min/ft<sup>2</sup>
  - d. UV Resistance after 500 hrs (ASTM-D4355) <sup>3</sup> 70%
  - e. Heat-set or heat-calendared fabrics are not permitted  
Acceptable types include Mirafi 140N, Amoco 4547, and Geotex 451.
3. **Topsoil** amend with compost (See BMP 6.7.3, Soil Amendment & Restoration)
4. **Pipe** shall be solid or continuously perforated, smooth interior, with a minimum inside diameter of 4-inches. High-density polyethylene (HDPE) pipe shall meet AASHTO M252, Type S or AASHTO M294, Type S.
5. **Vegetation** see Native Plant List in Appendix B.

## References

Maine Department of Transportation, 1992. *Maine Department of Transportation BMP Manual for Erosion and Sedimentation Control.*

NC Division of Water Quality. *Level Spreader Design Suggestions.* October 10, 2001.

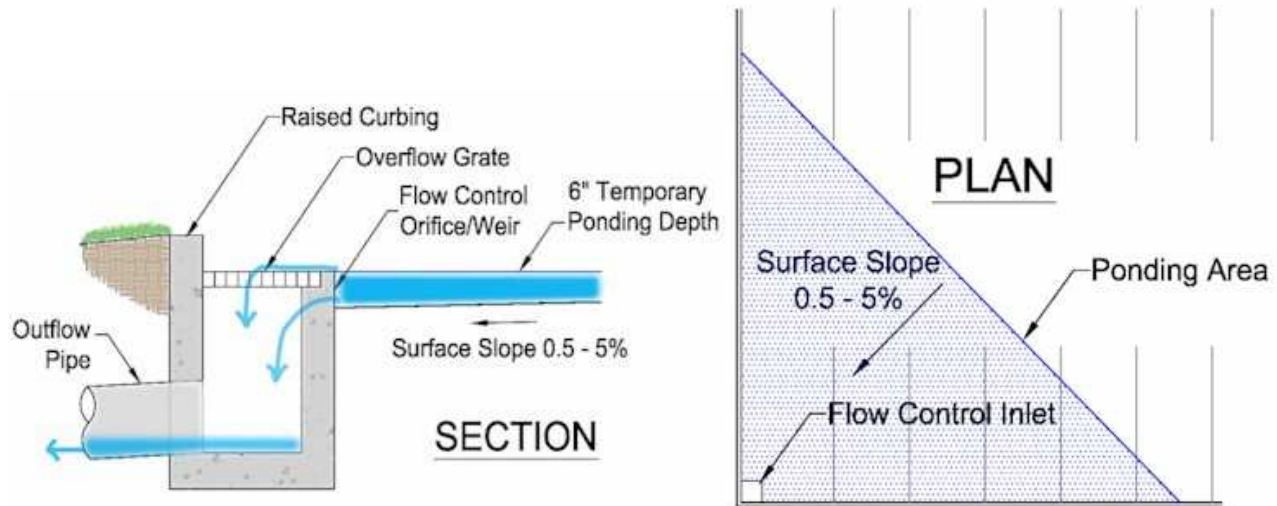
Idaho Department of Environmental Quality. *Idaho Catalog of Stormwater BMPs.*

Auckland Regional Council, 2003. *Stormwater Management Devices: Design Guidelines Manual,* Auckland, New Zealand

US EPA, NPDES, *Construction Site Storm Water Runoff Control – Permanent Diversions*

Designing Level Spreaders to Treat Stormwater Runoff (W.F. Hunt, D.E. Line, R.A. McLaughlin, N.B. Rajbhandari, R.E. Sheffield; North Carolina State University, 2001.)

## BMP 6.8.2: Special Detention Areas – Parking Lot, Rooftop



Areas such as parking lots and rooftops that are primarily intended for other uses but that can be designed to temporarily detain stormwater for peak rate mitigation.

<p style="text-align: center;"><b><u>Key Design Elements</u></b></p> <ul style="list-style-type: none"> <li>▪ Almost entirely for peak rate control</li> <li>▪ Water quality and quantity are not addressed</li> <li>▪ Short duration storage; rapid restoration of primary uses</li> <li>▪ Minimize safety risks, potential property damage, and user inconvenience</li> <li>▪ Emergency overflows</li> <li>▪ Maximum ponding depths</li> <li>▪ Flow control structures</li> <li>▪ Adequate surface slope to outlet</li> <li>▪ Waterproofing (rooftop storage)</li> </ul>	<p style="text-align: center;"><b><u>Potential Applications</u></b></p> <p>Residential: Limited                  Commercial: Yes                  Ultra Urban: Yes                  Industrial: Yes                  Retrofit: Yes                  Highway/Road: Limited</p> <hr/> <p style="text-align: center;"><b><u>Stormwater Functions</u></b></p> <p>Volume Reduction: Very Low                  Recharge: Very Low                  Peak Rate Control: Med./Low                  Water Quality: Low</p> <hr/> <p style="text-align: center;"><b><u>Water Quality Functions</u></b></p> <p>TSS: 0%                  TP: 0%                  NO3: 0%</p>
--	---

## Description

Special Detention Areas are places such as parking lots and rooftops that are primarily intended for other uses but that can be designed to temporarily detain stormwater for peak rate mitigation. Generally detention is achieved through the use of a flow control structure that allows runoff to temporarily pond. In most cases, ponding depths should be kept less than one foot. Special Detention Areas can be very effective at reducing peak rates of runoff but do little in terms of water quality and almost nothing to reduce the volume of runoff. Therefore, Special Detention Areas should be combined with other BMPs that address water quality, quantity, and groundwater recharge.

## Variations

Special Detention is especially suited for:

- Large gently-sloping parking lots



- Flat rooftops



- Recessed plazas



- Athletic fields



## Applications

Detention areas can be created in parking lots in depressed areas or along curbs by controlling flow at stormwater inlets and/or using raised curbing. Rooftop runoff storage can be achieved by restricting flow at scuppers, drains, parapet wall openings, etc. Recessed plazas and athletic fields can be designed with detention through the use of flow control structures and/or berms (for fields). Special Detention Areas can be used effectively to attenuate flows reaching other BMPs and thereby increase their performance; they can also be used to meet release rate requirements from Act 167 plans or municipal ordinances.

## Design Considerations

### 1. General

- a. Emergency overflows should be designed to prevent excessive depths from occurring during extreme events or if the primary flow control structures are clogged. Emergency overflows should be designed to safely convey flows downstream.
- b. Storage areas should be adequately sloped towards outlets to ensure complete drainage after storm events.
- c. Flow control structures should be designed to discharge stored runoff in a timely manner so that the primary use of the area can be restored.
- d. Care should be taken to ensure against ice build-up in the pooled area.

### 2. Parking Lot Storage

- a. Locate storage in areas so that ponding will not significantly disrupt typical traffic or pedestrian flow. Remote areas of large commercial parking lots, overflow parking areas, and other under-utilized parking areas are prime locations.
- b. Minimize potential safety risks and property damage due to ponding. Detention areas should be identified with signage or pavement markings or their use should be restricted during storms.
- c. Storage depths must be no greater than 1 foot.
- d. The area used for detention should be sloped towards the flow control structure at a least 0.5% to ensure adequate drainage after storms. Slopes greater than 5% tend to be inefficient because storage volume is much lower for a given ponding depth.

### 3. Rooftop Storage

- a. The roof structure must be able to support the additional load created by ponded water. Most roofs designed for snow load will be able to support runoff storage.
- b. Ponding depths should generally be less than 6 inches and stored water should not cause damage to any HVAC equipment on the roof.
- c. The areas utilized for storage must have adequate waterproofing.
- d. Emergency overflows can be provided by openings in the parapet wall or by additional drains.

## Detailed Stormwater Functions

### Volume Reduction Calculations

Special Detention Areas generally do not achieve significant volume reduction.

### Peak Rate Mitigation Calculations

Peak rate of runoff is reduced in Special Detention Areas through the transient storage provided. See in Section 9 for Peak Rate Mitigation methodology.

### Water Quality Improvement

Although they may provide some quality improvement through settling, Special Detention Areas do not appreciably address water quality.

## Construction Sequence

Not applicable.

## Maintenance Issues

Special Detention Areas generally require little maintenance. Maintenance activities should include semiannual inspection and cleaning of flow control structures, clearing debris/sediment from detention areas (as necessary), and inspecting waterproofing in rooftop storage areas.

## Cost Issues

Special Storage Areas can be a very economical means of reducing peak rates of runoff because they require little additional material and take up no additional space on a site.

## Specifications

The following specifications are provided for information purposes only. These specifications include information on acceptable materials for typical applications, but are by no means exclusive or limiting. The designer is responsible for developing detailed specifications for individual design projects in accordance with the project conditions.

### 1. Flow Control Structures

- a. Flow control structures shall be constructed of non-corrodible material.
- b. Structures shall be resistant to clogging by debris, sediment, floatables, plant material, or ice.
- c. Materials shall comply with applicable specifications (PennDOT or AASHTO, latest edition)

### 2. Waterproofing

- a. Waterproofing shall prevent all water migration into the building.
- b. Waterproofing must comply with applicable state and local building codes.
- c. Waterproofing shall have an expected service life of at least 25 years.

## References

2001, Georgia Stormwater Management Manual; Volume Two: Technical Handbook

2003, Ontario Stormwater Management Planning & Design Manual

Iowa Statewide Urban Design Standards Manual

1992, Michigan - Index of Individual BMPs





---

# **Pennsylvania Stormwater Best Management Practices Manual**

---

## **Chapter 7**

### **Special Management Areas**

**(Brownfields, Highways and Roads, Karst Areas,  
Mined Lands, Water Supply Well Areas, Surface  
Water Supplies and Special Protection Waters)**





**Chapter 7. Special Management Areas**

**7.1 Introduction.....1**

**7.2 Brownfields.....1**

**7.2.1 Site Remediation (i.e. Cleanup)..... 2**

**7.2.2 Site Redevelopment.....2**

**7.3 Highways and Roads.....3**

**7.3.1 Roadway Runoff Quality Issues.....4**

**7.3.2 BMP Considerations For Roadways.....5**

**7.3.3 Specific BMP Considerations.....9**

**7.3.4 Dirt and Gravel Roads.....10**

**7.4 Karst Areas.....11**

**7.4.1 The Nature of Karst.....11**

**7.4.2 Infiltration vs. non-infiltration.....12**

**7.4.3 Basic Principles.....13**

**7.4.4 BMP Considerations.....15**

**7.5 Mined Lands.....16**

**7.6 Stormwater Management Near Water Supply Wells.....17**

**7.7 Surface Water Supplies and Special Protection Waters.....20**

**7.8 Urban Areas.....21**

**7.8.1 Highly Impervious Urban Land.....21**

**7.8.2 Urban Water Quality.....22**

**7.8.3 Other Urban Stormwater Management Considerations.....24**

**7.9 References.....25**



## Special Management Areas (Brownfields, Highways and Roads, Karst Areas, Mined Lands, Water Supply Well Areas, Surface Water Supplies and Special Protection Waters)

### 7.1 Introduction

The non-structural and structural BMPs described in the preceding Chapters provide measures that mitigate the additional volume, pollutant load and increased rate of runoff produced by land development. Some land surfaces, however, will not be compatible with the application of certain BMPs. Successful compliance with the Control Guidelines described in Chapter 3 should still be possible for most new land development sites, but the range of measures available may be limited. In fact, some types of BMPs may be totally unsuitable for consideration in these special land areas and should be excluded from application.

The land use types considered as “Special Management Areas” are very different from each other, but all are places where land disturbance can alter the original natural environment. This land use type, past or present, above or below the surface, will dictate which BMPs are suitable.

### 7.2 Brownfields

Brownfields are real property, the expansion, redevelopment, or reuse of which may be complicated by the presence or potential presence of hazardous substances, pollutants, or contaminants. Cleaning up and reinvesting in these properties takes development pressures off of undeveloped, open land, and both improves and protects the environment. (Source: <http://www.epa.gov/brownfields/>)



Pennsylvania encourages private cleanups of contaminated properties and the return of those sites to productive use. It has developed programs such as the Act 2 – Land Recycling Program, which was envisioned as an integral part of a sound land use policy that would help prevent the needless development of prime farmland, open space areas and natural areas; and the Brownfield Action Team, which expedites the remediation, reclamation, reuse and redevelopment of brownfield lands. It is important to point out that this section of the manual is applicable to all cleanup sites, not just those that enter the Act 2 Program – which is a voluntary program.

Smart growth encourages the redevelopment of brownfield properties as pedestrian friendly, transit-accessible properties, built compactly with a mixture of land uses, and with access to public spaces, parks or plazas. Use of smart growth principles in brownfield redevelopment can create greater benefits from the reuse of infill sites, reduce demand for land for development on the urban fringe, and improve the air and water quality of the regions in which they are applied. Brownfield redevelopment is an essential component of smart growth, as both seek to return abandoned and underutilized sites to their fullest potential as community and economic assets.

Brownfield sites have a wide range of complexity, primarily dependent on previous, existing and proposed land use. Land development at brownfield sites normally occurs in two stages: (1) site remediation and (2) redevelopment. Planning, design and construction work associated with these two stages typically involve separate consultants and/or contractors. There are very few practitioners who perform both stages of work. This bifurcation of responsibility can potentially lead to miscommunication, mistakes and problems. It is critical that both parties coordinate and are mutually agreeable to the proposed activities at the site.

When applying for permits for a brownfield site (for either stage), it is imperative that the applicant provide full disclosure, including but not limited to the following information:

1. Existing and previous land uses
2. Potential pollutants, along with a summary of sampling data.
3. Source and location of the potential pollutant(s) on the Erosion and Sediment Control (E&S) Plan drawings,
4. A description of what measures are proposed to manage and control discharges of these pollutants to eliminate the potential for pollution to surface waters of the Commonwealth.

### **7.2.1 Site Remediation (i.e. Cleanup)**

The site remediation stage does not typically generate new impervious surfaces. In fact, remediation may reduce impervious area through the demolition of buildings and other impermeable surfaces. These areas, along with other earthmoving related to the cleanup, are usually temporarily stabilized until the site is redeveloped. As a result, this stage of land recycling does not typically require structural infiltration stormwater BMPs. The focus of site remediation routinely involves earthmoving to address soil and groundwater contamination. The stormwater management portion of this work is normally limited to non-structural BMPs, consisting of detailed construction sequencing or other measures to prevent the transport of contaminated runoff from the site.

How stormwater is managed on brownfield sites depends largely on how the site was remediated. Contaminated soil can be completely removed from the site, contaminated soil can be isolated and capped, or contaminated soil can be blended with clean soil so that it meets state standards for public health and safety. For more information on site remediation, go to: [www.depweb.state.pa.us](http://www.depweb.state.pa.us).

### **7.2.2 Site Redevelopment**

Most of the site improvements occur in the redevelopment stage. It is imperative that this stage of the project does not disturb any completed work from the site remediation stage (e.g. a cap or other cleanup remedy). Conflicts most frequently arise during the foundation work or utility work phases of a project. Utility lines, in particular, are often overlooked and can have a major impact by opening new preferential pathways for contaminants to migrate. Each stage should be considered independently; ideally, the remediation work should be completed prior to commencing redevelopment work.

The redevelopment stage is where any net increase of impervious area would be expected to occur; thereby leading to increases in the rate and volume of stormwater runoff. Even where there is no net increase in impervious area, the existing site is usually devoid of any notable stormwater management BMPs. This is the stage where post-construction stormwater management must be addressed.

All stormwater management options are available for use on brownfield sites where the contaminated soil has been completely removed from the site. Emphasis should be placed on minimizing the amount of earth disturbance area and soil compaction, minimizing the creation of impervious area, maximizing stormwater infiltration, and dispersing runoff to a number of BMPs scattered around the site rather than conveying and concentrating runoff to just a few locations.

For the less severe cases, a brownfield redevelopment can follow the same track as a conventional land development project, provided that certain precautions are taken. To facilitate this process, the applicant should clearly identify on their plan drawings where “hot spot” areas are known to exist and any associated remediation that may have occurred. The project consultants should prepare this vital information during the site remediation stage. Except for structural stormwater infiltration BMPs, the stormwater management options listed in this manual are also available for use on brownfield sites where contaminated soil is isolated and sealed, or the contaminated soil was blended with clean soil. Since soil contaminants are still present at these sites, the use of structural stormwater infiltration BMPs should be used only if the residual soil contaminants are non-soluble pollutants.

Precipitation and some runoff can be infiltrated through lawn and landscaped areas. These areas should be designed to have a layer of topsoil at least 8 inches thick. The topsoil should contain sufficient decomposed organic material (10 percent by dry weight is recommended in the Stormwater Management Manual for Western Washington) to provide cation exchange capacity to remove pollutants.

**Bio-retention** provides good options for water quality BMPs on all sites, including brownfield sites. Bio-retention coupled with infiltration should be considered on brownfield sites where all soil contaminants have been removed during remediation, or where only non-soluble contaminants remain. On brownfields where soluble contaminants are still present in the soil, bio-retention BMPs should be designed so that all water passing through the planting soil is directed to an overflow and not permitted to infiltrate.

**Vegetated roofs** can be used effectively on brownfield sites to retain much of the rainwater that falls on the roof. This BMP is very effective in areas where subsurface systems are not feasible. Stormwater can also be retained in basins or landscaped ponds and allowed to evaporate.

**Cisterns** and vertical storage units can be placed in corners of structured parking lots, inside buildings, on the outside walls of buildings, in adjacent alleys, alongside elevator shafts, and other locations deemed feasible by the designer. Vertical storage is particularly applicable to urban areas where space is at a premium. The shape and location of this BMP requires very little land area. Water collected this way can be re-used for things such as fire suppression, drip irrigation, lawn sprinkling, cooling buildings, toilet flushing and recreational water.

Chapter 6 of this manual provides more detailed information on these structural BMPs.

### 7.3 Highways and Roads

The purpose of this section is to consider the most suitable BMPs for managing runoff from roadways. Consideration of roadway design, construction, and maintenance should be included in the selection of BMPs that minimize the rate and volume, and enhance the quality of roadway runoff.

Mitigating the impacts of runoff from highways and roads is a concern for highway managers (such as PennDOT and the PA Turnpike Commission) and for municipalities; particularly those tasked with stormwater management and NPDES Phase II responsibilities. Highways and roads face specific challenges in managing stormwater, including:

- The need to manage stormwater while maintaining safe road conditions
- Limited available space and the need to locate BMPs within the right-of-way, if possible.
- Drainage area imperviousness greater than 50 percent, and sometimes 100%.
- Areas of extensive disturbance and compaction of soils (cut and fill).
- The potential for spills of hazardous materials.
- The use of deicing chemicals and salts as well as anti-skid materials, and the need to dispose of removed snow.
- Higher concentration of pollutants as compared to many other land uses.
- Thermal impacts to receiving streams in both summer and winter.

Pennsylvania ranks eighth in the country in terms of "total road and street" miles (<http://www.fhwa.dot.gov>), with a total of over 120,000 road miles, including over 18,000 miles of dirt and gravel roads. The intersection of these roads with the 86,000 miles of rivers and streams in Pennsylvania warrants careful consideration by stormwater managers and roadway designers alike.

### 7.3.1 Roadway Runoff Quality Issues

Highway and roadway runoff has been identified as a significant source of stormwater pollutants (Bannerman, et al 1993), as well as a significant source of thermal pollution to receiving waterways (Bush, et al 1974). The chemical constituents of roadway runoff are highly variable. The Federal Highway Administration (FHWA, 1999, Ultra-urban) identifies a number of roadway runoff pollutants and possible sources (Table 7-1). The FHWA also summarizes the concentrations of typical constituents found in highway runoff as outlined in Table 7-2. In comparison to other land uses and impervious surfaces, roadway runoff tends to have higher levels of sediment and suspended solids, which must be taken into consideration when selecting BMPs. Roadway runoff may also contain salts, deicing materials, and metals that can affect both receiving waters and vegetation and must be considered in BMP selection.

In addition to the chemical water quality issues associated with roadway runoff, exaggerated temperatures may also affect water quality. Roadway systems may deliver large amounts of warm or cold water directly and rapidly to receiving streams and wetlands, resulting in significant temperature extremes that could be harmful to fish and other aquatic life. Studies have shown that the runoff from summer storm events may exceed 90 degrees F, and winter runoff may be 37 degrees F colder than the receiving stream ambient temperature (Galli, 1990, Pluhowski, 1970). Such wide temperature differentials can have profound impacts on the aquatic systems of a receiving stream, and significantly alter and reduce the native aquatic life and its diversity. Stormwater collection and conveyance systems, and stormwater BMPs, should be designed with consideration of the potential thermal impacts on receiving waters due to runoff from road surfaces. Extended detention basins, in particular, should be designed to reduce this potential as discussed below.



Table 7-1 Constituents and Sources in Highway Runoff \*

Constituent	Source
Particulates	Pavement wear, vehicles, atmospheric deposition, maintenance activities
Nitrogen, Phosphorus	Atmospheric deposition and fertilizer application
Lead	Leaded gasoline from auto exhausts and tire wear
Zinc	Tire wear, motor oil and grease
Iron	Auto body rust, steel highway structures such as bridges and guardrails, and moving engine parts
Copper	Metal plating, bearing and bushing wear, moving engine parts, brake lining wear, fungicides and insecticides
Cadmium	Tire wear and insecticide application
Chromium	Metal plating, moving engine parts, and brake lining wear
Nickel	Diesel fuel and gasoline, lubricating oil, metal plating, bushing wear, brake lining wear, and asphalt paving
Manganese	Moving engine parts
Cyanide	Anti-caking compounds used to keep deicing salts granular
Sodium, Calcium Chloride	Deicing salts
Sulphates	Roadway beds, fuel, and deicing salts

\* From FHWA Stormwater Best Management Practices in an Ultra-Urban Setting

Table 7-2. Constituents of Highway Runoff

Parameter	Concentration (mg/L)
Total Suspended Solids (TSS)	45 - 798
Volatile Suspended Solids (VSS)	4.3 - 79
Total Organic Carbon (TOC)	24 - 77
Chemical Oxygen Demand (COD)	14.7 - 272
Biochemical Oxygen Demand (BOD)	12.7 - 37
Nitrate + Nitrite (NO <sub>3</sub> + NO <sub>2</sub> )	0.15 - 1.636
Total Kjeldahl Nitrogen (TKN)	0.335 - 55.0
Total Phosphorus as P	0.113 - 0.998
Copper (Cu)	0.022 - 7.033
Lead (Pb)	0.073 - 1.78
Zinc (Zn)	0.056 - 0.929
Fecal coliform (organisms/100 ml)	50 - 590

### 7.3.2 BMP Considerations for Roadways

While many of the BMPs discussed in this manual are appropriate for use in managing roadway runoff, these BMPs should be designed and implemented with consideration to the nature of runoff from road surfaces. Specifically:

1. Roadway runoff generates higher levels of suspended solids than most other urban land uses. Roadway runoff should not be discharged directly to infiltration systems without first reducing sediment loads. Infiltration BMPs are appropriate for roadway systems but must be designed in conjunction with a measure (structural or non-structural) that reduces the amount of sediment in roadway runoff prior to infiltration. There are a variety of options that will reduce sediment loads, including:
  - a. Vegetated systems such as grassed swales, filter strips, and bioretention;
  - b. Structural elements such as catch basin inserts, filters, and manufactured treatment units; and
  - c. Maintenance measures such as street sweeping and vacuuming.

Using some or all of these measures before discharging to an infiltration BMP will minimize the accumulation of sediment that could lead to failure of an infiltration BMP. All measures for sediment reduction require regular maintenance.

2. Vegetative BMPs such as grassed swales and filter strips can be highly effective in reducing pollutant loads from roadways but must be properly designed in terms of slope, flow velocity, flow length, and vegetative cover (Barrett, et al, 1997). Improperly designed or maintained systems may contribute to pollutant load, rather than reduce it.
3. The potential for spills must be considered. It is cost prohibitive to design for spill containment on all sections of roadway, but the designer should certainly consider the potential for spills and the necessary action should a spill occur. Subsurface systems, infiltration systems, or vegetative systems may require replacement should a spill occur. While this may seem to be a limiting factor in the use of such systems, many existing storm sewers from roadways discharge directly to receiving streams with no opportunity to contain or mitigate a spill before discharge to a receiving stream. Therefore, while BMP restoration may be required after a spill, the potential for a direct stream discharge of the contaminated substance will be greatly reduced or eliminated.
4. The use of deicing materials and salts, as well as anti-skid materials, may affect vegetation, soil conditions, and water quality. Consideration should be given to the types of vegetation used in vegetative BMPs, as high chloride levels may adversely affect some vegetation as well as the soil microbial community. Proximity to water supply sources should also be considered when designing infiltration BMPs, and the potential for groundwater chloride levels to be impacted by roadway runoff should be considered. Consideration must also be given to the disposal of snow removed from roadways. This snow may ultimately be deposited in BMP areas and may contain higher concentrations of roadway salts and sediments. The potential impacts of this material on the BMP should be considered in the design process.
5. Temperature extremes of runoff from roadways can significantly affect receiving stream aquatic habitat. Roadways, especially asphalt roadways, tend to absorb heat and lack cooling vegetation. Many existing storm sewers from roads discharge directly and immediately to receiving waters. New discharges should provide mitigation for temperature impacts prior to discharge to the receiving water. This may involve:
  - a. Vegetated systems and buffers to replace sections of concrete swales or pipes that impart heat to runoff. Use of multiple small drainage elements that use

- vegetated swales for conveyance can help reduce the temperature impacts from roadway runoff.
- b. If extended detention systems, wet ponds, or constructed wetlands are used for peak rate mitigation, the discharge from these systems should be further mitigated by the use of vegetated swales or buffers, as these impoundments may also create adverse temperature impacts (SWRCB 2002; Oberts 1997). The discharge from an extended detention system should be conveyed by a vegetated swale, or dispersed through a level spreader, wherever practicable. Discharges should not be routinely piped directly into receiving streams or wetlands.
  - c. Extended detention systems should include design elements (Table 7-3) to attenuate runoff temperature. Recommended techniques (FWW, Young, et al 1996) include:
    1. Designing the system with minimal permanent pool;
    2. Preserving existing shade trees and planting fast growing trees along the shoreline, but not on the constructed embankment;
    3. Aligning ponds in a north-south direction; and
    4. Avoiding excessive riprap and concrete channels that impart heat to runoff.

Table 7-3. Impacts and Mitigation Measures for use of extended detention basins (Young, et al. 1996)

Environmental Issue	Diligent Responses
Need to avoid an existing wetland	Perform wetland delineation before sitting pond.
	Select pond systems with minimal permanent pool.
	Adjust pond configuration.
	Install parallel pipe system to divert runoff around wetland to pond site sited further downstream.
	Construct ponds around the wetland.
Need to preserve mature forest or habitat area	Configure pond to minimize the removal of specimen trees.
	Limit the area of disturbance.
	Mandate tree protection measures during construction.
	Plant native trees and shrubs to replicate habitat functions lost due to pond.
Concern about the thermal impact of pond on downstream fishery	Select system with minimal permanent pool.
	Preserve existing shade trees, plant fast-growing shade trees along the shoreline.
	Align pond north-south direction.
	Avoid excessive riprapping and concrete channels that rapidly impart heat to runoff.
	Maximize detention and/or increase first flush amount to runoff greater than first 13 mm of rain.
Need to protect stream reach above pond from urban storm flows	Install parallel pipe system along the upstream reach to convey excessive storm flows.
	Install plunge-pools at terminus of storm drains to reduce runoff velocities.
	Use bioengineering techniques and check dams to stabilize the stream reach.

## PENNDOT Program and Recommendations

As the primary state agency charged with construction, operation and maintenance of the major roadways in the Commonwealth, the PA Dept. of Transportation has worked to develop a strategy to address two related issues. The immediate impact created by earthwork and disturbance during new construction, considered as Erosion and Sediment Control (E&S), is the subject of the recent Manual produced by the Department (PENNDOT E&S Manual, 2004). The long-term problems of stormwater runoff, discussed here, remains as a major issue. In discussions with PADEP, a set of strategies have been developed as follows:

- Use sod-forming grasses adjacent to the roadway shoulders and for vegetated swales to serve as filters for suspended solids and metals.
- Use non-invasive native species vegetation (or plant species that are known to take up and store certain contaminants) in lawn areas, on slopes and within wetland reconstruction/banking areas to enhance water uptake and the storage of certain pollutants in plant tissue.
- Limit the use of curb-gutter sections as much as practical for filtering and temperature considerations.
- Limit the use of storm sewers as much as practical for filtering and temperature considerations.
- Consider bioretention capability in the design of new detention basins (Dry Extended Detention Basin design).
- Monitor the effectiveness of existing constructed wetlands, updating the current design practices as necessary.
- Consider alternative methods of energy dissipation (in-lieu of rock pads) at culvert and storm sewer outfalls for temperature considerations.
- Where practical, discharge storm sewers into wetland areas or vegetated swales instead of discharging directly to streams for filtering and temperature considerations.
- Consider vegetated islands in-lieu of concrete islands (where practical for maintenance considerations) for filtering and temperature considerations.
- Consider the inclusion of infiltration berms and retentive grading in areas that are down slope of the roadway.
- Continue efforts to monitor and minimize the volume of winter maintenance materials utilized to minimize pollutant loadings within the runoff and into the groundwater.
- Continue efforts to protect all salt storage and loading areas from weather influences in efforts to minimize pollutant loadings.

- Consider practices to dilute flows where high concentrations of salts are anticipated to minimize pollutant loadings.
- Consider porous pavement and other subsurface infiltration methodologies on Department park-and-ride sites and for Department building site parking areas.
- Consider dry wells and other subsurface infiltration methodologies for Department building roof drains.

### **7.3.3 Specific BMP Considerations:**

#### **Limited Access Highways, Interstates and Turnpikes (Principal Arterials)**

Highways are usually designed with shoulders and often include vegetated medians, presenting prime areas for BMP implementation. Infiltration opportunities may be limited due to compaction and fill, as the right-of-way is often subject to significant grading changes to meet highway design standards. However, infiltration should not be precluded, and should be considered on a case-by-case basis.

The use of vegetated swales and buffer strips is highly recommended to reduce sediment loads from highways, but the possible impact on sight distances and roadway visibility must be considered, with planting design sensitive to this height issue. Vegetated swales and buffer strips can be combined with subsurface infiltration trenches or small infiltration/bioretention basins for volume reduction and temperature mitigation. For example, strips of vegetated swales that are underlain by infiltration trenches can provide both quality treatment and volume reduction, and replace concrete channels and pipe systems. Numerous small bioretention systems can provide peak rate mitigation and be incorporated into the right-of-way.

#### **New Streets and Residential Roads**

New streets and roads in residential and commercial developments provide the greatest opportunity to incorporate both non-structural and structural BMPs to address road runoff. Non-structural BMPs include:

- Reduced street widths
- Reduction or elimination of curbs and gutters
- Reduction of storm sewer infrastructure

Structural residential road systems include:

- Vegetated swales and infiltration trenches along the right-of-way
- Bioretention areas along the roadway
- Bioretention or bio-infiltration in cul-de-sacs
- Porous pavement
- Infiltration trenches along the contour that are perpendicular to the road
- Catch basin inserts or treatment devices

In new development, the roads and driveways often comprise the greatest amount of impervious area, sometimes as much as 70% of the total impervious area. Techniques that seek to manage the roadway runoff where it is generated, and reduce piping and conveyance of stormwater, should be implemented to the greatest extent possible.

## **Bridges**

Grit and oil removal BMP's should be considered for addressing stormwater discharging from scuppers serving bridge decks. If the inclusion of grit and oil removal BMP's is not feasible due to design constraints, more frequent "street cleaning" of the bridge deck should be made part of the project's Operation and Maintenance plan.

### **7.3.4 Dirt and Gravel Roads**

A significant portion of the state is served by unpaved roadways constructed of various types of gravel base, constructed over time and with locally available materials. While not constructed with AC impervious pavement, these roadways serve as stormwater conveyance pathways, creating significant erosion in the process and requiring constant maintenance to restore shoulders.

Pennsylvania has over 18,000 miles of unpaved roads. These roads consist of dirt and or gravel, and have historically been undermaintained compared to paved roads. These roads are frequently a source of pollution to streams and rivers in a drainage area, especially for sediment. This pollution occurs as precipitation carries sediment eroded from these roads and adjacent banks along the road surface and into open water. Statewide, while runoff from these roads is not the major source of pollution in streams, close proximity of rural roads to high quality streams is common, and these roads often parallel streams and discharge directly into them. Others have culverts that convey large amounts of water before discharging at high rates, following long downhill grades to a stream crossing. Adequate drainage is essential to the longevity of these roads, but environmentally sensitive practices for discharge of this drainage will benefit the health of the surrounding environment.

Pennsylvania's Dirt & Gravel Road Pollution Prevention Program was formed in 1997 to "fund environmentally sound maintenance of unpaved roadways that have been identified as sources of dust and sediment pollution." This program strives to reduce erosion, sediment, and dust pollution by using improved maintenance techniques that benefit both dirt and gravel roads and the environment. This program is centered on using local control as a method of stopping pollution. To date, at least 1400 projects have been completed under this program, and over 3,500 people have participated in the program's two day "Environmentally Sensitive Maintenance." Training course. Eligible dirt and gravel road sections are those identified by County Conservation District personnel as having a sediment source from the road polluting a stream.

Program initiatives include identifying and replacing pipes running beneath unpaved roads that are undersized and contribute to "ponding" on the road. The program also has developed a GIS (Geographical Information Systems) database, which tracks the location and status of all the dirt and gravel roads in PA, and allows the local entities to submit electronic reports directly to the State Conservation Commission. In 2000, data from over 17,000 miles of unpaved roads was compiled and resulted in over 11,000 verified pollution sites found. In addition to this, the

program is undergoing an aggregate study in Centre County, PA to determine the most economical and durable stone for gravel roads.

Local Municipalities and state agencies have jurisdiction of over 90% of dirt and gravel roads, and because the cost of paving these roads is often too high for the road owner, there are several best maintenance practices that can be employed to maintain an unpaved road in an environmentally sensitive manner. Recommendations include:

- Working with the natural landscape in the design of roads (minimize cut and fill)
- Identifying existing drainage patterns and designing to minimize disturbance
- Crowning the road to drain the water away from the center
- Using graders with scarified blades as preferred equipment to reshape a road
- Sizing roadside ditches appropriately and outletting appropriately within an infiltration design
- Driving Surface Aggregate mix should have increased abrasion resistance, be angular on the surface with increased fines to provide stability and facilitate compaction (stone quality matters)
- Vegetating roadside banks to prevent erosion
- Using snowplow shoes when clearing snow and re-shaping the road after snow season
- Preserving soil stabilizing vegetation in ditches and observing appropriate roadside vegetation management practices along road corridors
- Limiting driving speeds

Reduced road maintenance costs (grading, regrading, & re-graveling), and reduced sedimentation in water affecting aquatic life and drinking water reservoirs, should result from the implementing these measures, and are consistent with the various BMPs discussed in this manual. A detailed listing of technical bulletins and further information on “Environmentally Sensitive Maintenance” practices for dirt and gravel roads is available from the Center for Dirt and Gravel Road Studies at Penn State University ([www.dirtandgravelroads.org](http://www.dirtandgravelroads.org)).

## 7.4 Karst Areas

### 7.4.1 The Nature of Karst

**Surface-Water Interaction:** Water is a key to sinkhole collapses. Taking water away from where it was or putting a new, concentrated source of water where it wasn't before can speed the development of sinkholes. Examples of new sources of water could be drainage from rain gutters, pavement, collection ditches and ponds. Treatment basins or lagoons must be diligently lined in karst to prevent a sudden drainage out of the bottom and into the groundwater. Leaky water and sewer pipes can cause the soil underneath to wash away and are often the trigger for sinkholes. However, an existing sinkhole under a pipe can cause the initial leak. The greater the volume of water and the faster it moves into the karst system, the more soft material is washed from the voids. Weather events can also trigger sinkholes. In Pennsylvania, sinkholes can “pop” when a heavy rain event comes after a prolonged drought.

Karst areas present problems to those attempting to work with conventional hydrologic models. Typically, modeling of a karst site or watershed via SCS or other traditional methods provides poor representation of runoff rates, with regard to both flooding and over-design of conduits and stormwater management facilities. This is largely because standard hydrologic modeling methods lack allowances for losses into sinkholes, fractures, crevices or caves that may exist in the

carbonate units. Neither do models typically account for the stormwater that joins surface runoff as “interflow” when the collective capacity of interconnected conduits and cavities in the subsurface is exceeded. (Source: **Technical Bulletin No. 2** Virginia Department of Conservation and Recreation - Hydrologic Modeling and Design in Karst)

Karst loss is a term given to surface runoff loss into bedrock strata in areas underlain by limestone formations. Unlike other calculation factors, such as curve numbers (which deal with characteristics of the land surface), a karst loss factor is intended to depict projected losses into bedrock. The determination of karst potential in any given area may be simplified by the observation of noticeable indicators such as caves, crevices, limestone outcrops, sink holes, ponds that appear to lack sufficient contributing area, and disappearing streams. In other cases, karst infiltration areas may be difficult to identify since definitive karst features are not always obvious. Generally, a lack of natural drainage way erosion or inadequately sized drainage ways (for the size of the contributing area) may be clues to karst loss. Other observations may include undersized drainage conduits that never run full.

Thick sequences of carbonate bedrock (limestone and dolomite) underlie a sizeable area in - central and southeastern Pennsylvania. Folding and faulting have extensively fractured this bedrock. Over millions of years, chemical weathering of the deformed carbonate units by weakly acidic water along points of weakness has produced a subdued, but deeply developed karst (Wilshusen and Kochanov, 1999). The process of carbonate bedrock dissolution results in a distinct landscape called karst topography. Karst topography includes features such as sinkholes, surface depressions, and caves. Other notable characteristics are significant changes in the depth to bedrock or groundwater table within a short distance and “losing” streams that disappear into the subsurface.

Karst development is a water-driven system; whereby the enlargement of fractures creates a natural system of “pipes and drains” that serves to transport groundwater, surface water and surficial material. Karst drains are typically covered with a mantle of soil. Surface and/or groundwater can mobilize these sediments into subsurface voids, resulting in sinkholes or closed depressions. Variations in the volume of water entering the karst system can increase the rate at which sinkholes develop.

Karst aquifers are vulnerable to contamination when the natural filtration capability of soil is bypassed due to thin soils, sinkholes or subsurface open fractures and voids. Contaminants can enter the karst system and travel long distances over a relatively short period of time.

When addressing stormwater management issues, **the complexities of a karst system demand a more rigorous scrutiny than other geologic settings.** In areas that undergo land-use changes, stormwater, which once had established infiltration routes into the ground, may then be captured and redirected into a variety of artificial drainage ways and catchment areas. This change creates an imbalance that can result in increased subsidence and sinkhole activity, potential groundwater contamination, and could affect the quantity and quality of the karst aquifer system (Knight, 1971; Newton, 1987; White and others, 1986).

#### 7.4.2 Infiltration vs. non-infiltration

A decision must be made to either promote infiltration at a karst site (recommended, but may not be feasible in all areas) or eliminate infiltration altogether as an attempt to curb sinkholes or contamination liability. This decision must be based on a sound site assessment and



consideration of potential contaminants that can be introduced by the proposed project. The worst scenario is to ignore karst features entirely and thus significantly increase the potential for costly delays, repairs, catastrophes and legal proceedings.

Stormwater control plans that utilize infiltration in karst are more common in areas such as Kentucky (Crawford, 1989) and Tennessee (McCann & Smoot, 1999) but have generally been avoided by hesitant or inexperienced developers in Pennsylvania. Non-infiltration plans may seem safer and more economical even with the increased cost, but, an additional, long-term “cost” is associated – lowering of the groundwater table, reducing the potential groundwater resources of an area, and increasing the risk of a sudden, catastrophic ground collapse (via a failed impoundment, swale, retention structure, etc.). Use of infiltration BMPs, especially watershed-wide, is the best method for stormwater control in most karst areas. (Crawford, 1989)(McCann & Smoot, 1999) Future research in this area should identify additional innovative solutions to these stormwater management challenges.

### 7.4.3 Basic Principles

Successful stormwater management in karst areas can be achieved by developing a strategy for the site that will be best suited to function within the tolerance limits of the natural system. Every effort should be made to maintain the pre-development hydrologic regime and utilize existing karst drainage features in a safe way. The risk of sinkholes, subsidence problems and potential groundwater contamination issues should be of utmost consideration. As previously noted in Chapter 3, watershed-wide stormwater planning that considers and incorporates the existing karst drainage will achieve the best overall results.

The following basic principles must be considered in karst areas:

#### **Identification, understanding and consideration of geologic information are crucial.**

- An initial site assessment is critical to identify karst and existing drainage features. It is recommended that a broader area be reviewed to spot regional trends in geology and drainage. A thorough site assessment should include, but not be limited to, the following:
  - Review of aerial photographs, geologic literature, sinkhole maps, borings (if available), existing well data, and municipal wellhead or aquifer protection plans.
  - Site reconnaissance, including a thorough field examination for features such as limestone pinnacles, sinkholes, closed depressions, fracture traces, faults, springs and seeps. Special attention should be paid to confirmation of features located during literature review.
  - Drilling of boreholes.
  - Determination of groundwater elevations, especially with respect to the bedrock surface, and flow direction. To assess seasonal changes, it is necessary to obtain groundwater measurements over several months to a year.
  - Geophysical surveys to locate subsurface anomalies. Consult a professional experienced in geophysical methods and karst areas before conducting these tests.
- Observe the site under different weather conditions especially during heavy rain events and through different seasons. Identify and map the natural drainageways.
- A site design in karst areas should be supported by a geotechnical or hydrogeologic report conducted by a qualified and/or licensed professional (i.e., soil scientist, geologist, hydrogeologist, geotechnical engineer, etc.). The report should include:
  - Site reconnaissance discussion.

- Identification and mapping of karst features and hydrogeologic conditions of the site.
- Identification and mapping of existing drainage patterns and features.
- Discussion of groundwater hydrology.
- Survey of soil characteristics and thickness and analysis of the site's capability for infiltrating stormwater.
- A discussion of how infiltration will be handled to avoid contamination of the groundwater aquifer.
- A plan view drawing of the site, noting the locations of important features. This plan should delineate areas available for infiltration, areas not suitable for infiltration and areas where development should not occur.
- A contingency plan to be used if unexpected conditions or unmapped karst features are encountered during site excavation.

Refer to the Case Studies in karst areas contained in Chapter 9 for examples. More information is available from Virginia DCR Technical Bulletin No. 2, Memon and others, 1999 and Ralston, and others, 1999)

#### **Maintain natural conditions within the stormwater plan to the maximum extent possible.**

- Maintain the natural water balance for surface flows and groundwater recharge. (See also section 5.4.3). Existing drainage patterns and features, both natural and artificial, should be taken into consideration. Use these pre-development drainage ways to the maximum extent possible. Avoid building on or adjacent to these drainage features.
- Maintain groundwater levels and hydrostatic pressure to the maximum extent possible – avoid large groundwater withdrawals, elimination of recharge areas or concentrated injection (in reference to time as well as location). Fluctuating groundwater levels will undermine the structural stability of the subsurface.
- Establish a buffer zone around karst features that are not used for infiltration - areas of historic or active sinkholes or surface depressions and related geologic features such as fracture zones and faults - grading water away from these features. Establish filter berms (with gabions or vegetation, for example), etc. to prevent contamination from overland flow and discourage access to these areas. (McCann & Smoot, 1999)
- Designate aquifer recharge areas. Promote safe infiltration. Direct recharge into groundwater aquifers without proper filtration of sediments and pollutants is prohibited. *Improved* sinkholes may be utilized as injection wells, but must be properly constructed. Casing must be firmly seated into competent bedrock and grouted into place. Sediment and pollution controls must be incorporated. EPA categorizes these structures as Class 5 Underground Injection Wells. With adequate planning and design, these infiltration structures can be used successfully in karst areas (McCann & Smoot, 1999, case studies). A permit from EPA must be obtained to construct and operate a Class 5 Underground Injection Well.
- Replicate natural hydrologic loading rates as much as possible when designing infiltration BMPs. Minimize impervious surfaces. Drastically increasing or decreasing the loading rate may promote or accelerate sinkhole development. (Loading rate is the ratio of drainage area to infiltration area.)

#### **Avoid Concentrating Water.**

- Employ methods to reduce runoff volumes and velocity.

- Implement numerous infiltration BMPs throughout the site instead of just one.
- Stormwater should not be conveyed into concentrated runoff flow paths. Broad and shallow flow dispersion is most effective. Minimizing impervious surfaces should aid in decreasing runoff, in general. (Virginia DCR)
- Impounded water causes soil saturation and loss of cohesion, and produces stress from the weight of the water. Differences in hydraulic head and steep hydraulic gradients can result in sinkhole development. For these reasons, shallow basins with overflow channels are preferred over one large, deep basin. Basins, if they must be used, must have synthetic liners to prevent failure and sudden loss of water into a subsurface drain.

#### **Diligence and site maintenance can influence the ultimate success of the stormwater plan.**

- Seal all exploratory boreholes to eliminate surface water entry.
- Minimize earth disturbance when installing stormwater structures. Disturbing the upper, cohesive soils can lead to subsidence and future collapses. (Newton, 1987)
- Management of stormwater structures usually ends after construction. In karst, however, BMPs need to be inspected, cleaned, maintained, and possibly repaired. Sinkholes should be promptly and properly repaired. Inspection and maintenance schedules must be addressed in the plans.
- Pay specific attention to the integrity of piping of all types. Evidence of pipe leakage or sagging should be immediately addressed because these areas quickly become the focus for soil loss into subsurface voids that leads to subsidence and sinkhole collapse.
- All stormwater management designs for karst areas must include details for sinkhole repair during and after construction. The sinkhole repair plan should appear on the construction drawings and also be made a part of the site's Operation and Maintenance Plan. The sinkhole repair plan should be flexible to accommodate a variety of failure modes and locations. A qualified individual should oversee the repair work.

#### **7.4.4 BMP Considerations**

The conventional stormwater BMPs presented for traditional development activities are generally applicable and effective in karst areas. However, these are not necessarily the *most* effective or appropriate. (McCann & Smoot, 1999) (Virginia DCR) The following are some conventional examples of karst area BMPs:

##### **Increased storage**

- Dry detention pond
- Wet retention with lined settling ponds
- Shallow detention ponds
- Vegetated Roof

##### **Increased infiltration**

- Runoff spreaders
- Porous pavement
- Improved sinkholes / Class V injection well (See Crawford, 1989, Chapter 3)
- Perforated pipes
- Bioretention cells / rain gardens

**Decreased velocity**

- Increased vegetation density / vegetated swales
- Terraced slopes
- Rip rap (preferably using carbonate rock)

**Pollution control/water quality**

- Filter berms
- Gravel or sand filtration systems
- Peat moss or activated carbon filtration
- Constructed wetlands (lined)
- Increased vegetation density / rain gardens
- Rip rap
- Compost

**7.5 Mined Lands**

Disturbed lands that have been strip or surface mined, or are underlain by deep mine excavations, are one of the most difficult areas on which to apply stormwater BMPs. The drainage of rainfall that has percolated through residual mine wastes on the land surface, or infiltrated the existing land surface and drained into deep mines and subsequently found its way to the surface from mine tunnels, has produced one of the most severe water quality conditions in Pennsylvania. Thousands of miles of streams within the state are devoid of aquatic life because of the extreme acidity of surface waters that are polluted by abandoned mine discharges. This condition is considered by most experts to be the single greatest pollution issue in the state, simply because it has no obvious or easy solution.

Since this acid drainage from abandoned mines begins as rainfall on the surface, the obvious solution would seem to be to redirect any rainfall away from any surface materials containing mine wastes, and assure that as little infiltration as possible took place above deep mine layers.

The exclusion of all infiltration BMPs in these areas would negate many of the BMPs described in Chapter 6, other than the vegetated roof systems and the capture/reuse measures. One important consideration is that the use of vegetation to remove or change the chemical form of pollutants in acid mine drainage could also include the pollutant load from new impervious surfaces where suitable. A great deal of research has been directed toward the use of wetland systems as passive AMD treatment technologies (PADEP, 2005). These systems form part of a larger strategy for abandoned mine reclamation (PADEP, 1998) in those watersheds where the problem is widespread.

All of this very important water quality research does not address the specific problem created by new development or redevelopment on mined lands. Where the potential exists for runoff from new development to come into contact with mine wastes, then surface drainage design should convey runoff to surface swales and channels free of any mine waste residual. If detention basins are used for rate mitigation, they should be lined if situated on surface mined lands or over deep mines. Water quality measures will need to rely on intensive maintenance programs for new development, and control of pollutant application, especially fertilizers, herbicides and pesticides. If porous pavements are designed, the sub-surface beds must be lined, so that the primary function will be detention rather than volume reduction by infiltration. Finally, the land development plan should place special emphasis on protection of existing vegetation and

restoration of new woodlands, because they offer the best method of healing and restoring these damaged lands.

## 7.6 Stormwater Management Near Water Supply Wells

Pennsylvania ranks third in the nation for the total number of public water supply wells, and nearly half of Pennsylvania's 12 million residents get drinking water directly from ground water sources. It is critical that stormwater BMPs be designed to remove pollutants from stormwater that is to be infiltrated in close proximity to public or private water supply wells, and be sufficiently isolated from ground water supply sources.

Water supply wells in Pennsylvania generally pump water from two types of aquifers, unconsolidated aquifers and consolidated rock or fractured-bedrock aquifers. Unconsolidated aquifers are composed of sands, silts and gravel. They are generally unconfined and close to the surface, have high porosity and a high measure of permeability. Water moves into and through unconsolidated aquifers readily. These aquifers are generally limited to major stream valleys, the Atlantic Coastal Plain and the glaciated northeast and northwest regions of the state. Fractured-bedrock aquifers are the most widespread and commonly exploited aquifers in the state. They may be bedrock layers composed of sandstone, shale, or carbonate rocks such as limestone and dolomite but they can also be layered or irregular bodies of crystalline rocks such as gneiss, schist, granite and diabase. Ground water in bedrock aquifers can occur in either unconfined or confined conditions. Fractured-bedrock aquifers have low primary porosity and ground water is mainly stored in openings between rock layers and in fractures throughout the rock. Water moves into and through these aquifers much more slowly than in unconsolidated aquifers. Exceptions occur in limestone and dolomite where dissolution of the rock increases the size and frequency of the fractures and therefore increases secondary porosity and permeability. Some Pennsylvania public water supply wells in limestone and dolomite aquifers produce larger volumes of water than do wells in unconsolidated aquifers.

### Stormwater infiltration BMPs near water supply wells

Pennsylvania's Safe Drinking Water Regulations (25 Pa. Code § 109) establish a three-tiered approach to wellhead protection of public ground water supplies. Zone I is the innermost protective zone surrounding a well, spring or infiltration gallery that may range from a radius of 100 to 400 feet depending on site-specific source and aquifer characteristics. The water supplier must own this area or substantially control activities within the zone that could potentially harm quality or quantity of the source. Zone II is the capture zone that encompasses the portion of the aquifer through which water is diverted to a well or flows to a spring or infiltration gallery. Zone II is defined as a one-half mile radius around the source unless a more rigorous hydrogeologic delineation is performed. Zone III is the area beyond the capture zone that contributes significant recharge to the aquifer within the capture zone. For more detailed information about protecting underground drinking water supplies, please refer to the Department's Source Water Protection Program.

Infiltration BMPs should not be located within Zone I wellhead protection areas. In addition, extreme caution must be exercised when planning stormwater infiltration BMPs for use in delineated Zone II areas or for use in areas within one half mile of public water supply wells. This is especially important where the water supply wells are in unconsolidated aquifers or bedrock aquifers of fractured limestone or dolomite. These easily recharged aquifers can become

contaminated through stormwater infiltration BMPs unless adequate stormwater pre-treatment occurs first. It is also essential that local government officials be contacted early when planning infiltration BMPs within Zone II wellhead protection areas. Some municipalities have specific ordinances that address land use within rigorously delineated Zone II areas.

To ensure that privately owned wells and ground water sources serving non-community water supply systems are adequately protected, a minimum isolation distance of 50 feet must be observed between the ground water source and all infiltration BMPs.

As always, the basic tenets of stormwater management should be applied:

- All efforts should be taken to minimize the amount of impervious area on the site; and
- Stormwater management should be designed to disperse runoff to a number of BMPs scattered around the site rather than conveying and concentrating runoff to just a few locations.

One of the most effective ways to pre-treat stormwater for infiltration is to pass the stormwater through a layer of compost or a compost/soil mixture before allowing it to infiltrate into the ground. (Compost is meant to be decomposed or composted organic material, not mulch.) EPA and others report that organic materials in the compost and compost/soil mixtures have demonstrated pollutant removal rates of over 90 percent for sediments, metals, bacteria and petroleum hydrocarbons, and as high as 75 percent for total phosphorous. Pollutant removal effectiveness increases with the amount of compost/soil mixture the stormwater has to pass through. Compost or soil/compost mixtures are not effective in removing chlorides such as those found in deicing salt. The post-construction stormwater operation and maintenance plan should include limited use of deicing salts in areas draining to infiltration BMPs. Sand or other inert antiskid materials should be used in parking lots or roadways if stormwater infiltration is being used near water wells to minimize water quality impacts from stormwater/melt water runoff.

Use compost or compost/soil mixtures in vegetated swales, bio-retention areas, and infiltration trenches and basins so that stormwater must first pass through 18 to 36 inches of compost or a compost/soil mixture before percolating into the ground. The type of vegetation planted in the compost or compost/soil layer should be selected, in part, for its ability to replenish organic matter through seasonal leaf fall, root die back etc. It is important to maintain a high percentage of organic material in the soil because it is the organic material (compost) that has the cation exchange capacity necessary to capture pollutants in stormwater.

Porous pavement and other sub-surface stormwater infiltration BMPs are not recommended for use in areas close to water supply wells. These BMPs generally cannot be designed to allow stormwater to percolate through 18 to 36 inches of compost or soil/compost mixture.

### **Non-infiltration BMPs near water supply wells**

Non-infiltration type stormwater BMPs can be used in areas close to water supply wells. As with all stormwater BMPs, they should be planned so that the stormwater runoff is spread throughout a number of locations rather than conveyed and concentrated in just a few places. Stormwater conveyance systems for loading docks, gas stations and other areas that have an increased likelihood of hazardous spills should be designed with an emergency shutoff to contain spills if there is an accident or release.

## Appropriate BMPs

Some appropriate BMPs to consider for stormwater management in areas within one half mile of a water supply well are discussed below. These BMPs are detailed more thoroughly in Chapters 5 and 6.

**Reduce Parking Imperviousness:** Parking areas should be kept to the minimum allowed by the municipality. Excess parking area increases the volume of runoff that must be managed.

**Rooftop Disconnection:** Roof leaders (gutters) in residential and urban areas can be re-configured to drain into Rain Barrels, or flow onto lawn areas. Multiple, smaller stormwater elements placed around the home/structure can be combined to form a flexible design applicable to confined areas. Larger, commercial buildings may have internal drainage systems, which can still be disconnected into larger stormwater elements such as cisterns, planters, vertical storage or infiltration BMPs. Roof runoff can often be routed directly to an infiltration BMP. Roof runoff is generally cleaner than street and parking lot runoff and may not require as much pre-treatment before infiltrating into the soil.

**Vegetated Roof:** A vegetated roof is one of the most effective (both cost and stormwater – wise) methods to manage stormwater in an urban environment. Many buildings in urban areas have large flat roofs that can be converted into vegetated roofs.

**Rain Garden/Bioretenion:** Rain Gardens are excellent applications for use around water supply wells and can be designed to fit areas of various shapes and sizes. Common locations are parking lot islands, landscaped areas around buildings, and plantings adjacent to streets. Runoff can be directed into these areas either by a “bubbler” inlet or by graded surfaces. Curb cuts can be utilized in parking areas and along roads to convey stormwater to these systems. Rain gardens and bio-retention areas should contain 18 to 36 inches of compost or compost/soil mixture. The pollutant removal capability of the BMP increases with the depth of the compost or compost/soil mixture used.

**Infiltration Trench:** Infiltration trenches can pick up runoff from parking areas and roads. A variation of this theme is the planting of trees and other vegetation in the trench along sides of roads, between the road and the sidewalk. This system promotes tree growth and facilitates the evapotranspiration of stormwater through tree and plant uptake. Infiltration trenches must be constructed with a layer of 18 to 36 inches of compost or compost/soil mixture for pollutant removal. The efficiency of the BMP improves with the depth of the compost or compost/soil mixture used.

**Capture & Reuse of Rooftop Runoff:** Rain barrels can be used to capture runoff originally coming from roof leaders. They are small enough to fit in yards and can easily be employed in urban residential neighborhoods. Cisterns and vertical storage units can be placed in corners of structured parking lots, inside buildings, on the outside walls of buildings, in adjacent alleys, alongside elevator shafts, and other locations deemed feasible by the designer. Vertical storage is well suited for use in urban areas where space is at a premium; the shape and location of this BMP requires very little horizontal land area.

**Wet ponds:** Monitored performance of well constructed and maintained wet ponds has documented efficiencies of greater than 90 percent removal for suspended solids, and ranges of 60 – 70 percent removal for nutrients and 60 – 95 percent removal for heavy metals. Wet ponds can also be used to pre-treat stormwater before it is conveyed to infiltration and bio-retention BMPs.

**Vegetated swales:** Vegetated swales are excellent applications to attenuate stormwater volume and provide effective pollutant removal while conveying and dispersing stormwater runoff. The swales should contain 18 to 36 inches of compost or compost/soil mixture to remove pollutants from any stormwater infiltrating through the swale.

**De-icing alternatives:** Sand or other inert antiskid materials should be used in parking lots or roadways in areas near water supply wells or upstream of surface-water intakes to minimize water quality degradation from stormwater or melt water runoff.

## 7.7 Surface Water Supplies and Special Protection Waters

Antidegradation requirements for special protection waters (High Quality and Exceptional Value) and for surface water supply (Potable Water Supply) will be met if the post-construction stormwater infiltration volume equals or exceeds the pre-construction stormwater infiltration volume, and that any post-construction stormwater discharge is pre-treated and managed so that it will not degrade the physical, chemical or biological characteristics of the receiving stream. Please refer to the Department's *Water Quality Antidegradation Implementation Guidance* (document number 391-0300-002) for more information.

The project should be designed to minimize the amount of impervious area. Any resultant stormwater should be infiltrated to the maximum extent possible. Water quality treatment BMPs should be employed for all stormwater that is discharged. Stormwater BMPs should be planned so that the stormwater is spread out to a number of locations rather than conveyed and concentrated in just a few places. Finally, the volume and rate of any stormwater discharge must be managed to prevent the physical degradation of the receiving water, such as scour, and stream bank destabilization.

### Stormwater infiltration near surface water supplies and Special Protection waters

Care must be taken when planning stormwater infiltration BMPs for use in areas within two miles \* on either side of special protection waters or surface waters used for public water supply. Infiltration BMPs in these areas must be designed to encourage maximum pollutant removal before the stormwater is infiltrated into the ground or discharged to a receiving stream.

*\*[Pennsylvania also employs a three-tiered approach - for surface water source protection. **Zone A** is a 1/4 mile buffer on either side of the river or stream extending from the area 1/4 mile downstream of the intake upstream to the five hour time-of-travel (TOT). **Zone B** is a two-mile buffer on either side of the water body extending from the area 1/4 mile downstream of the intake upstream to the 25 hour TOT. **Zone C** constitutes the remainder of the basin. Please refer to the Department's Source Water Protection Program for more information.]*

One of the most effective ways to pre-treat stormwater for infiltration is to pass the stormwater through a layer of compost or a compost/soil mixture before allowing it to infiltrate into the ground. The organic materials in the compost and compost/soil mixtures have repeatedly demonstrated



pollutant removal rates of over 90 percent for sediments, metals, bacteria and petroleum hydrocarbons, and as high as 75 percent for total phosphorous. Pollutant removal effectiveness increases with the amount of compost or compost/soil mixture the stormwater has to pass through. Compost or soil/compost mixtures are not effective in removing chlorides such those found in deicing salt. The operation and maintenance plan for these BMPs should include judicious or limited use of deicing salts in areas draining to the BMP.

Vegetated swales, bio-retention areas, infiltration trenches and basins should be constructed so that stormwater must first pass through 18 to 36 inches of compost or a compost/soil mixture before percolating into the ground. The type of vegetation planted in the compost or compost/soil layer should be selected, in part, for its ability to replenish organic matter through seasonal leaf fall or root die back. Maintaining a high percentage of organic material in the soil is of utmost importance. It is the organic material (compost) that has the cation exchange capacity necessary to capture pollutants in stormwater.

### **What if the stormwater cannot be infiltrated?**

Infiltration is not the only way to reduce stormwater runoff volumes. Vegetated roofs can be used effectively on brownfield sites to retain much of the rainwater that falls on the roof. Stormwater can also be retained in basins or landscaped ponds and allowed to evaporate. Cisterns and vertical storage units can be placed in corners of structured parking lots, inside buildings, on the outside walls of buildings, in adjacent alleys, alongside elevator shafts, and other locations deemed feasible by the designer. Vertical storage is very applicable to urban areas where space is at a premium. The shape and location of this BMP requires very little land area. Water collected this way can be re-used for things such as fire suppression, drip irrigation, lawn sprinkling, cooling buildings, toilet flushing and recreational water. Chapter 6 of this manual provides more detailed information on stormwater capture and reuse.

## **7.8 Urban Areas**

### **7.8.1 Highly Impervious Urban Land**

This land area of special consideration includes the most densely populated regions of the state. The intensity of land development in most urban centers has resulted in a land use pattern that could be considered fully developed, with an almost continuous impervious surface comprised of multi-story structures surrounded by pavement. Beneath these paved areas lay a complex web of; water, wastewater, stormwater, gas, electric, stream and communications infrastructure. In the most densely developed urban communities, people also move beneath the surface in trains and subways. Auto parking is largely provided in concrete boxes or below buildings. The few "green areas" remaining are isolated parks and public spaces, many of which are also underlain with auto parking levels extending 60 feet or more into the ground. Narrow planting strips along many urban corridors support "street trees" that wage a constant battle to survive in a hostile environment.

Beneath these urban landscapes lie the residue of prior development, which in older cities such as Philadelphia can form a rubble layer many feet thick, comprised of bricks, blocks, concrete, wood, and other building materials. All of these conditions severely limit the use of any BMPs that

are dependent on infiltration into the soil mantle for volume reduction, and so the use of other BMPs is necessary.

One of the few “downtown” locations suitable for volume reduction is the roof of building structures. European engineers and architects learned the importance of going “up on the roof” for stormwater management several decades ago, and it has become the primary method in most cities. In Germany local ordinances require the construction of vegetated roof systems on flat or up to 20% sloping roofs. Failure to comply with these rules result in a “stormwater tax” being levied that is sufficiently onerous to virtually assure compliance. This action was precipitated by an increased awareness of the impacts of stormwater on “combined” sewers that convey both runoff and raw sewage to the nearest stream, river or lake. Many of the German cities were reduced to rubble during World War II, and in the rebuilding process it was recognized that vegetated rooftops on all new buildings provided a solution to anticipated urban stormwater problems.

Mandatory application of this BMP in existing urban centers, such as Philadelphia and Pittsburgh, will require specific ordinances that guide both new and existing building efforts, a significant capital program for any municipality. Without the opportunity for infiltration measures, however, the available alternatives to vegetated roof systems are quite limited, and focus on various capture and reuse efforts, most of which would require a significant re-plumbing effort for existing structures.

In terms of appropriate Control Guidance for the urban center, the solution may have to be tailored to fit the hydraulic capacity of the existing conveyance system. Where combined sewers are the only drainage pipes available, the overflow and discharge from CSO outfalls is usually triggered by frequent rainfall events of an inch or less. If the volume of runoff from a 1-inch storm event can be reduced in these areas, many combined sewer overflows can be avoided and much water quality benefits can be gained. Detailed computer modeling can develop the appropriate volume control guidance for highly urban watersheds with single pipe sewers.

As development has extended out from urban centers into surrounding farmlands, the percentage of impervious surfaces within a given land parcel has generally been regulated with the assumption that less impervious cover (combined with height limitations) would result in a community that did not have the negative aspects of the more dense urban environment. This has proven not to be the case, especially for stormwater. The suburban commercial center or office park can result in a highly impervious land parcel, equal to or greater than some older communities, even though it exists on an isolated parcel. Suburban residential developments are generally comprised of far less impervious cover than the urban streets, but still produce a significant pollutant load (Bannerman et al., 1993). This suburban runoff is generated in large measure from land that has been altered and then re-vegetated. The construction process has compacted the soils in these grassed and landscaped areas such that runoff volume has increased significantly. Thus a low-density suburban residential lot could degrade water quality as severely as the row home in center city Philadelphia.

### **7.8.2 Urban Water Quality**

Several studies (Schueler, 2003) have indicated that the amount of impervious cover in a watershed is a good indicator of degraded water quality. The impacts of urbanization on a watershed can be measured when the level of impervious cover reaches 5 percent. Water quality in the watershed is severely degraded by the time the level of impervious cover reaches 20 percent. This reduction of water quality and stream habitat occurs from the increased runoff

volumes eroding stream banks, pollutants conveyed with this runoff, and diminished stream base flow. The pattern of degradation for urban streams shows a dramatic increase in magnitude and intensity of runoff with a corresponding reduction in stream flow during much of the year, and drought periods resulting in a transition from perennial to intermittent hydrology. In older urban centers, where the impervious cover can reach 75% or more, the hydrologic cycle has been so severely altered that full restoration seems to be impossible, especially in terms of restoring any original stream networks that function as combined sewers beneath the city streets.

Physical pollutants of frequent concern in urban areas include suspended solids, bacteria, phosphorus, nitrate, hydrocarbons, and metals. The runoff from streets is a significant source of pollutants and concern in urban areas (Barrett, et al, 1995) and is the single greatest source of water quality pollutants in the urban environment. In general, rooftop runoff is an order of magnitude less in concentration for most pollutants, and only becomes a problem when it is added to the surface flows, transporting the pollutant load accumulated on pavements. Such street runoff is affected by hydrocarbon emissions including leaks from vehicles, nutrients and organics from urban vegetation, bacteria and other pollutants from pet and other animal waste, and the general mix of wastes discarded in urban environments. Street curb and gutter systems are traditionally designed to convey, not trap, the fine particles associated with street runoff, and will carry the litter and debris directly to surface inlets, the storm sewer system and finally the receiving streams.

Increased temperature is a significant water quality issue in urban areas that can quickly pollute receiving waters. Although interception or disconnection of stormwater flows (i.e., peak shaving) to pervious areas may provide some limited reduction in temperature impact, opportunities for disconnection are often limited. It should be noted that low dissolved oxygen levels in receiving streams are related to the extreme temperature variability of runoff from impervious areas (as temperature increases, dissolved oxygen levels decline with lethal consequences to aquatic life). For fish and aquatic insects, temperature ultimately can be one of the most critical pollutants, presenting especially difficult challenges in urban areas.

Many urban storm sewers are in fact buried streams, especially first and second-order streams that were enclosed and buried as the urban center expanded in the late 19<sup>th</sup> century. These buried streams still serve as storm runoff conduits with the natural movement of groundwater along and into the stream channel. In some areas, the fill material above the original channel may eventually wash away, creating subsidence problems and “cave-ins” in urban streets. In other areas, the pipes serve to convey water more rapidly than the original stream would have done, creating downstream flooding or surcharging of both the sub-surface culverts and surface outlets. Deprived of both oxygen and sunlight, the original rate and water quality buffering function of first and second-order streams has been lost.

One aggressive concept that has received considerable attention but little real implementation is the idea of “daylighting” buried streams. This means that the original riparian channel is uncovered and restored with new stream banks cut and revegetated as appropriate. While representing a dramatic measure to restore an urban stream, the reality of fill removal and possible loss of property values along the original channel alignment usually translates into an unacceptable economic impact and disruption in the urban landscape. Even where substantial redevelopment has occurred in older cities, little serious thought has been given to the restoration of buried streams.

High levels of trash and debris, including concentrated areas of pet waste, characterize many urban streets. A high degree of imperviousness, combined with a curb and gutter system

designed to flush and convey debris, makes the urban landscape a significant source of pollutants that are rapidly conveyed to receiving surface streams. The use of various devices to intercept and contain these waste materials offers some measure of pollutant reduction, if maintenance is performed on a regular basis. Street cleaning by vacuum units also presents a very efficient method of pollutant removal, but purchase cost combined with operation and maintenance makes this BMP a significant investment for any urban community. In one urban center (Santa Monica, CA), the street gutters have been formed with porous concrete and infiltrating underdrains, combined with traps at corner inlets. Less dense residential portions of the urban community may utilize a variation of this approach, where shallow infiltration can be accomplished.

Stormwater “hot spots” such as gas stations, industrial areas, vehicle service areas, and public works storage areas are commonly found in urban communities, especially in the industrial zones. Smaller facilities, such as fueling islands and dumpster pads, should be treated as separate sources of pollution, and the runoff should be prevented or segregated from surface runoff. On the larger scale, a block-by-block strategy may be appropriate in portions of the community where pollutant-producing activities are concentrated.

### 7.8.3 Other Urban Stormwater Management Considerations

In many urban areas, local codes and regulations may require designs that are contrary to current BMP design. For example, local codes may require that all roof leaders be connected directly to a storm sewer, or that all streets have curbs and gutters. Local code officials may not be familiar with on-going stormwater management efforts. In these instances, early review of local requirements and communication to the appropriate officials is necessary to avoid BMP construction delays or denials. Long-term, review and updating of local ordinances may be warranted, with model urban guidelines developed by PADEP.

Redevelopment in depressed or blighted communities adds an additional dimension to stormwater management. These conditions have led some states (such as New Jersey) to exclude such communities from new stormwater regulations. The imposition of stringent regulations that are not feasible may serve to direct redevelopment to undeveloped sites outside the urban center. Brownfield parcels with significant residual contamination must be designed carefully to assure that any residual pollutants are not mobilized by stormwater BMPs. Highly contaminated sites may warrant excavation and removal of materials before any BMP can be installed. Stormwater management must not be detrimental to the economic health of urban areas, because this would ultimately be more damaging to the overall water resources of an area.

Most of the BMPs described in Chapter 6 can find some application in the urban environment, but a number of seemingly small measures, not described in separate BMP sections, can have a cumulative effect if applied to hundreds or thousands of individual residences or small buildings. These types of measures include:

**Reduce Parking Imperviousness** - New parking lots in urban areas can follow the guidelines set out in Chapter 5 relating to reducing imperviousness, while rehabilitation of existing parking lots can be designed with some areas of pervious paving, or even re-vegetated areas if the parking spaces are under-utilized.

**Rooftop Downspout Disconnection** - Roof leaders (gutters) in residential, urban areas can be re-configured to drain into rain barrels or planter boxes, for example. Multiple, smaller stormwater elements placed around the home/structure can be combined to form a flexible design applicable

to confined areas. Larger, commercial buildings may have internal drainage systems, which can still be disconnected into larger stormwater elements such as cisterns, planters, or vertical storage.

**Disconnect from storm sewers** - Disconnecting from existing storm sewers can be accomplished by either adding another inlet slightly up-gradient from the existing inlet to intercept the runoff and redirect it into a storm water feature, or closing off the existing inlet and regrading the area to drain into a stormwater feature, such as an infiltration bed.

**Street Sweeping** - Streets, roads, and highways constitute large percentages of urban areas, and pollutant loadings are usually greatest from these areas. Runoff from streets may end up at a treatment plant, but is more typically discharged directly to a body of water. Actively sweeping or vacuuming these surfaces can greatly reduce the amount of pollutants entering inlets, and possibly reduce the need for other (usually more costly) water quality measures.

**Rooftop Runoff Capture & Reuse** Rain barrels can be used to capture runoff originally coming from roof leaders, and they are small enough to fit in yards often found in urban residential neighborhoods. Cisterns and vertical storage units can be placed in corners of structured parking lots, inside buildings, on the outside walls of buildings, in adjacent alleys, alongside elevator shafts, and other locations deemed feasible by the designer. Vertical storage is very applicable in urban areas where space is at a premium; the shape and location of this BMP requires very little horizontal land area.

**Vegetated Roof:** A vegetated roof is one of the most effective (both cost and stormwater – wise) methods to manage stormwater in an urban environment. Many buildings in urban areas have large flat roofs that can be converted into vegetated roofs

**Water Quality Filter** - Filters can be used at the end of a drainage area, or at a “hot spot” to treat pollutant filled runoff. They have urban area relevance because of their size – filters can provide substantial water quality treatment in a relatively small container. They are typically used at the end of a drainage area (before it discharges into a body of water) that did not have room up gradient for other water quality measures.

**Water Quality Insert** - These manufactured devices can be placed in urban area inlets to address water quality. They’re appropriate where stormwater is discharged without other treatment and where removing pollutants before they enter the conveyance system is crucial. They are not appropriate for areas with combined sewers

**Use of Parking lots and rooftops, as special detention areas** - Detaining runoff on impervious surfaces does not have any volume benefit, but does reduce CSO impacts by temporarily holding the runoff and slowly releasing it so that the treatment plant can properly treat it. Surface storage can also help reduce the peak rates of a drainage area by increasing the time of concentration for that specific area. This can be useful in areas that require peak rate reductions, or are subject to downstream flooding.

## 7.9 References

AASHTO Highway Subcommittee on Design Task Force for Environmental Design, 1991. *A Guide for Transportation Landscape and Environmental Design*. American Association of State Highway and Transportation Officials. Washington, D.C.

- Backstrom M. 2000. "Ground Temperature in Porous Pavement during Freezing and Thawing." *Journal of Transportation Engineering – ASCE* 126(5) (September –October): 375-381.
- Bannerman, R.; D. Owens; R. Dodds and N. Hornewer. 1993. "Sources of Pollutants in Wisconsin Stormwater." *Water Science and Technology*. 28(3-5): 241-259
- Barrett, M.E. et al., 1995. *An Evaluation of the Use and Effectiveness of Temporary Sediment Controls, CRWR Online Report 95-6*. Center for Research in Water Resources, Bureau of Engineering Research, The University of Texas at Austin, TX
- Barrett, et al, *Water Quality and Quantity Impacts of Highway Construction and Operation: Summary and Conclusions*, Center for Research in Water Resources, Bureau of Engineering Research, The University of Texas at Austin, Austin, Texas, November 1995
- Blankenship, K., 1998. "Better maintenance of dirt roads will pave the way to cleaner streams." *Bay Journal, Alliance for the Chesapeake Bay*, 8(9)
- Covington III, M.B. *Ditchline Sand Filter Design (Roadway Stormwater Management)*. Carroll County, MD
- Crawford, N.C., 1989. *The Karst Landscape of Warren County*, Technical Report for the City County Planning Commission of Warren County (KY).
- FHWA, 1999. "Is Highway Runoff a Serious Problem?" Federal Highway Administration Environmental Technology Brief, U.S. Department of Transportation, Office of Infrastructure R&D, McLean, VA
- FHWA, 1999. *Stormwater Best Management Practices in an Ultra-Urban Setting: Selection and Monitoring*. Federal Highway Administration, U.S. Department of Transportation.
- Fujita, S., 1997. *Measures to Promote Stormwater Infiltration*. *Water Science and Technology* 36(8-9):289-293.
- Forman, R.T.T., D. Sperling, et al., 2003. *Road Ecology: Science and Solutions*. Washington, D.C.
- Galli, F. 1990. *Thermal Impacts Associated with Urbanization and Stormwater Best Management Practices*. *Metropolitan Council of Governments*. Prepared for: Maryland Department of the Environment. Baltimore, MD.
- Hogland, W. and Wahlman T., (1990). *The Unit Superstructure – Effects on Hydrology and Road Construction*. Report R90:1990, Swedish Council for Building Research. ISBN 91-540-5264-5.
- Hughes, R. E., 2005. Personal Communication, to D. Stum, PADEP, March 15, 2005.
- Knight, F.J., 1971, "Geologic problems of urban growth in limestone terrains of Pennsylvania", *Association of Engineering Geologists Bulletin*, v.8, no. 1, p. 91-101.

Kochanov, William E., 1999. *Sinkholes in Pennsylvania*, Pennsylvania Geological Survey, 4<sup>th</sup> ser., Educational Series 11.

Kochanov, W.E., 1995a, Storm-water management and sinkhole occurrence in the Palmyra area, Lebanon County, Pennsylvania: in Beck, B.F. (ed.), *Karst Geohazards, Engineering and Environmental Problems in Karst Terrane*, Proceedings, 5th Multidisciplinary Conference on Sinkholes and the Engineering and Environmental Impacts of Karst, Gatlinburg, TN, April 2-5, 1995, A.A. Balkema, Rotterdam, p. 285-290.

Legret, M. & Colandini, V. 1999, 'Effects of a porous pavement with reservoir structure on runoff water: water quality and fate of heavy metals', *Water Science and Technology*, vol. 39, no. 2, 111-117.

McCann, Molly S., and James L. Smoot, 1999. "A Review of Stormwater Best Management Practices for Karst Areas", In *Hydrogeology and Engineering Geology of Sinkholes and Karst*, Beck, Pettit & Herring (eds.), Balkema, Rotterdam.pp. 395-398.

Memon, Bashir A., et al., 1999. "Site Selection and Design Considerations for Construction in Karst Terrain / Sinkhole-Prone Area", In *Hydrogeology and Engineering Geology of Sinkholes and Karst*, Beck, Pettit & Herring (eds.), Balkema, Rotterdam. pp. 107-110.

Natural Resources Defense Council, 1999. *End of the Road: The Adverse Ecological Impacts of Roads and Logging: A Compilation of Independently Reviewed Research*.

Newton, J.G., 1987. *Development of Sinkholes Resulting From Man's Activities in the Eastern United States*, U.S. Geological Survey Circular 968.

Oberts, G. 1997. *Lake McCarrons Wetland Treatment System – Phase III Study Report*. Metropolitan Council Environmental Services. St. Paul, MN.

PADEP, 1998. Pennsylvania's Comprehensive Plan for Abandoned Mine Reclamation, Bureau of Abandoned Mine Reclamation, PADEP, June, 1998.

PADEP, 1999. A Model Plan for Watershed Restoration, by PADEP, USACOE, NRCS, OSM, PADCNR, Jan., 1999.

PADEP, 2005. The Science of Acid Mine Drainage and Passive Treatment, PADEP, Bureau of Abandoned Mine Reclamation.

Penn State Center for Dirt and Gravel Road Studies. <[www.dirtandgravelroads.org/](http://www.dirtandgravelroads.org/)>

PennDOT. "Dirt and Gravel Road Program." Pennsylvania Department of Transportation. <http://www.dot.state.pa.us/penndot/bureaus/bms.nsf/infoDirtGravel?OpenForm>

PennDOT, 2004. *Guidelines for Design of Erosion, Sediment, and Stormwater Controls DRAFT*. Pennsylvania Department of Transportation, Bureau of Design.

PennDOT, 2004. *Specifications and Standards for Roadway Construction 70M Series DRAFT*. Pennsylvania Department of Transportation, Bureau of Design.

- Pitt, R., 2001. "Stormwater Management for Highway Projects." Presented at: Symposium on the Pollution of Water Sources from Road Run-Off, Tel Aviv University, Israel.
- Pluhowski, E.J. 1970. *Urbanization and its Effects on the Temperature of the Streams in Long Island, New York*. U.S. Geological Survey, Professional Paper 627-D. U.S. Geological Survey, Washington, D.C.
- Ralston, Mark R. and I.S. Oweis, "Geotechnical Engineering Considerations for Stormwater Management in Karst Terrain", From 1999 Southeastern Pennsylvania Stormwater Management Symposium – Implementing Best Management Practices. October 20-21, 1999, Villanova University.
- Schueler, T. 1995. Nitrate leaching potential from lawns and turfgrass. Raleigh. Tech. Note 56. *Watershed Protection Technol.* 2:276–278.
- Sowers, George F., 1996. *Building on Sinkholes: Design and Construction of Foundations in Karst Terrain*. ASCE Press.
- SWRCB, 2002. *Surface Water Ambient Monitoring Program*. State Water Resources Control Board, North Coast Regional Board, California Environmental Protection Agency.
- Virginia Department of Conservation and Recreation (DCR). *Hydrologic Modeling and Design in Karst*, Virginia DCR Technical Bulletin No. 2. Available at <http://www.dcr.virginia.gov/sw/docs/swm/tecbtln2.PDF>.
- Walker, H., 2002. "Here's the dirt on rural roads: low-tech solutions often are best for assuring your country road or driveway's long, healthy life – homesteading." *Mother Earth News*.
- Walsh, P.M. et al., 1997. *Use of Vegetative Controls for Treatment of Highway Runoff, CRWR Online Report 97-5*. Center for Research in Water Resources, Bureau of Engineering Research, The University of Texas at Austin, TX
- White, E.L., Aron, G., and White, W.B., 1986, "The influence of urbanization on sinkhole development in central Pennsylvania", *Environmental Geology and Water Sciences*, v. 8, no. 1&2, p. 91-97.
- White, W.B., 1988, *Geomorphology and Hydrology of Karst Terrains*. Oxford University Press, New York, 464 p.
- Wilshusen, J.P. and Kochanov, W.E., 1999, "Land Subsidence: Carbonate Terrane" in Shultz, C.H., ed., *The Geology of Pennsylvania*, Pittsburgh Geological Society and Pennsylvania Geological Survey, Chapter 49, Part A, p. 714-723.
- Young et. al., 1996. *Evaluation and Management of Highway Runoff Water Quality (Water Quality Synthesis)*.





---

# **Pennsylvania Stormwater Best Management Practices Manual**

---

## **Chapter 8**

### **Stormwater Calculations and Methodology**





## Chapter 8 Stormwater Calculations and Methodology

- 8.1 Introduction to Stormwater Methodologies.....1
- 8.2 Existing Methodologies for Runoff Volume Calculations and their Limitations.....1
  - 8.2.1 Runoff Curve Number Method.....1
  - 8.2.2 Small Storm Hydrology Method.....2
  - 8.2.3 Infiltration Models for Runoff Calculations.....3
- 8.3 Existing Methodologies for Peak Rate/Hydrograph Estimations and their Limitations.....3
  - 8.3.1 The Rational Method.....3
  - 8.3.2 SCS (NRCS) Unit Hydrograph Method.....4
- 8.4 Computer Models.....4
  - 8.4.1 HEC Hydrologic Modeling System (HEC-HMS).....4
  - 8.4.2 SCS/NRCS Models (WIN TR-20 and WIN TR-55).....5
  - 8.4.3 NRCS NEH 650 Engineering Field Handbook, Chapter 2 (EFH2) .....5
  - 8.4.4 Storm Water Management Model (SWMM).....5
- 8.5 Precipitation Data for Stormwater Calculations.....6
- 8.6 Stormwater Quality Management.....7
  - 8.6.1 Analysis of Water Quality Impacts from Developed Land.....8
  - 8.6.2 Analysis of Water Quality Benefits from BMPs.....10
  - 8.6.3 Water Quality Analysis.....12
- 8.7 Guidance for Stormwater Calculations for Volume Control Guideline 1 and Volume Control Guideline 2.....13
  - 8.7.1 Stormwater Calculation Process.....14
    - 8.7.1.1 For Volume Control Guideline 1 (Flowchart B).....14
    - 8.7.1.2 For Volume Control Guideline 2 (Flowchart C).....15
  - 8.7.2 Water Quality Calculations (Flowchart D).....16
- 8.8 Non-structural BMP Credits.....17
- 8.9 References and Additional Sources.....45



## 8.1 Introduction to Stormwater Methodologies

There have been many methodologies developed to estimate the total runoff volume, the peak rate of runoff, and the runoff hydrograph from land surfaces under a variety of conditions. This chapter describes some of the methods that are most widely used in Pennsylvania and throughout the country. It is certainly not a complete list of procedures nor is it intended to discourage the use of new and better methods as they become available.

There is a wide variety of both public and private domain computer models available for performing stormwater calculations. The computer models use one or more calculation methodologies to estimate runoff characteristics. The procedures most commonly used in computer models are the same ones discussed below.

To facilitate a consistent and organized presentation of information throughout the state, assist design engineers in meeting the recommended control guidelines, and help reviewers analyze project data; a series of Worksheets is provided in this Chapter for design professionals to complete and submit with their development applications.

## 8.2 Existing Methodologies for Runoff Volume Calculations and their Limitations

### 8.2.1 Runoff Curve Number Method

The runoff curve number method, developed by the Soil Conservation Service (now the Natural Resources Conservation Service), is perhaps the most commonly used tool for estimating runoff volumes. In this method, runoff is calculated based on precipitation, curve number, watershed storage, and initial abstraction. When rainfall is greater than the initial abstraction, runoff is given by (NRCS, 1986):

$$Q = \frac{(P - I_a)^2}{(P - I_a) + S}$$

where: Q = runoff (in.)  
 P = rainfall (in.)  
 $I_a$  = initial abstraction (in.)  
 S = potential maximum retention after runoff begins (in.)

Initial abstraction ( $I_a$ ) includes all losses before the start of surface runoff: depression storage, interception, evaporation, and infiltration.  $I_a$  can be highly variable but NRCS has found that it can be empirically approximated by:

$$I_a = 0.2S$$

Therefore, the runoff equation becomes:

$$Q = \frac{(P - 0.2S)^2}{(P + 0.8S)}$$

Finally,  $S$  is a function of the watershed soil and cover conditions as represented by the runoff curve number (CN):

$$S = \frac{1000}{CN} - 10$$

Therefore, runoff can be calculated using only the curve number and rainfall. Curve numbers are determined by land cover type, hydrologic condition, antecedent moisture condition (AMC), and hydrologic soil group (HSG). Curve numbers for various land covers based on an average AMC for annual floods and  $I_a = 0.2S$  can be found in *Urban Hydrology for Small Watersheds* (Soil Conservation Service, 1986) and various other references.

Often a single, area-weighted curve number is used to represent a watershed consisting of sub-areas with different curve numbers. While this approach is acceptable if the curve numbers are similar, if the difference in curve numbers is more than 5 the use of a weighted curve number significantly reduces the estimated amount of runoff from the watershed. This is especially problematic with pervious/impervious combinations: “combination of impervious areas with pervious areas can imply a significant initial loss that may not take place.” (Soil Conservation Service, 1986) Therefore, the runoff from different sub-areas should be calculated separately and then combined or weighted appropriately. At a minimum, runoff from pervious and directly connected impervious areas should be estimated separately for storms less than approximately 4 inches. (NJDEP, 2004)

The curve number method is less accurate for storms that generate less than 0.5 inches of runoff and the Soil Conservation Service (1986) recommends using another procedure as a check for these situations. For example, the storm depth that results in 0.5 inches of runoff varies according to the CN; for impervious areas (CN of 98) it is a 0.7-inch storm, for “Open space” in good condition on C soils (CN of 74) it is 2.3 inches, for Woods in good condition on B soils (CN of 55) it is over 3.9 inches. An alternate method for calculating runoff from small storms is described below.

### 8.2.2 Small Storm Hydrology Method (SSHM)

The Small Storm Hydrology Method was developed to estimate the runoff volume from urban and suburban land uses for relatively small storm events. Other common procedures, such as the runoff curve number method, are less accurate for small storms as described previously. The CN methodology can significantly underestimate the runoff generated from smaller storm events. (Claytor and Schueler, 1996 and Pitt, 2003) The SSHM is a straightforward procedure in which runoff is calculated using volumetric runoff coefficients. The runoff coefficients,  $R_v$ , are based on extensive field research from the Midwest, the Southeastern U.S., and Ontario, Canada over a wide range of land uses and storm events. The coefficients have also been tested and verified for numerous other U.S. locations. Runoff coefficients for individual land uses generally vary with the rainfall amount – larger storms have higher coefficients. **Table 8.1** below lists SSHM runoff coefficients for seven land use scenarios for the 0.5 and 1.5 inch storms.

Table 8.1. Runoff Coefficients for the Small Storm Hydrology Method (adapted from Pitt, 2003)

Rainfall (in.)	Volumetric Runoff Coefficients, $R_v$						
	Impervious Areas				Pervious Areas		
	Flat Roofs/ Large Unpaved Parking Areas	Pitched Roofs	Large Imperv. Areas	Small Imperv. Areas and Uncurbed Roads	Sandy Soils (HSG A)	Silty Soils (HSG B)	Clayey Soils (HSG C & D)
0.5	0.75	0.94	0.97	0.62	0.02	0.09	0.17
1.5	0.88	0.99	0.99	0.77	0.05	0.15	0.24

Runoff is simply calculated by multiplying the rainfall amount by the appropriate runoff coefficient. Because the runoff relationship is linear for a given storm (unlike the curve number method), a single weighted runoff coefficient can be used for an area consisting of multiple land uses. Therefore, runoff is given by:

$$Q = P \times R_v$$

where: Q = runoff (in.)  
 P = rainfall (in.)  
 $R_v$  = area-weighted runoff coefficient

### 8.2.3 Infiltration Models for Runoff Calculations

Several computer packages offer the choice of using soil infiltration models as the basis of runoff volume and rate calculations. Horton developed perhaps the best-known infiltration equation – an empirical model that predicts an exponential decay in the infiltration capacity of soil towards an equilibrium value as a storm progresses over time. (Horton, 1940) Green-Ampt (1911) derived another equation describing infiltration based on physical soil parameters. As the original model applied only to infiltration after surface saturation, Mein and Larson (1973) expanded it to predict the infiltration that occurs up until saturation. (James et al., 2003) These infiltration models estimate the amount of precipitation excess occurring over time – excess must be transformed to runoff with other procedures to predict runoff volumes and hydrographs.

## 8.3 Existing Methodologies for Peak Rate/Hydrograph Estimations and their Limitations

### 8.3.1 The Rational Method

The Rational Method has been used for over 100 years to estimate peak runoff rates from relatively small, highly developed drainage areas (generally less than 200 acre drainage area). The peak runoff rate from a given drainage area is given by:

$$Q_y = C \times I \times A$$

where:  $Q_y$  = peak runoff rate (cubic feet per second)



- C = the runoff coefficient of the area (assumed to dimensionless)  
I = the average rainfall intensity (in./hr) for a storm with a duration equal to the time of concentration of the area  
A = the size of the drainage area (acres)

The runoff coefficient is usually assumed to be dimensionless because one acre-inch per hour is very close to one cubic foot per second (1 ac-in./hr = 1.008 cfs). Although it is a simple and straightforward method, estimating both the time of concentration and the runoff coefficient introduce considerable uncertainty in the calculated peak runoff rate. In addition, the method was developed for relatively frequent events so the peak rate as calculated above should be increased for more extreme events. (Viessman and Lewis, 2003) Because of these and other serious deficiencies, the Rational Method should be used only to predict the peak runoff rate for very small, highly impervious areas. (Linsley et. al, 1992)

The Rational Method, discussed in detail above, has been adapted to include estimations of runoff hydrographs and volumes through the Modified Rational Method. Due to the limitations of the Rational Method itself (see above) as well as assumptions in the Modified Rational Method about the total storm duration, this method should not be used to calculate water quality, infiltration, or capture volumes.

### 8.3.2 SCS (NRCS) Unit Hydrograph Method

In combination with the curve number method for calculating runoff depth, the National Resource Soil Conservation Service (NRCS) also developed a system to estimate peak runoff rates and runoff hydrographs using a dimensionless unit hydrograph derived from many natural unit hydrographs from diverse watersheds throughout the country (NRCS Chapter 16, 1972). As discussed below, the NRCS methodologies are available in several public domain computer models including TR-55 (WinTR-55) computer model (2003), Technical Release 20 (TR-20); Computer Program for Project Formulation Hydrology (1992), and in addition, the U.S. Army Corp of Engineers' Hydrologic Modeling System (HEC-HMS, 2003), EFH2 and the U.S. EPA's Storm Water Management Model (SWMM 5.0.003, 2004).

## 8.4 Computer Models

### 8.4.1 HEC Hydrologic Modeling System (HEC-HMS)

The U.S. Army Corp of Engineers' Hydrologic Modeling System (HEC-HMS, 2003) supersedes HEC-1 as "next-generation" rainfall-runoff simulation software. According to the Corp, HEC-HMS "is a significant advancement over HEC-1 in terms of both computer science and hydrologic engineering." (U.S. ACE, 2001) HEC-HMS was designed for use in a "wide range of geographic areas for solving the widest possible range of problems." The model incorporates several options for simulating precipitation excess (runoff curve number, Green & Ampt, etc.), transforming precipitation excess to runoff (NRCS unit hydrograph, kinematic wave, etc.), and routing runoff (continuity, lag, Muskingum-Cunge, modified Puls, kinematic wave). HEC-HMS Version 2.2.2 (May 28, 2003) can be downloaded at no cost from:

<http://www.hec.usace.army.mil/software/hec-hms/hechms-hechms.html>.

### 8.4.2 SCS/NRCS Models (WIN TR-20 and WIN TR-55)

“Technical Release No. 20: Computer Program for Project Formulation Hydrology (TR-20) is a physically based watershed scale runoff event model” that “computes direct runoff and develops hydrographs resulting from any synthetic or natural rainstorm.” (NRCS, 2004) Hydrographs can then be routed through stream/channel reaches and reservoirs. TR-20 applies the methodologies found in the Hydrology section of the National Engineering Handbook (NRCS, 1969-2001), specifically the runoff curve number method and the dimensionless unit hydrograph. (NRCS, 1992) Version 2.04 was released in 1992 and can be downloaded at: <http://www.wcc.nrcs.usda.gov/hydro/hydro-tools-models.html>. A Beta test version for Windows, WinTR-20, was also released in 2004.

Technical Release 55 (TR-55) was originally published in 1975 as a simple procedure to estimate runoff volume, peak rate, hydrographs, and storage volumes required for peak rate control. (NRCS, 2002) TR-55 was released as a computer program in 1986 and work began on a modernized Windows version in 1998. WinTR-55 generates hydrographs from urban and agricultural areas and routes them downstream through channels and/or reservoirs. WinTR-55 uses the TR-20 model for all of its hydrograph procedures. (NRCS, 2002) WinTR-55 Version 1 was officially released in 2002 and can be downloaded at: <http://www.wcc.nrcs.usda.gov/hydro/hydro-tools-models.html>.

### 8.4.3 NRCS NEH 650 Engineering Field Handbook, Chapter 2 (EFH2)

Peak discharge is determined by procedures contained in NRCS NEH 650 Engineering Field Handbook, Chapter 2. Information needed to use this procedure include watershed characteristics (drainage area, curve number, watershed length, watershed slope) and rainfall amount and distribution.

The method applies when the:

- watershed is accurately represented by a single curve number between 40 and 98
- watershed area is between 1 and 2000 acres
- watershed hydraulic length is between 200 and 26000 feet
- average watershed slope is between 0.5 and 64 percent
- watershed requires no valley or reservoir routing
- urban land use within the watershed does not exceed 10%.

EFH2 Version 1.1.0 was released in March 2003 and can be downloaded at:

<http://www.wcc.nrcs.usda.gov/hydro/hydro-tools-models.html>

Refer to NRCS Engineering Field Handbook, Chapter 2 for a complete discussion of the methodology and its limitations.

### 8.4.4 Storm Water Management Model (SWMM)

The U.S. Environmental Protection Agency (2004) describes its model as:

“a dynamic rainfall-runoff simulation model used for single event or long-term (continuous) simulation of runoff quantity and quality from primarily urban areas. The runoff component of SWMM operates on a collection of subcatchment areas that receive precipitation and generate

runoff and pollutant loads. The routing portion of SWMM transports this runoff through a system of pipes, channels, storage/treatment devices, pumps, and regulators.

SWMM was first developed in 1971 and has since undergone several major upgrades. It continues to be widely used throughout the world for planning, analysis and design related to storm water runoff, combined sewers, sanitary sewers, and other drainage systems in urban areas, with many applications in non-urban areas as well. The current edition, Version 5, is a complete re-write of the previous release. Running under Windows, SWMM 5 provides an integrated environment for editing study area input data, running hydrologic, hydraulic and water quality simulations, and viewing the results in a variety of formats.

SWMM is a powerful model capable of simulating areas consisting of a single, uniform subcatchment to the drainage system of an entire city. Although typically not used to evaluate a single development site, the recently released Version 5 is more user-friendly and should promote an increase in use among design professionals.

Rainfall excess is calculated in SWMM by subtracting infiltration (based on Horton or Green & Ampt) and/or evaporation from precipitation. Rainfall excess is converted to runoff by coupling Manning's equation with the continuity equation. (Rossman, 2004 and James et al., 2003) The newest version of SWMM also incorporates the runoff curve number method for estimating infiltration. (Rossman, 2004)

## **8.5 Precipitation Data for Stormwater Calculations**

In 2004 the National Weather Service's Hydrometeorological Design Studies Center published updated precipitation estimates for much of the United States, including Pennsylvania. NOAA Atlas 14 supercedes previous precipitation estimates such as Technical Memorandum NWS Hydro 35 and Technical Papers 40 and 49 (TP-40 and TP-49) because the updates are based on more recent and expanded data, current statistical techniques, and enhanced spatial interpolation and mapping procedures. (Bonnin et al., 2003 and NWS, 2004) The "Precipitation-Frequency Atlas of the United States," NOAA Atlas 14, provides estimates of 2-year through 1000-year storm events for durations ranging from 5 minutes to 60 days as shown for Harrisburg in Table 8-2 (available online at <http://hdsc.nws.noaa.gov/hdsc/pfds/>). Users can select precipitation estimates for Pennsylvania from over 300 observation sites, by entering latitude/longitude coordinates, or by clicking on an interactive map on the Precipitation Frequency Data Server. These new rainfall estimates are recommended for all applicable stormwater calculations.

**Table 8.2** Harrisburg precipitation estimates.

Precipitation Frequency Estimates (inches)																		
ARI* (years)	5 min	10 min	15 min	30 Min	60 min	120 min	3 hr	6 hr	12 hr	24 hr	48 hr	4 day	7 day	10 day	20 day	30 day	45 day	60 day
2	0.4	0.6	0.8	1.1	1.3	1.5	1.7	2.1	2.5	2.9	3.4	3.78	4.42	5.07	6.83	8.42	10.6	12.6
5	0.5	0.7	0.9	1.3	1.7	1.9	2.1	2.6	3.18	3.68	4.3	4.77	5.51	6.26	8.18	9.9	12.2	14.4
10	0.5	0.8	1	1.5	1.9	2.3	2.5	3.1	3.76	4.37	5	5.63	6.46	7.26	9.28	11.1	13.5	15.8
25	0.6	0.9	1.1	1.7	2.2	2.7	3	3.7	4.64	5.44	6.2	6.93	7.89	8.75	10.9	12.8	15.3	17.8
50	0.6	1	1.2	1.8	2.5	3.1	3.4	4.3	5.42	6.41	7.3	8.09	9.16	10	12.2	14.2	16.7	19.2
100	0.7	1	1.3	2	2.7	3.6	3.9	4.9	6.29	7.53	8.5	9.41	10.6	11.4	13.6	15.7	18.2	20.7
200	0.7	1.1	1.4	2.1	3	4	4.4	5.6	7.26	8.81	9.9	10.9	12.2	13	15.1	17.3	19.6	22.2
500	0.7	1.2	1.5	2.3	3.3	4.6	5.1	6.7	8.75	10.8	12	13.2	14.7	15.3	17.2	19.5	21.6	24.3
1000	8	1.2	1.5	2.5	3.6	5.2	5.7	7.5	10.1	12.7	14	15.3	16.8	17.4	19	21.3	23.2	25.8

### 8.6 Stormwater Quality Management

The purpose of this section is to ensure compliance with the water quality requirements for stormwater runoff from developed sites. Unlike the approach for volume and rate control, which considers the net change in hydrology resulting from land development, water quality evaluation begins by assuming that the built site will generate pollutants from the new or disturbed surfaces, and that the various BMPs can prevent or remove these pollutants from the resultant runoff. As discussed in Chapter 2, reduction of Non-point Source (NPS) pollutants by stormwater management is the primary issue of concern. If Control Guideline 1 or Control Guideline 2 are met for volume reduction, then it follows that the first flush of NPS pollutants have passed through one or more BMPs and the resultant runoff meets the water quality criteria, except for solutes. There is no consideration of any transport of pollutants that might be generated from the site before development, and the undisturbed portions of the site are to be ignored as sources of NPS pollution.

The use of infiltration measures to meet water quality criteria as well as volume reduction has one potential constraint; solutes, specifically nitrate, cannot be assumed to be sufficiently reduced by infiltration alone. To further complicate the nitrate issue, it has been observed that the concentration of nitrate in runoff remains fairly constant over the entire hydrograph, with some reduction by dilution during the peak flow period. As a solute, this means that the nitrate is dissolved in runoff throughout the rainfall process, and continues to move throughout the entire storm. In effect, the “first flush” approach used for particulate-associated pollutants does not apply, nor does the removal efficiency of the various BMP measures.

The non-structural measures discussed in Chapter 4 offer very efficient preventive answers to this issue, such as reduced fertilization, vegetative restoration and street sweeping. For the land development projects that apply these various non-structural measures, the overall pollutant load generated should be minimized for both particulates and solutes. If a project has preserved and restored the woodland vegetation on portions of the tract as an integral part of the development program, prevented compaction or restored permeability in disturbed soils, and

kept to an absolute minimum the chemical maintenance required for new landscaping elements, the pollutant load generated should be minimal, from a water quality perspective, and should not warrant regulatory control. The determination of how successful a given site design is in meeting water quality compliance with non-structural measures will be guided by the loading data analysis described in this Chapter. The initial load estimate of NPS pollution generated by the proposed building program will provide insight into the relative impact of different built surfaces on ambient water quality in a watershed.

### **8.6.1 Analysis of Water Quality Impacts from Developed Land**

Chapter 3 proposed criteria for three representative pollutants (Suspended Solids, Total Phosphorus and Nitrate) in terms of percent reduction of the anticipated load produced from the areas disturbed during construction. The specific values proposed for each pollutant are intended to reflect the potential efficiencies of the various BMPs considered, as well as the anticipated reduction required to sustain or restore water quality in receiving waters. The impact of NPS pollution on surface water quality is well documented, but generally in terms of the receiving water body. A reduction in ambient water quality in many major riverine, lacustrine and estuarine systems has usually been associated with changes in land use within the contributing drainage, and in some cases, specific pollutants have been identified as “key” pollutants. A study of the Lake Erie drainage basin in the mid-1960’s focused on phosphorus as the critical nutrient leading to trophic changes in the lake, and the resultant water quality strategy reduced this nutrient from both point sources and land runoff. The pattern of lake and estuary eutrophication has been repeated in countless water bodies across the US and throughout the world, and in virtually every drainage catchment, phosphorus is the limiting nutrient.

In the Chesapeake Bay drainage basin, which is largely provided by runoff from central Pennsylvania, both phosphorus and nitrate are considered limiting nutrients. These pollutants contribute to diminishing water quality and a loss of both habitat and species by enrichment of the estuary waters. A major initiative has recently been undertaken by states in the Chesapeake Bay drainage basin to significantly reduce both nutrients from wastewater effluent at over 350 treatment facilities, a process that will require an investment of hundreds of millions of dollars over the next decade (Chesapeake Bay Tributary Strategy, CEC, 8/12/04). In that program, PA must reduce nitrate by 48.2 million pounds and total phosphorus by 1.98 million pounds annually. Sediment has also played a major part in the reduction in water quality in the Bay. Therefore a dual effort of reducing nutrients and sediment from the land runoff must be included in any Bay recovery program, keeping in mind that the phosphorus is transported with the colloid fraction of sediments.

Thus all three of the selected NPS criteria are appropriate for water quality management of stormwater, not only in the Chesapeake bay drainage basin, but throughout the state. Again, these pollutants serve as surrogates for a wide range of other pollutants that occur in lesser or trace concentrations but also contribute to degraded water quality. Many of these other pollutants are also solutes, and so the focus on nitrate serves a broader function.

Table 8.3 summarizes the concentration of representative pollutants, both particulate and solute, that have been measured in the runoff from various built surfaces in a selected group of studies. In the preparation of this BMP Manual, a larger body of literature has been reviewed for comparative data, and is summarized in Appendix A. While this data is derived from numerous sources, the studies referenced were performed on very different sites, and measurement methods varied by investigator. The use of a value that represents the “mean”

concentration of a pollutant in runoff is very dependent on the level of detail applied in the development of this data. For the purposes of evaluating the water quality impacts of land development and the benefits of a given BMP in reducing this pollution, the data were expanded to consider variations in land cover type, and are shown in Table 8.3.

It is possible that a proposed development may not conform exactly to the land cover categories shown in this Table. Independent sampling of representative stormwater chemistry from similar sites can be prepared by a developer or other interested party, if desired. It is recommended that any stormwater sampling be compiled by use of automated sampling equipment at flow measurement stations, where the record of chemical variability during runoff incidents can be gathered, and that the Department approves the program prior to initiation. These new sampling data should allow the integration of hydrographs and chemographs to formulate mass transport loads and develop flow-weighted concentrations for analysis and substitution in lieu of Table 8.3 values.

In the absence of new sampling data prepared by a developer or other applicant, the values shown in Table 8.3 will be applied to the volume of runoff estimated from new development for completion of Worksheets. The concept of “Event Mean Concentration” was explained in Chapter 2, and represents the anticipated average concentration of a given pollutant that could be scoured from a given surface during a storm event of significant magnitude to produce surface runoff. No specific rainfall amount is applied to this term, and the body of data from which it is derived reflects very different hydrologic conditions.

TABLE 8.3. EVENT MEAN CONCENTRATIONS (EMCs)

	LAND COVER CLASSIFICATION	POLLUTANT		
		Total Suspended Solids, EMC (mg/l)	Total Phosphorus, EMC (mg/l)	Nitrate-Nitrite EMC (mg/l as N)
Pervious Surfaces	Forest	39	0.15	0.17
	Meadow	47	0.19	0.3
	Fertilized Planting Area	55	1.34	0.73
	Native Planting Area	55	0.4	0.33
	Lawn, Low-Input	180	0.4	0.44
	Lawn, High-Input	180	2.22	1.46
	Golf Course Fairway/Green	305	1.07	1.84
	Grassed Athletic Field	200	1.07	1.01
Impervious Surfaces	Rooftop	21	0.13	0.32
	High Traffic Street / Highway	261	0.4	0.83
	Medium Traffic Street	113	0.33	0.58
	Low Traffic / Residential Street	86	0.36	0.47
	Res. Driveway, Play Courts, etc.	60	0.46	0.47
	High Traffic Parking Lot	120	0.39	0.6
	Low Traffic Parking Lot	58	0.15	0.39

### 8.6.2 Analysis of Water Quality Benefits from BMPs

Unlike the traditional approach to wastewater, the implementation of stormwater quality criteria is intended to change development practices and land management concepts, rather than to establish a series of treatment or pollutant removal methodologies. As a general rule, the removal of pollutants, both particulate and dissolved, from stormwater is a difficult and inefficient process. Because the rate of flow from a developed site, as well as the concentration of many pollutants, varies greatly during a storm, the use of traditional wastewater “unit operation” technologies is inappropriate. The intermittent nature of runoff also complicates the pollutant removal process. NPS pollution is produced in concentrated “slugs” of runoff, and not contained in a uniform flow that can be applied to a microbial based process in a medium or structure, such as a sewage treatment plant. Finally, the form of NPS pollutant, particulate or solute, determines the potential for removal by any physical BMP.

The BMPs described in detail in Chapters 5 and 6 represent a variety of measures that, generally speaking, have not been broadly applied during the past twenty-five years for water quality mitigation on land development projects throughout the state. A number of wet extended detention basins have been built, as a variation on the conventional detention basin, but most of these have not been subject to detailed monitoring that would quantify water quality benefits. Infiltration BMPs have also seen limited application in PA, but again virtually none have had thorough scientific monitoring measures included in their design. Several dozen porous pavement systems have been built since 1981, largely in the southeast area of the state, but even these systems have had little water quality monitoring data developed, simply because the site owner declined to participate in and support such a program. Other infiltration measures, including trenches, rain gardens and cisterns, have been built on a limited number of sites, but these have also not been designed to provide sample collection from the unsaturated zone or groundwater beneath the BMP. Thus the scientific basis for pollutant removal efficiency is derived from other relevant literature, especially the soil sciences and agriculture.

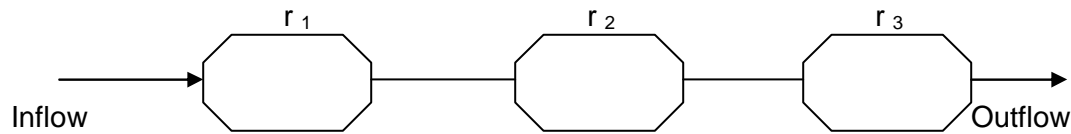
The most complete record of pollutant removal efficiency for BMPs is based on surface detention basins, as modified to include standing water, vegetation, multiple pond systems and the like. While simple detention structures can provide significant reduction of Suspended Solids, especially the larger particulate fraction, the NPS pollutant removal process is greatly enhanced by these modifications. For the other BMPs, the evaluation process is largely a work in progress. A review of the available literature, included in Appendix A, suggests a range of benefits from BMPs, including their relative efficiency of pollutant reduction, removal or prevention, as summarized in Appendix A.

The available water quality data demonstrates that the roof areas of structures will not contribute a significant fraction of the total pollutant load, and can generally be ignored, since much of the pollution washed from rooftops is comprised of atmospheric deposition. For “big box” projects this may not necessarily be true because of the relative size and proportion, and the potential loading analysis should guide the designer in this step. The estimate of NPS pollution produced by a built site can be simplified by ignoring rooftop runoff and undisturbed land areas as NPS sources. The analysis effectively limits the contributing surfaces to two major categories; impervious pavements and chemically maintained landscapes. Both of these types of surfaces can vary in their pollutant contribution, as illustrated by Table 8.3. In many if not most new developments, the evaluation and reduction of pollutant impacts will focus on these two types of sources.

All infiltration BMPs shown in Table 8.4 assume the NPS pollutant removal efficiency for both TSS and TP is 85%, although an efficiency of close to 100% is reasonable for all infiltrated runoff. Any runoff greater than the design storms of Volume Control Guidelines 1 and 2 probably will overflow or bypass these BMPs, and so some NPS load during major storms will discharge to surface waters. For the situation where an infiltration BMP is in close proximity to a potable water supply source, the potential for contamination by solutes must be considered, and additional BMPs applied if the site conditions warrant (e.g., groundwater concentration exceeds 10 mg/l).

Compliance with Volume Control Guidelines 1 and 2 requires the site plan to optimize runoff capture, ideally with distributed BMPs. If they consist of a single measure or multiple measures distributed across the site, the first question is the amount of total built surface that drains to one or more BMP. This “capture efficiency” of the stormwater management system determines not only hydraulic capacity of any given measure, but also how much of the site is controlled in terms of pollutant containment. It is recognized that most site designs do not allow total capture of all runoff, no matter how flat the parcel may be. Completion of the Worksheets for either volume control guideline will result in a design capacity for the selected BMPs, which usually can be aggregated by type for analysis of water quality impacts. That is, multiple small measures such as rain gardens in a residential development can be treated as a single measure in terms of pollutant reduction.

The removal efficiency of BMPs connected either in series or in parallel may be computed using the two equations provided below. Figures 8-1 and 8-2 below illustrate BMPs connected in series and in parallel.



**Fig. 8-1.** BMPs Connected in Series

**Equation for removal efficiency of BMPs in series:**

$$R = 1 - \prod_{i=1}^n (1 - r_i)$$

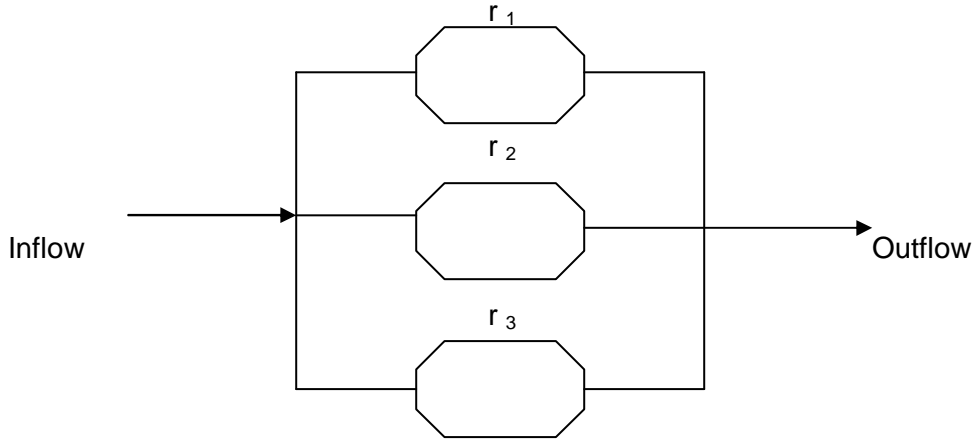
R = Removal efficiency of n BMPs in series.

r<sub>i</sub> = Removal efficiency of BMP<sub>i</sub>

The removal efficiency R of the above three BMPS in series is,

$$R = 1 - \{(1 - r_1) * (1 - r_2) * (1 - r_3)\}$$





**Fig. 8-2.** BMPs Connected in Parallel

**Equation for removal efficiency of BMPs in connected in parallel:**

$$R = 1 - \frac{\sum_{i=1}^n C_i Q_i (1 - r_i)}{\sum_{i=1}^n C_i Q_i}$$

$R$  = Removal efficiency of  $n$  BMPs in parallel.

$Q_i$  = Rate of flow  $i$  passing through  $BMP_i$ .

$C_i$  = Concentration of pollutant in flow  $i$ .

$r_i$  = Removal efficiency of  $BMP_i$ .

The removal efficiency  $R$  for the three BMPs shown in **Fig. 8-2** is,

$$R = \frac{C_1 Q_1 (1 - r_1) + C_2 Q_2 (1 - r_2) + C_3 Q_3 (1 - r_3)}{C_1 Q_1 + C_2 Q_2 + C_3 Q_3}$$

### 8.6.3 Water Quality Analysis

Confirmation that the BMP program has been successful in meeting the water quality criteria assumes that either Volume Control Guideline 1 or 2 have been met, and that at least 90% of the disturbed area is conveyed or mitigated by a BMP (Flow Chart D – page 40). Compliance with the volume criteria assumes that the major portion of particulate pollutants have been removed from runoff by one or more BMP, and so the only additional demonstration required for compliance with water quality criteria is to confirm that one or more of the BMPs that are most effective in solute reduction have been included in the stormwater management program.

Worksheet 10 is a simple checklist of those measures, and is divided into two categories, primary and secondary. Without performing a detailed loading analysis, the inclusion of a combination of these measures should provide adequate demonstration that the site design has considered this issue and incorporated the best feasible solution.

Worksheet 11 is intended for those sites where volume reduction cannot be met. This form estimates the total pollutant load produced from all built surfaces, so that the designer can appreciate the relative magnitude of the problem created by the proposed design. Where the site design provides insufficient capture by BMPs, the designer should revisit the overall program and apply additional measures to meet water quality criteria. That is, even if site constraints prevent compliance with Volume Control Guideline 1 and 2, water quality criteria should still be met.

In many site designs where NPS reduction is a concern, it is usually obvious that the greatest pollutant impact is from two surfaces; impervious pavements and fertilized landscapes. As designers focus attention on the uncontrolled runoff from streets and fertilized landscapes and revisit the water quality impacts, the value of non-structural measures, including street sweeping and the use of native plantings for landscape design, should become apparent.

Worksheets 12 and 13 indicate the uncontrolled load from built surfaces and gives credit for load reduction and source omissions by using the full array of non-structural and structural BMPs. It is likely that if compliance with Volume Control Guideline 1 and 2 is not feasible, no additional structural measures can be included without major site plan redesign. That option is not excluded, but if non-structural measures can be incorporated, then the answer is simple, and additional structural measures may not be required. The designer can turn to land management measures that can be incorporated in the finished building program without any structural alterations. Clearly, it will require creative design to meet the recommended water quality goals, but it is well within the capabilities of the BMPs described in this Manual.

## **8.7 Guidance for Stormwater Calculations for Volume Control Guideline 1 and Volume Control Guideline 2**

Stormwater management in Pennsylvania has historically focused on flow rate control for large storm events. Stormwater management has traditionally required that there be no increase in the rate of runoff from development as compared to the rate of runoff before development for storm events ranging from the 2-year, 24-hour event to the 100-year, 24-hour event. The *Pennsylvania Stormwater Best Management Practices Manual* is recommending that stormwater management be expanded to include:

- Rate of flow
- Volume of flow
- Groundwater recharge
- Water quality
- Stream channel protection

Volume Control Guideline 1 and Volume Control Guideline 2 provide recommended guidelines to achieve these stormwater management elements.

It should be noted that control of the rate of flow of stormwater runoff remains an important part of stormwater management. This criteria is generally based on larger storm events of limited frequency (i.e., the 1-year through the 100-year storm events).

By contrast, the additional elements of stormwater management – volume, groundwater recharge, water quality, and stream channel protection – are based on the smaller, more frequent storm events. Effective stormwater management includes rate control and the additional elements of volume, groundwater recharge, water quality, and stream channel protection.

Engineers and regulatory officials are familiar with the engineering methods and models used to evaluate the rate of runoff for large storm events. There is general consistency in the calculation methodologies used across the state, with the Cover Complex Method or the Rational Method being the two most common methodologies applied to estimate rate of runoff.

To manage stormwater for volume, ground water recharge, quality, and channel protection, additional or expanded analytical methods are needed. The following sections provide guidance on recommended procedures and methodologies to improve stormwater management, and include worksheets and flow charts intended to assist in this process.

### 8.7.1 Stormwater Calculation Process

Flow Chart A (page 31) is provided to guide the user in the first step of the stormwater calculation process (*Stormwater Calculation Process Non-structural BMPs*).

- Step 1: Provide General Site information (Worksheet 1).
- Step 2: Identify sensitive natural resources, and if applicable, identify which areas will be protected (Worksheet 2).
- Step 3: Incorporate Non-structural BMPs into the stormwater design. Quantify the volume benefits of Non-structural BMPs (Worksheet 3).

Proceed to either Flow Chart B, Volume Control Guideline 1 or Flow Chart C, Volume Control Guideline 2.

#### 8.7.1.1 For Volume Control Guideline 1 (Flow Chart B)

- Step 4: Estimate the increased volume of runoff for the 2-Year storm event, using the Cover Complex Curve Number method. **Combining Curve Numbers for land areas proposed for development with Curve Numbers for areas unaffected by the proposed development into a single weighted curve number is NOT acceptable.** Runoff volume should be calculated based on land use and soil types (Worksheet 4).
- Step 5: Design and incorporate Structural and Non-Structural BMPs that provide volume control for the 2-Year volume increase indicated on Worksheet 4. Provide calculations and documentation to support the volume estimate provided by BMPs. For Non-structural BMPs, provide Non-structural BMP checklists to demonstrate that BMPs are appropriate. Indicate the volume reduction provided by BMPs (Worksheet 5). *Note: if the designer is unable to incorporate the 2-year volume increase after all feasible BMP*

*options have been considered, the designer proceeds to Volume Control Guideline 2.*

- Step 6: Determine if the site is exempt from peak rate calculations (Worksheet 6).
- Step 7: If the site is NOT exempt from peak rate calculations, provide detailed routing analysis to demonstrate peak rate control for the 1-year through 100-year storm events. This routing should consider the benefits of BMPs. Provide additional detention capacity if needed.

Proceed to Flow Chart D, Water Quality Calculations

### **8.7.1.2 For Volume Control Guideline 2 (Flow Chart C)**

This guideline integrates water quality, stream channel protection, and groundwater recharge requirements into a simplified statement that can be implemented with relatively easy computations. The guideline uses runoff depth rather than precipitation to compute required capture volumes. The total capture volume of 2 inches corresponds roughly to the state-wide average runoff produced by a 1-year 24-hour storm on an impervious surface. One-half of the captured volume may be released slowly, one-fourth is recommended for reuse, and one-fourth is recommended for groundwater recharge. These recommended values are based on a generalized water budget analysis. During the development of watershed-based stormwater management plans, the analysis can be re-computed to derive values that reflect local watershed conditions more accurately (e.g. Act 167 plans). The generalized version of Volume Control Guideline 2 is as follows:

- Step 4: Capture the first 2 inches of runoff from all contributing impervious surfaces. The first 1-inch of runoff should be permanently removed and not be released to the Surface Waters of the Commonwealth. The other 1 inch of runoff should be detained. Compute Runoff Volumes using **Worksheet 7**.
- Step 5: Design and incorporate Structural and Non-Structural BMPs that provide permanent removal for the PRV and extended detention. The removal options for PRV include reuse, evaporation, transpiration, and infiltration. Infiltration for the first 0.5 inch is encouraged. Documentation to support the computations for volumes can be provided using Worksheet 8. For Non-structural BMPs, checklists can be used to demonstrate that selected BMPs are appropriate. Indicate the volume reduction provided by BMPs on **Worksheet 8**.
- Step 6: Provide detailed routing analysis to demonstrate peak rate control for the 2-year through 100-year storm events. This routing should consider the benefits of BMPs.

Proceed to Water Quality Calculations (Flow Chart D), Step 8.

## 8.7.2 Water Quality Calculations (Flow Chart D)

- **Step 8:** Determine if the stormwater management design complies with either Volume Control Guideline 1 or 2 . If volume compliance is achieved under either of these guidelines, proceed to Step 9. If compliance is not achieved, proceed to Step 11.
- **Step 9:** Determine if at least 90% of the disturbed site area is controlled by a BMP (maximum disturbed, uncontrolled area of 10%). To be considered “controlled” by a BMP, the disturbed area must either drain to a structural BMP (or series of BMPs) or be off-set by a preventive BMP, such as reduced imperviousness or landscape restoration. If at least 90% of the disturbed area is controlled, proceed to Step 10; else proceed to Step 12.
- **Step 10:** TSS and TP requirements are considered met. Demonstrate use of specific nitrate prevention/reduction BMPs (Worksheet 10). If the required BMPs (2 primary or 4 secondary or 1 primary and 2 secondary) are proposed within the stormwater management plan, then the water quality requirement for nitrate is achieved. If the required BMPs are not proposed, proceed to Step 11.
- **Step 11:** If neither Control Guideline is met for volume control, demonstrate use of specific BMPs for pollutant prevention (Worksheet 11).
- **Step 12:** Estimate pollutant load from disturbed areas of the site, excluding preventive measures (if proposed). (Worksheet 12).
- **Step 13:** Calculate pollutant load reductions with the proposed structural BMPs (**Worksheet 13**). If target load reductions are achieved for TSS, TP, and nitrate, then the water quality requirements are met.

## 8.8 Non-Structural BMP Credits

The use of Non-structural BMPs is an important part of a project’s stormwater management system. However, the BMPs must be correctly implemented to be effective.

For the Non-Structural BMPs applied, use the appropriate checklists to demonstrate that BMPs are applicable to project.

Worksheet 3 determines the amount of Volume credit or Peak Rate credit associated with Non-structural BMPs.

The following BMPs are “self-crediting” in that the use of these BMPs automatically provides a reduction in impervious area and a corresponding reduction in stormwater impacts. Additionally, the use of these BMPs may be regulated by local ordinances. Local governments and reviewing agencies are encouraged to promote the use of these BMPs where feasible:

- BMP 5.5.1 Cluster Uses
- BMP 5.5.2 Concentrate Uses through Smart Growth
- BMP 5.7.1 Reduce Street Imperviousness
- BMP 5.7.2 Reduce Parking Imperviousness

The following BMPs provide a quantitative runoff volume reduction:

- BMP 5.4.1 Protect Sensitive/Special Value Features
- BMP 5.4.2 Protect/Conserve/Enhance Riparian Areas
- BMP 5.4.3 Protect/Utilize Natural Flow Pathways
- BMP 5.6.1 Minimize Disturbed Area
- BMP 5.6.2 Minimize Soil Compaction in Disturbed Areas
- BMP 5.6.3 Re-Vegetate and Re-Forest Disturbed Areas
- BMP 5.8.1 Rooftop Disconnection
- BMP 5.8.2 Disconnection from Storm Sewers

References that support the quantitative BMP volume reduction are provided at the end of this chapter. **No more than 25% of the Volume Reduction may be met through Non-Structural BMP credits.**

**Criteria and Credits for BMP 5.4.1 Protect Sensitive/Special Value Features**

To receive credit, the proposed areas:

- Shall include natural areas of floodplains, mapped wetlands, mapped woodlands, and natural slopes over 15% and 25%.
- May include other areas of significant natural resources that the applicant demonstrates are of special natural value.
- Shall not be disturbed during project construction (i.e., cleared or graded) except for temporary impacts associated with mitigation and reforestation efforts. Utility disturbance is discouraged and should be kept to a minimum.
- Shall be protected by having the limits of disturbance clearly shown on all construction drawings and delineated in the field.
- Shall be located within an acceptable land preservation/protection agreement or other enforceable instrument, such as a deed restriction, that ensures perpetual protection of the proposed areas. The preservation agreement shall clearly specify how the natural area shall be managed and boundaries will be marked with permanent survey markers.
- Managed turf is not considered an acceptable form of vegetation management.
- Shall be located on the development project.

**CREDITS****Volume and Quality**

Protected Area is not to be included in Runoff Volume calculation

$$\text{Stormwater Management Area} = (\text{Total Area} - \text{Protected Area})$$

**Peak Rate and Channel Protection**

Runoff from the Protected Area may be excluded from Peak Rate calculations and Channel Protection calculations for rate control, provided that the runoff from the protected area is not conveyed to and/or through stormwater management control structures. If necessary, runoff from Protected Areas should be directed around BMPs and stormwater pipes and inlets by means of vegetated swales or low berms that direct flow to natural drainage ways.

**Criteria and Credits for BMP 5.4.2 Protect/Conserve/Enhance Riparian Areas**

To receive credit, the Riparian Buffer Protection areas:

- Shall include a minimum width of 25 feet from each streambank for Zone 1. Smaller widths do not receive credit.
- Shall include a minimum width of 75 feet from each streambank for Zone 2. Smaller widths do not receive credit.
- Shall not be disturbed during project construction (i.e., cleared or graded) except for temporary impacts associated with mitigation and afforestation efforts. Utility disturbance is discouraged and should be kept to a minimum.
- Areas disturbed for stream crossings (temporary or permanent) do not receive credit.
- Shall be protected by having the limits of disturbance clearly shown on all construction drawings and delineated in the field.
- Shall be located within an acceptable land preservation/protection agreement or other enforceable instrument, such as a deed restriction, that ensures perpetual protection of the proposed areas. The preservation agreement shall clearly specify how the Riparian Buffer shall be managed and boundaries will be marked with permanent survey markers.
- Managed turf is not considered an acceptable form of vegetation management within Zone 1 or Zone 2.
- Zone 1 shall not be subject to point discharges for the entire length of Zone 1. Zone 2 shall not be subject to point discharges unless the use of a level spreader or similar device is implemented.
- Shall be located on the development project.
- Forested Buffers are encouraged. See BMP 5.6.3 for Tree Planting Credit.

**CREDITS**

**Volume and Quality**

Protected Area in Zone 1 and/or Zone 2 is not to be included in Runoff Volume calculation or Water Quality volume

$$\text{Mitigation Area} = (\text{Total Area} - \text{Protected Area})$$

**Peak Rate and Channel Protection**

Runoff from the Protected Area may be excluded from Peak Rate calculations and Channel Protection calculations for rate control, provided that the runoff from the protected area is not conveyed to and/or through stormwater management control structures. If necessary, runoff from Protected Areas should be directed around BMPs and stormwater pipes and inlets by means of vegetated swales or low berms that direct flow to natural drainage ways.



**Criteria and Credits for BMP 5.4.3 Protect/Utilize Natural Flow Pathways in Overall Stormwater Planning and Design**

To receive credit, the proposed natural Drainage Features:

- Shall include natural swales and drainage pathways that existed prior to development and that will receive runoff from developed areas, including intermittent drainage areas and intermittent wetland depressions. Manmade drainage features are not included.
- May use check dams, low berms, native vegetation, and limited grading to improve natural drainage features.
- Shall be designed to receive runoff such that flows after development are non-erosive. Care must be taken to maintain the non-erosive conditions and natural systems should not be overloaded.
- Shall be protected from compaction or unintended disturbance during construction by having the limits of disturbance clearly shown on all construction drawings and delineated in the field.
- Shall be noted on stormwater management plans as part of stormwater management system and included in any municipal easement requirements for stormwater systems. Such areas shall be noted on parcel deeds and protected from future encroachment or disturbance by deed restrictions.
- Shall be located on the development project.
- May not include perennial streams.
- Does not include Constructed Vegetated Swales and Vegetated Filter Strips

**CREDITS**

**Volume and Quality**

A Volume Reduction may be credited based upon the area of the Natural Drainage Feature that is vegetated.

$$\text{Volume Reduction (ft}^3\text{)} = \text{Area} \times \frac{1}{4}\text{-inch runoff}$$

$$= \text{Vegetated Area of Natural Drainage Feature (ft}^2\text{)} \times \frac{1}{4} / 12$$

*Note: A greater volume credit may be requested by the applicant if calculations support a greater numerical value to Minimizing Soil Compaction.*

**Peak Rate and Channel Protection**

The Peak Rate is reduced by a longer travel time of runoff through Natural Drainage Features. The Time of Travel (Tt) after development may be considered the same as the Tt before development for flows through Natural Drainage Features.

When calculating flow rates:

$$Tt_{\text{BEFORE}} = Tt_{\text{AFTER}}$$

**Criteria and Credits for BMP 5.6.1 Minimize Total Disturbed Area - Grading**

To receive credit, areas of Minimized Disturbance/Grading must meet the following criteria:

- Area shall not be subject to grading or movement of existing soils.
- Existing native vegetation in a healthy condition may not be removed.
- Invasive non-native vegetation may be removed.
- Pruning or other required maintenance of vegetation is permitted. Additional planting is permitted.
- Area shall be protected by having the limits of disturbance clearly shown on all construction drawings and delineated in the field.
- The area not subject to grading shall be clearly delineated on the Stormwater Management Plan. If future grading or disturbance of this area occurs, subsequent stormwater management must be provided to address disturbance.
- Shall be located on the development project.

**CREDITS**

**Volume and Quality**

Protected Area is not to be included in Runoff Volume calculation or Water Quality volume

Mitigation Area = (Total Area – Protected Area)

**Peak Rate and Channel Protection**

Runoff from the Protected Area (area not subject to grading) may be excluded from Peak Rate calculations and Channel Protection calculations for rate control, provided that the runoff from the protected area is not conveyed to and/or through stormwater management control structures. If necessary, runoff from Protected Areas should be directed around BMPs and stormwater pipes and inlets by means of vegetated swales or low berms that direct flow to natural drainage ways.

**Criteria and Credits for BMP 5.6.2 Minimize Soil Compaction in Disturbed Areas**

To receive credit, areas of Minimal Soil Compaction must meet the following criteria:

- Area shall NOT be stripped of existing topsoil.
- Area shall not be subject to excessive equipment movement. Vehicles movement, storage, or equipment/material laydown shall not be permitted in areas of Minimized Disturbance/Grading.
- The area shall be protected by having the limits of disturbance and access clearly shown on the Stormwater Management Plan, all construction drawings and delineated in the field.
- The use of soil amendments and additional topsoil is permitted. Light grading may be done with tracked vehicles that prevent compaction.
- Lawn and turf grass are acceptable uses. Planted Meadow is an encouraged use.
- Area shall be located on the development project.

**CREDITS**

**Volume and Quality**

A Volume Reduction may be credited based upon the area of Minimal Soil Compaction.

For Lawn Areas:

$$\text{Volume Reduction (ft}^3\text{)} = \text{Area of Min. Soil Compaction (ft}^2\text{)} \times \frac{1}{4} / 12$$

*For Meadow Areas:*

$$\text{Volume Reduction (ft}^3\text{)} = \text{Area of Min. Soil Compaction (ft}^2\text{)} \times \frac{1}{3} / 12$$

Note: The applicant may request a greater volume credit if calculations support a greater numerical value to Minimizing Soil Compaction.

**Peak Rate and Channel Protection**

The Peak Rate for flood protection and channel protection will be reduced by the reduction in runoff volume provided above.

**Criteria and Credits for BMP 5.6.3 Re-Vegetate and Re-Forest Disturbed Areas, Using Native Species**

This BMP includes both Protection of Existing Trees and Re-forestation:

**Part 1 Protect Existing Trees**

To receive credit for protecting existing trees **NOT** located within Sensitive/Special Value areas, the following criteria must be met:

- Trees shall be protected by having the limits of disturbance clearly shown on all construction drawings and delineated in the field.
- Protection during construction shall entail minimizing disruption of the root system; construction shall not encroach within a space measured 10 feet outside of the drip line to the tree trunk.
- Trees credited for stormwater management shall be clearly labeled on the construction drawings and recorded on Record Plan for project.
- Trees shall be maintained and protected for the life of the project (50 years) or until redevelopment occurs.
- No more than 25% of the runoff volume can be mitigated through the use of trees.
- Pruning or other required maintenance of existing vegetation is permitted for safety purposed only, unless near a building.
- Escrow shall be provided for the replacement of any protected trees used for stormwater credit that die within 5 years of construction. Dead trees shall be replaced within 6 months.
- Shall be located on the development project.
- Existing tree canopy must be within 100 feet of impervious surfaces to gain credit.
- Only applies for trees outside Sensitive/Special Value areas.
- Applies to existing trees of 4-inch caliper or larger. Non-native species are not applicable.

**CREDITS**

**Volume and Quality**

A Volume Reduction may be credited based upon the existing tree canopy.

*For Trees within 100 feet of impervious cover:*  

$$\text{Volume Reduction (ft}^3\text{)} = \text{Existing Tree Canopy (ft}^2\text{)} \times 1/2" / 12$$

**Peak Rate and Channel Protection**

The Peak Rate for flood protection and channel protection will be reduced by the reduction in runoff volume provided above.

**Part 2 Revegetate and Reforest**

To receive credit for planting trees, the following criteria must be met:

- Trees must be native species (see Appendix), minimum 2” caliper. Minimum tree height is 6 feet.
- Trees shall be adequately protected during construction.
- Trees credited for stormwater management shall be clearly labeled on the construction drawings and recorded on Record Plan for project.
- Trees shall be maintained and protected for the life of the project (50 years) or until redevelopment occurs.
- No more than 25% of the runoff volume can be mitigated through the use of trees.
- Escrow shall be provided for the replacement of any protected trees used for stormwater credit that die within 5 years of construction. Dead trees shall be replaced within 6 months.
- Shall be located on the development project.
- May be applied for trees required under Street Tree or Landscaping requirements.
- May be applied for trees planted as part of Riparian Buffer improvement.
- Non-native species are not applicable.

**CREDITS  
Volume and Quality**

A Volume Reduction may be credited based upon the existing tree canopy.

*For Deciduous Trees:*  
Volume Reduction (ft<sup>3</sup>) = 6 ft<sup>3</sup>

*For Evergreen Trees:*  
Volume Reduction (ft<sup>3</sup>) = 10 ft<sup>3</sup>

**Peak Rate and Channel Protection**

The Peak Rate for flood protection and channel protection will be reduced by the reduction in runoff volume provided above.

**Criteria and Credits for BMP 5.8.1 Rooftop Disconnection**

To receive credit, Rooftop Disconnection Areas must meet the following criteria:

- Roof leaders are directed to a pervious area where runoff can either infiltrate into the soil or filter over it.
- Shall be located on the development project.
- The use of soil amendments and additional topsoil is permitted.
- Lawn and turf grass are acceptable uses. Planted Meadow is an encouraged use.
- Shall be noted on stormwater management plans as part of stormwater management system and included in any municipal easement requirements for stormwater systems.
- Rooftop cannot be within a designated hotspot.
- Disconnection shall not cause basement seepage.
- The contributing rooftop area to each disconnection point shall be 500 sf or less. For greater areas, see BMP 6.20 Level Spreader.
- The length of the disconnection shall be 75 feet or greater.
- Dry wells, french drains, recharge gardens, infiltration trenches/beds, or other similar storage devices may be utilized to compensate for areas with disconnection lengths less than 75 feet. (Do not credit BMP 5.11)
- In residential development applications, disconnections will only be credited for lot sizes greater than 6000 sf.
- The entire vegetated “disconnection” area shall have a maximum slope of 5%.
- The disconnection must drain continuously through a vegetated swale or filter strip to the property line or BMP.
- Roof downspouts shall be at least 10 feet away from the nearest impervious surface to discourage “re-connections”
- For rooftops draining directly to a buffer, only the rooftop disconnection credit of the buffer credit may be used, not both.

**CREDITS**

**Volume and Quality**

Volume Reduction (ft<sup>3</sup>) = Contributing Rooftop Area (ft<sup>2</sup>) x 1/4” / 12

*Note: The applicant may request a greater volume credit if calculations support a greater numerical value to Minimizing Soil Compaction.*

**Peak Rate and Channel Protection**

The Peak Rate for flood protection and channel protection will be reduced by the reduction in runoff volume provided above.

### Criteria and Credits for BMP 5.8.2 Disconnection from Storm Sewers

To receive credit, the following must be met:

- Runoff from the non-rooftop impervious cover shall be directed to pervious areas where it is infiltrated into the soil.
- May include Vegetated Swales as outlined in BMP 6.8.
- May include check dams, low berms, native vegetation, and limited grading to improve natural drainage features.
- Shall be designed such that flows after development are non-erosive.
- Shall be protected from compaction or unintended disturbance during construction by having the limits of disturbance clearly shown on all construction drawings and delineated in the field.
- Shall be noted on stormwater management plans as part of stormwater management system and included in any municipal easement requirements for stormwater systems.
- Shall be located on the development project.
- Runoff cannot originate from a designated hotspot.
- The maximum contributing impervious flow path length shall be 75 feet.
- The disconnection shall drain continuously through a vegetated swale or filter strip, or planted area to the property line or BMP.
- The length of the disconnection area must be at the least the length of the contributing area.
- The entire vegetated “disconnection” area shall have a maximum slope of 5%.
- The contributing impervious area to any one discharge point shall not exceed 1000 ft<sup>2</sup>.
- Disconnections are encouraged on relatively well-draining soils (HSG A & B).
- If the site cannot meet the required disconnect length, a level-spreading device, recharge garden, infiltration trench, or other storage device may be needed for compensation.

#### CREDITS

##### Volume and Quality

Volume Reduction (ft<sup>3</sup>) = Contributing Impervious Area (ft<sup>2</sup>) x 1/4" / 12

*Note: A greater volume credit may be requested by the applicant if calculations support a greater numerical value to Minimizing Soil Compaction.*

##### Peak Rate and Channel Protection

The Peak Rate for flood protection and channel protection will be reduced by the reduction in runoff volume provided above.

## Supporting Documentation

### Natural Drainage Swales (BMP 5.4.3)

“Headwater streams and wetlands have a particularly important role to play in recharge. These smallest upstream components of a river network have the largest surface area of soil in contact with available water, thereby providing the greatest opportunity for recharge of groundwater. Moreover, water level in headwater streams is often higher than the water table, allowing water to flow through the channel bed and banks into soil and groundwater. Such situations occur when water levels are high, such as during spring snowmelt or rainy seasons.” “Headwaters can be intermittent streams that flow briefly when snow melts or after rain, but shrink in dry times to become individual pools filled with water...wetlands are depressions in the ground that hold water whether from rainwater, snowmelt, or groundwater welling up to the surface.”

The scientific Imperative for Defending Small streams and Wetlands Judy L. Meyer, PhD, et al, American Rivers, September 2003

### Trees (BMP 5.6.3)

“Besides taking in carbon dioxide and putting out oxygen, trees have an enormous impact on temperature. As much as 90 percent of the solar energy is absorbed. Trees also cool by transpiration, the evaporation of water from their leaves. A medium sized tree can move more than 500 gallons of water into the air on a hot day, thereby reducing air temperature.”

The Natural Habitat Garden by Ken Druse with Margaret Roach, Timber Press 2004.

500 gal = 66.8 cf

### Volume Credits (BMPs 5.4.3; 5.6.2; 5.8.2)

Protect natural drainage ways, avoiding compaction, and disconnecting impervious areas all contribute to a reduction in the volume of runoff and the rate of runoff. The amount of reduction will vary depending on the site-specific conditions, including soil type, cover, etc. The designer may request additional volume credit by providing supporting calculations. The following table compares the difference in runoff volume for protected versus disturbed area for three storm events (1.5-inch, 2.7-inch, and 3.3-inch) for different soil types using the Cover Complex Method.

#### For 1.5" Rainfall

	A soil	B soil	C soil	D soil
Runoff Before	0	0.00	0.10	0.23
Runoff After	0.00	0.07	0.26	0.41
Difference	<b>0.00</b>	<b>0.07</b>	<b>0.16</b>	<b>0.18</b>

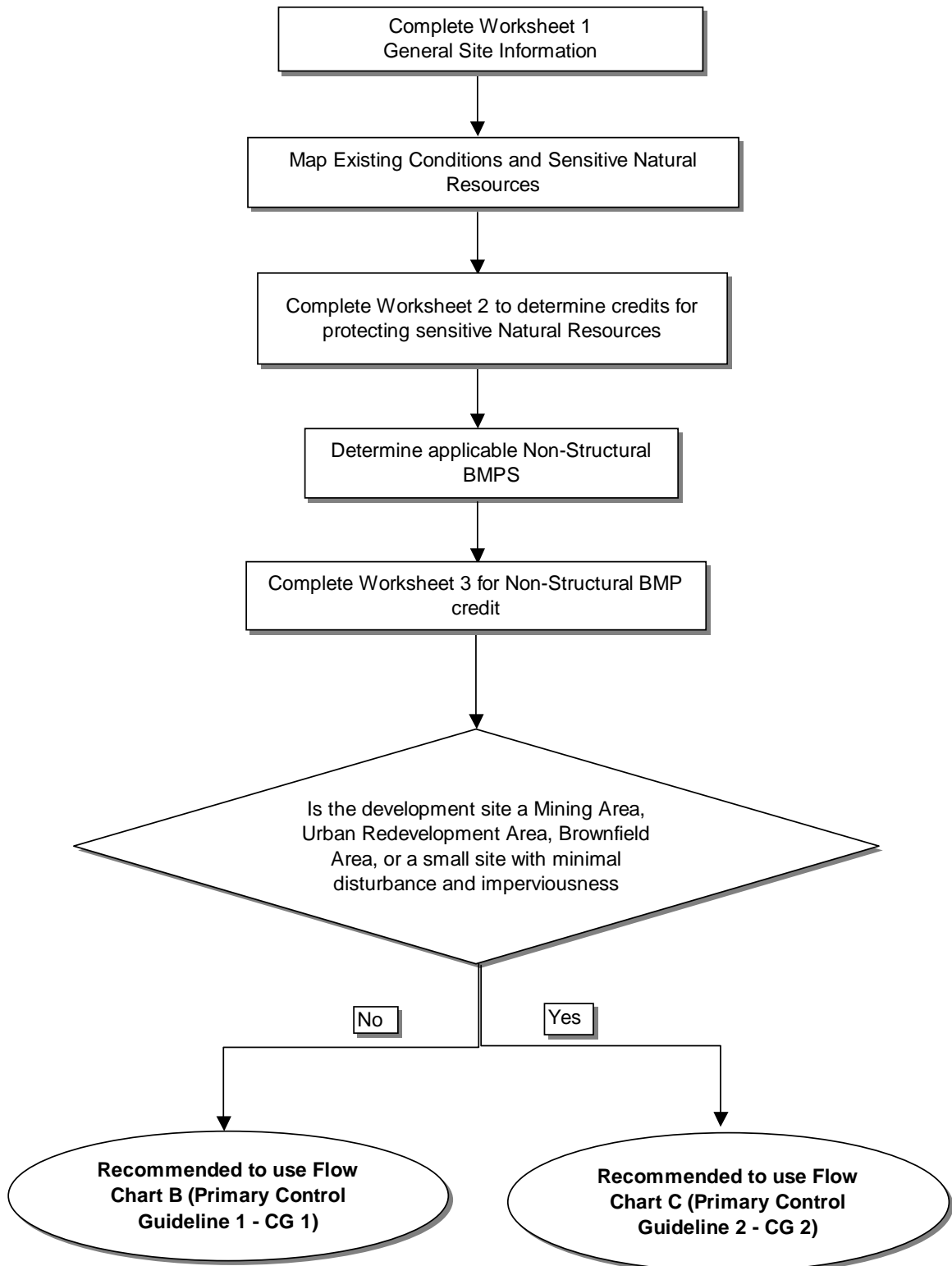
#### For 2.7" Rainfall

	A soil	B soil	C soil	D soil
Runoff Before	0	0	0.59	0.92
Runoff After	0.03	0.52	0.97	1.27
Difference	<b>0.03</b>	<b>0.52</b>	<b>0.38</b>	<b>0.35</b>

#### For 3.3" Rainfall

	A soil	B soil	C soil	D soil
Runoff Before	0	0.38	0.94	1.35
Runoff After	0.13	0.84	1.41	1.77
Difference	<b>0.13</b>	<b>0.46</b>	<b>0.47</b>	<b>0.42</b>





<b>Worksheet 1. General Site Information</b>	
<b>INSTRUCTIONS:</b> Fill out Worksheet 1 for each watershed	
<b>Date:</b>	_____
<b>Project Name:</b>	_____
<b>Municipality:</b>	_____
<b>County:</b>	_____
<b>Total Area (acres):</b>	_____
<b>Major River Basin:</b>	_____
	<a href="http://www.dep.state.pa.us/dep/deputate/watermgt/wc/default.htm#newtopics">http://www.dep.state.pa.us/dep/deputate/watermgt/wc/default.htm#newtopics</a>
<b>Watershed:</b>	_____
<b>Sub-Basin:</b>	_____
<b>Nearest Surface Water(s) to Receive Runoff:</b>	_____
<b>Chapter 93 - Designated Water Use:</b>	_____
	<a href="http://www.pacode.com/secure/data/025/chapter93/chap93toc.html">http://www.pacode.com/secure/data/025/chapter93/chap93toc.html</a>
<b>Impaired according to Chapter 303(d) List?</b>	Yes <input type="checkbox"/>
	No <input type="checkbox"/>
<b>List Causes of Impairment:</b>	
<i>Is project subject to, or part of:</i>	
<b>Municipal Separate Storm Sewer System (MS4) Requirements?</b>	Yes <input type="checkbox"/>
	No <input type="checkbox"/>
<b>Existing or planned drinking water supply?</b>	Yes <input type="checkbox"/>
	No <input type="checkbox"/>
<b>If yes, distance from proposed discharge (miles):</b>	_____
<b>Approved Act 167 Plan?</b>	Yes <input type="checkbox"/>
	No <input type="checkbox"/>
	<a href="http://www.dep.state.pa.us/dep/deputate/watermgt/wc/Subjects/StormwaterManagement/GeneralPermits/default.htm">http://www.dep.state.pa.us/dep/deputate/watermgt/wc/Subjects/StormwaterManagement/GeneralPermits/default.htm</a>
<b>Existing River Conservation Plan?</b>	Yes <input type="checkbox"/>
	No <input type="checkbox"/>
	<a href="http://www.dcnr.state.pa.us/brc/rivers/riversconservation/planningprojects/">http://www.dcnr.state.pa.us/brc/rivers/riversconservation/planningprojects/</a>

**Worksheet 2. Sensitive Natural Resources**

**INSTRUCTIONS:**

1. Provide Sensitive Resources Map according to non-structural BMP 5.4.1 in Chapter 5. This map should identify wetlands, woodlands, natural drainage ways, steep slopes, and other sensitive natural areas.

2. Summarize the existing extent of each sensitive resource in the Existing Sensitive Resources Table (below, using Acres). If none present, insert 0.

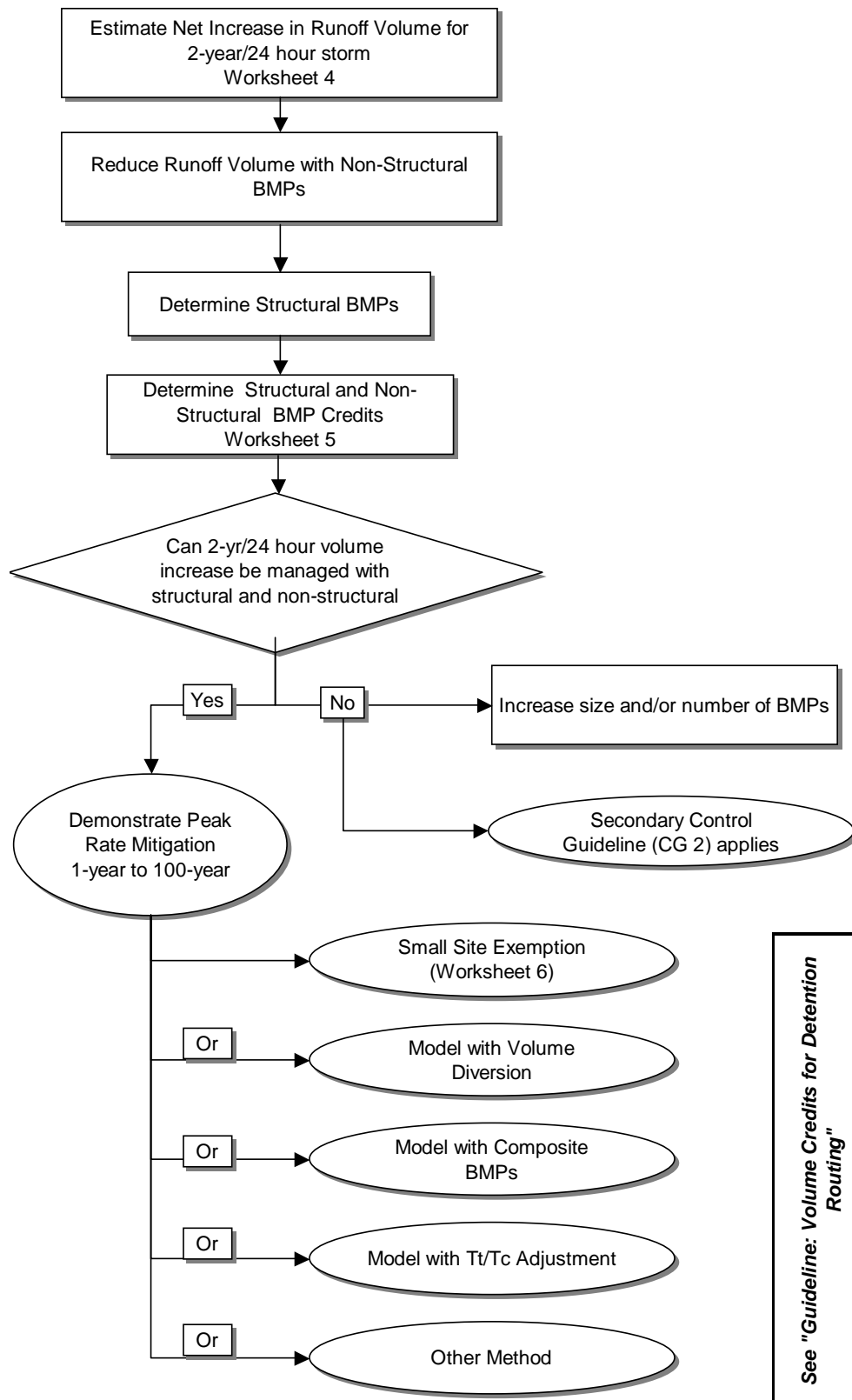
3. Summarize Total Protected Area as defined under BMPs in Chapter 5.

4. Do not count any area twice. For example, an area that is both a floodplain and a wetland may only be considered once.

<b>EXISTING NATURAL SENSITIVE RESOURCE</b>	<b>MAPPED? yes/no/n/a</b>	<b>TOTAL AREA (Ac.)</b>	<b>PROTECTED AREA (Ac.)</b>
Waterbodies			
Floodplains			
Riparian Areas			
Wetlands			
Woodlands			
Natural Drainage Ways			
Steep Slopes, 15% - 25%			
Steep Slopes, over 25%			
Other:			
Other:			
<b>TOTAL EXISTING:</b>			

Worksheet 3. Nonstructural BMP Credits																		
PROTECTED AREA																		
1.1 Area of Protected Sensitive/Special Value Features (see WS 2)			_____ Ac.															
1.2 Area of Riparian Forest Buffer Protection			_____ Ac.															
3.1 Area of Minimum Disturbance/Reduced Grading			_____ Ac.															
<b>TOTAL</b>			_____ Ac.															
<table style="margin: auto; border: 1px solid black; padding: 10px;"> <tr> <td style="text-align: center; padding: 5px;">Site Area</td> <td style="padding: 5px;"><i>minus</i></td> <td style="text-align: center; padding: 5px;">Protected Area</td> <td style="padding: 5px;">=</td> <td style="text-align: center; padding: 5px;">Stormwater Management Area</td> </tr> <tr> <td style="text-align: center; padding: 5px;"><input style="width: 100px; height: 20px;" type="text"/></td> <td style="text-align: center; padding: 5px;">-</td> <td style="text-align: center; padding: 5px;"><input style="width: 100px; height: 20px;" type="text"/></td> <td style="text-align: center; padding: 5px;">=</td> <td style="text-align: center; padding: 5px;"><input style="width: 200px; height: 20px;" type="text"/></td> </tr> <tr> <td colspan="4"></td> <td style="padding: 5px;"> <i>This is the area that requires stormwater management</i> </td> </tr> </table>				Site Area	<i>minus</i>	Protected Area	=	Stormwater Management Area	<input style="width: 100px; height: 20px;" type="text"/>	-	<input style="width: 100px; height: 20px;" type="text"/>	=	<input style="width: 200px; height: 20px;" type="text"/>					<i>This is the area that requires stormwater management</i>
Site Area	<i>minus</i>	Protected Area	=	Stormwater Management Area														
<input style="width: 100px; height: 20px;" type="text"/>	-	<input style="width: 100px; height: 20px;" type="text"/>	=	<input style="width: 200px; height: 20px;" type="text"/>														
				<i>This is the area that requires stormwater management</i>														
VOLUME CREDITS																		
<b>3.1 Minimum Soil Compaction</b>																		
Lawn	_____ ft <sup>2</sup>	x 1/4" x 1/12	= _____ ft <sup>3</sup>															
Meadow	_____ ft <sup>2</sup>	x 1/3" x 1/12	= _____ ft <sup>3</sup>															
<b>3.3 Protect Existing Trees</b>																		
<i>For Trees within 100 feet of impervious area:</i>																		
Tree Canopy	_____ ft <sup>2</sup>	x 1/2" x 1/12	= _____ ft <sup>3</sup>															
_____																		
<b>5.1 Disconnect Roof Leaders to Vegetated Areas</b>																		
<i>For runoff directed to areas protected under 5.8.1 and 5.8.2</i>																		
Roof Area	_____ ft <sup>2</sup>	x 1/3" x 1/12	= _____ ft <sup>3</sup>															
<i>For all other disconnected roof areas</i>																		
Roof Area	_____ ft <sup>2</sup>	x 1/4" x 1/12	= _____ ft <sup>3</sup>															
<b>5.2 Disconnect Non-Roof impervious to Vegetated Areas</b>																		
<i>For Runoff directed to areas protected under 5.8.1 and 5.8.2</i>																		
Impervious Area	_____ ft <sup>2</sup>	x 1/3" x 1/12	= _____ ft <sup>3</sup>															
<i>For all other disconnected roof areas</i>																		
Impervious Area	_____ ft <sup>2</sup>	x 1/4" x 1/12	= _____ ft <sup>3</sup>															
<b>TOTAL NON-STRUCTURAL VOLUME CREDIT*</b>			<input style="width: 100px; height: 20px;" type="text"/> ft <sup>3</sup>															
<small>* For use on Worksheet 5</small>																		

## FLOW CHART B Control Guideline 1 Process



**WORKSHEET 4 . CHANGE IN RUNOFF VOLUME FOR 2-YR STORM EVENT**

**PROJECT:** \_\_\_\_\_

**Drainage Area:** \_\_\_\_\_

**2-Year Rainfall:** \_\_\_\_\_ in

**Total Site Area:** \_\_\_\_\_ acres

**Protected Site Area:** \_\_\_\_\_ acres

**Managed Area:** \_\_\_\_\_ acres

**Existing Conditions:**

Cover Type/Condition	Soil Type	Area (sf)	Area (ac)	CN	S	Ia (0.2*S)	Q Runoff <sup>1</sup> (in)	Runoff Volume <sup>2</sup> (ft <sup>3</sup> )
Woodland								
Meadow								
Impervious								
<b>TOTAL:</b>								

**Developed Conditions:**

Cover Type/Condition	Soil Type	Area (sf)	Area (ac)	CN	S	Ia (0.2*S)	Q Runoff <sup>1</sup> (in)	Runoff Volume <sup>2</sup> (ft <sup>3</sup> )
<b>TOTAL:</b>								

**2-Year Volume Increase (ft3):** \_\_\_\_\_

**2-Year Volume Increase = Developed Conditions Runoff Volume - Existing Conditions Runoff Volume**

1. Runoff (in) = Q =  $(P - 0.2S)^2 / (P + 0.8S)$  where

P = 2-Year Rainfall (in)

S =  $(1000 / CN) - 10$

2. Runoff Volume (CF) = Q x Area x 1/12

Q = Runoff (in)

Area = Land use area (sq. ft)

**Note: Runoff Volume must be calculated for EACH land use type/condition and HSGI. The use of a weighted CN value for volume calculations is not acceptable.**

## WORKSHEET 5 . STRUCTURAL BMP VOLUME CREDITS

**PROJECT:** \_\_\_\_\_  
**SUB-BASIN:** \_\_\_\_\_

**Required Control Volume (ft<sup>3</sup>) - from Worksheet 4:** \_\_\_\_\_  
**Non-structural Volume Credit (ft<sup>3</sup>) - from Worksheet 3:** - \_\_\_\_\_

**Structural Volume Reqmt (ft<sup>3</sup>)** \_\_\_\_\_  
*(Required Control Volume minus Non-structural Credit)*

	Area (ft <sup>2</sup> )	Storage Volume (ft <sup>3</sup> )
6.4.1 Porous Pavement		
6.4.2 Infiltration Basin		
6.4.3 Infiltration Bed		
6.4.4 Infiltration Trench		
6.4.5 Rain Garden/Bioretenion		
6.4.6 Dry Well / Seepage Pit		
6.4.7 Constructed Filter		
6.4.8 Vegetated Swale		
6.4.9 Vegetated Filter Strip		
6.4.10 Berm		
6.5.1 Vegetated Roof		
6.5.2 Capture and Re-use		
6.6.1 Constructed Wetlands		
6.6.2 Wet Pond / Retention Basin		
6.6.3 Dry Extended Detention Basin		
6.6.4 Water Quality Filters		
6.7.1 Riparian Buffer Restoration		
6.7.2 Landscape Restoration / Reforestation		
6.7.3 Soil Amendment		
6.8.1 Level Spreader		
6.8.2 Special Storage Areas		
<i>Other</i>		

**Total Structural Volume (ft<sup>3</sup>):** \_\_\_\_\_  
**Structural Volume Requirement (ft<sup>3</sup>):** \_\_\_\_\_  
**DIFFERENCE** \_\_\_\_\_

## WORKSHEET 6 . SMALL SITE / SMALL IMPERVIOUS AREA EXCEPTION FOR PEAK RATE MITIGATION CALCULATIONS

***The following conditions must be met for exemption from peak rate analysis for small sites under CG-1:***

\_\_\_\_\_ The 2-Year/24 Hour Runoff Volume increase must be met in BMPs designed in accordance with Manual Standards

\_\_\_\_\_ Total Site Impervious Area may not exceed **1 acre**.

\_\_\_\_\_ Maximum Development Area is **5 Acres**

\_\_\_\_\_ Maximum site impervious cover is 50%.

\_\_\_\_\_ No more than 25% Volume Control can be in Non-structural BMPs

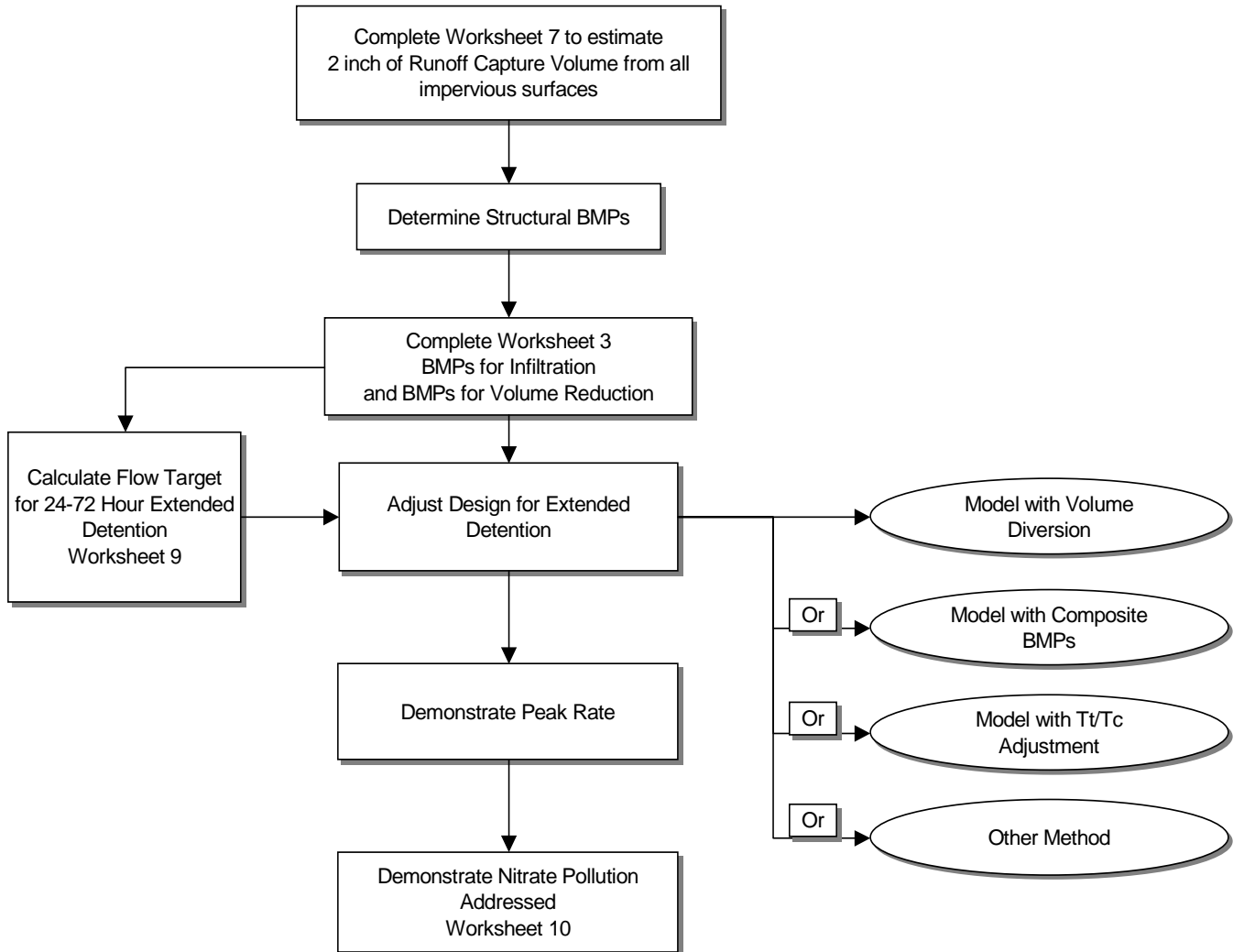
\_\_\_\_\_ Infiltration BMPs must have an infiltration of at least 0.5 in/hr.

Site Area	Percent Impervious	Total Impervious
5 acre	20%	1 acre
2 acre	50%	1 acre
1 acre	50%	0.5 acre
0.5 acre	50%	0.25 acre



# FLOW CHART C

## Control Guideline 2 Process



**WORKSHEET 7. CALCULATION OF RUNOFF VOLUMES (PRV and EDV) FOR CG-2 ONLY**

**PROJECT:** \_\_\_\_\_

**DRAINAGE AREA:**

**Total Site Area:** \_\_\_\_\_ **acres**

**Protected Site Area:** \_\_\_\_\_ **acres**

**Managed Area:** \_\_\_\_\_ **acres**

**Total Impervious Area** \_\_\_\_\_ **acres**

**2 Inch Runoff - Multiply Total Impervious Area by 2 inch**

Cover Type	Area (ac)	Runoff Capture Volume (ft <sup>3</sup> )
Roof		
Pavement		
Other Impervious		
<b>TOTAL:</b>		

**1 Inch Rainfall -**

Cover Type	Area (sf)	Area (ac)	Runoff (in)	Runoff Volumes (ft <sup>3</sup> )
<b>TOTAL:</b>				

1. Total Runoff Capture Volume (ft<sup>3</sup>) = Total Impervious Area (ft<sup>2</sup>) x 2 inch x 1/12

2. PRV (ft<sup>3</sup>) = Total Impervious Area (ft<sup>2</sup>) x 1 inch x 1/12

3. EDV (ft<sup>3</sup>) = Total Impervious Area (ft<sup>2</sup>) x 1 inch x 1/12

Water quality volume requirements for land areas with existing cover consisting of meadow, brush, wood-grass combination, or woods proposed for conversion to any other non-equivalent type of pervious cover shall be sized for one-half (1/2) the volume required for impervious surfaces as mentioned in this worksheet and calculated in items 1 through 3 above

## WORKSHEET 8 . STRUCTURAL BMP VOLUME CREDITS

**PROJECT:** \_\_\_\_\_  
**SUB-BASIN:** \_\_\_\_\_

Required Control Volume (ft<sup>3</sup>) - from Worksheet 7: \_\_\_\_\_  
 Non-structural Volume Credit (ft<sup>3</sup>) - from Worksheet 3: - \_\_\_\_\_

Structural Volume Reqmt (ft<sup>3</sup>) \_\_\_\_\_  
 (Required Control Volume minus Non-structural Credit)

	Proposed BMP*	Area (ft <sup>2</sup> )	Storage Volume (ft <sup>3</sup> )
6.4.1	Porous Pavement		
6.4.2	Infiltration Basin		
6.4.3	Infiltration Bed		
6.4.4	Infiltration Trench		
6.4.5	Rain Garden/Bioretention		
6.4.6	Dry Well / Seepage Pit		
6.4.7	Constructed Filter		
6.4.8	Vegetated Swale		
6.4.9	Vegetated Filter Strip		
6.4.10	Berm		
6.5.1	Vegetated Roof		
6.5.2	Capture and Re-use		
6.6.1	Constructed Wetlands		
6.6.2	Wet Pond / Retention Basin		
6.6.3	Dry Extended Detention Basin		
6.6.4	Water Quality Filters		
6.7.1	Riparian Buffer Restoration		
6.7.2	Landscape Restoration / Reforestation		
6.7.3	Soil Amendment		
6.8.1	Level Spreader		
6.8.2	Special Storage Areas		
	<i>Other</i>		

Total Structural Volume (ft<sup>3</sup>): \_\_\_\_\_  
 Structural Volume Requirement (ft<sup>3</sup>): \_\_\_\_\_

DIFFERENCE \_\_\_\_\_

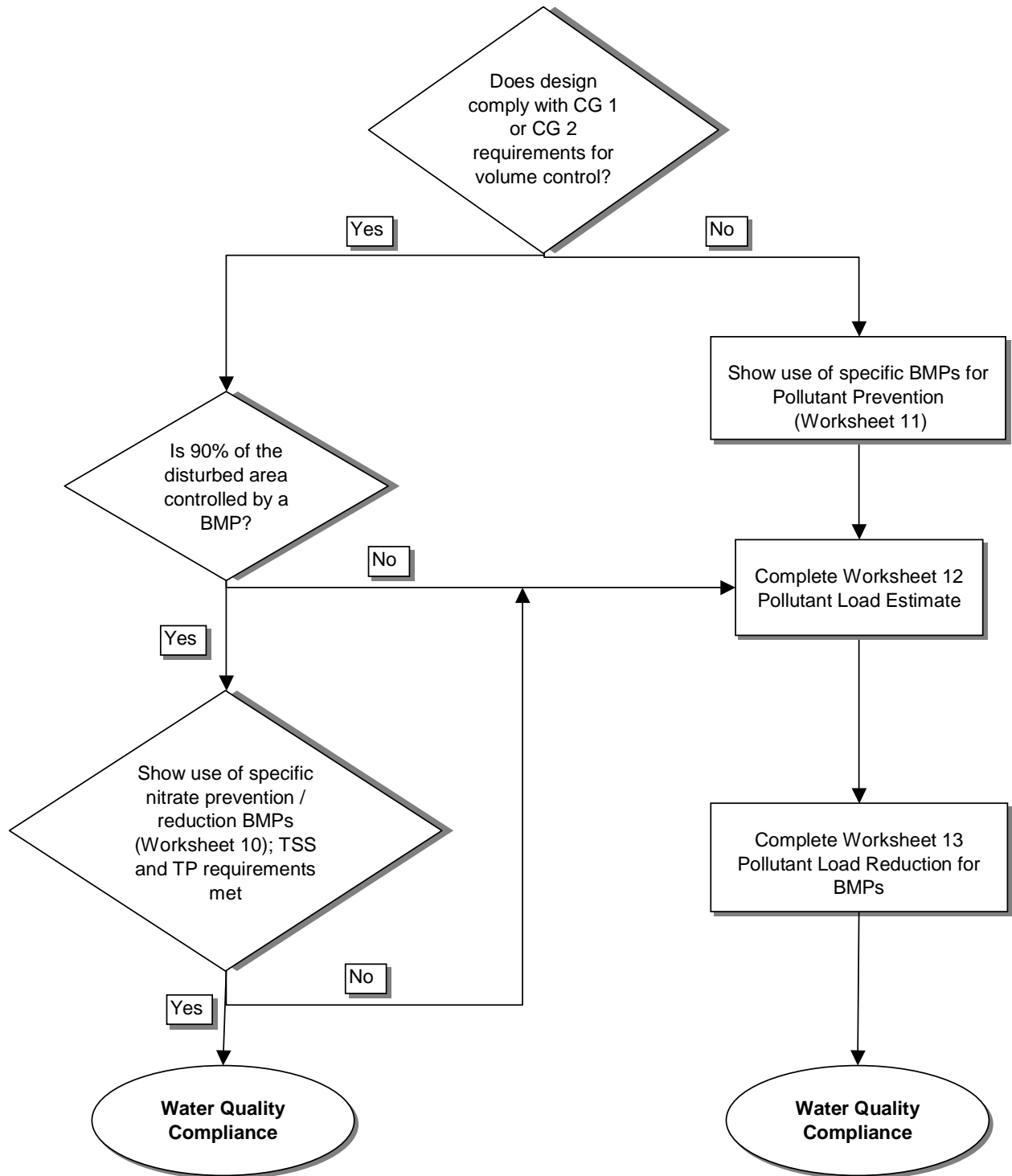
**1) Volume Diversion.** Many computer models have components that allow a "diversion" or "abstraction". The total volume reduction provided by the applicable structural and non-structural BMPs can be diverted or abstracted from the modeled runoff before it is routed to the detention system(s). This approach is very conservative because it does not give any credit to the increased time of travel, ongoing infiltration, etc. associated with the BMPs.

**2) Composite BMPs.** For optimal stormwater management, this manual suggests widely distributed BMPs for volume, rate, and quality control. This approach, however, can be very cumbersome to evaluate in detail with common computer models. To facilitate modeling, similar types of BMPs can be combined within the model. For modeling purposes, the storage of the combined BMP is simply the sum of the BMP capacities that it represents. A stage-storage-discharge relationship can be developed for the combined BMP based on the configuration of the individual systems. The combined BMPs can then be routed normally and the results submitted.

**3) Travel Time/ Time of Concentration Adjustment.** The use of widely-distributed, volume-reducing BMPs can significantly increase the post-development runoff travel time and therefore decrease the peak rate of discharge. The Delaware Urban Runoff Management Model (DURMM) calculates the extended travel time through storage elements, even at flooded depths, to adjust peak flow rates (Lucas, 2001). The extended travel time is essentially the residence time of the storage elements, found by dividing the total storage by the 2-year peak flow rate. This increased travel time can be added to the time of concentration of the area to account for the slowing effect of the volume-reducing BMPs. This can reduce the amount of detention storage required for peak rate control.

**4) Other Methods.** Other methods, such as adjusting runoff curve numbers based on the runoff volume left after BMP application, or reducing net precipitation based on the volume captured, can be applied as appropriate.

### Flow Chart D Water Quality Process



**WORKSHEET 10. WATER QUALITY COMPLIANCE FOR NITRATE**

*Does the site design incorporate the following BMPs to address nitrate pollution? A summary "yes" rating is achieved if at least 2 Primary BMPs for nitrate are provided across the site or 4 secondary BMPs for nitrate are provided across the site (or the*

**PRIMARY BMPs FOR NITRATE:**

	YES	NO
NS BMP 5.4.2 - Protect / Conserve / Enhance Riparian Buffers	<input type="checkbox"/>	<input type="checkbox"/>
NS BMP 5.5.4 - Cluster Uses at Each Site	<input type="checkbox"/>	<input type="checkbox"/>
NS BMP 5.6.1 - Minimize Total Disturbed Area	<input type="checkbox"/>	<input type="checkbox"/>
NS BMP 5.6.3 - Re-Vegetate / Re-Forest Disturbed Areas (Native Species)	<input type="checkbox"/>	<input type="checkbox"/>
NS BMP 5.9.1 - Street Sweeping / Vacuuming	<input type="checkbox"/>	<input type="checkbox"/>
Structural BMP 6.7.1 - Riparian Buffer Restoration	<input type="checkbox"/>	<input type="checkbox"/>
Structural BMP 6.7.2 - Landscape Restoration	<input type="checkbox"/>	<input type="checkbox"/>

**SECONDARY BMPs FOR NITRATE:**

NS BMP 5.4.1 - Protect Sensitive / Special Value Features	<input type="checkbox"/>	<input type="checkbox"/>
NS BMP 5.4.3 - Protect / Utilize Natural Drainage Features	<input type="checkbox"/>	<input type="checkbox"/>
NS BMP 5.6.2 - Minimize Soil Compaction	<input type="checkbox"/>	<input type="checkbox"/>
Structural BMP 6.4.5 - Rain Garden / Bioretention	<input type="checkbox"/>	<input type="checkbox"/>
Structural BMP 6.4.8 - Vegetated Swale	<input type="checkbox"/>	<input type="checkbox"/>
Structural BMP 6.4.9 - Vegetated Filter Strip	<input type="checkbox"/>	<input type="checkbox"/>
Structural BMP 6.6.1 - Constructed Wetland	<input type="checkbox"/>	<input type="checkbox"/>
Structural BMP 6.7.1 - Riparian Buffer Restoration	<input type="checkbox"/>	<input type="checkbox"/>
Structural BMP 6.7.2 - Landscape Restoration	<input type="checkbox"/>	<input type="checkbox"/>
Structural BMP 6.7.3 - Soils Amendment/Restoration	<input type="checkbox"/>	<input type="checkbox"/>

## WORKSHEET 11. BMPS FOR POLLUTION PREVENTION

*Does the site design incorporate the following BMPs to address nitrate pollution? A summary "yes" rating is achieved if at least 2 BMPs are provided across the site. "Provided across the site" is taken to mean that the specifications for that BMP set forward in Chapters 5 and 6 are satisfied.*

**BMPs FOR POLLUTANT PREVENTION:**

	YES	NO
NS BMP 5.4.1 - Protect Sensitive / Special Value Features	<input type="checkbox"/>	<input type="checkbox"/>
NS BMP 5.4.2 - Protect / Conserve / Enhance Riparian Buffers	<input type="checkbox"/>	<input type="checkbox"/>
NS BMP 5.4.3 - Protect / Utilize Natural Flow Pathways in Overall Stormwater Planning and Design	<input type="checkbox"/>	<input type="checkbox"/>
NS BMP 5.5.1 - Cluster Uses at Each Site; Build on the Smallest Area Possible	<input type="checkbox"/>	<input type="checkbox"/>
NS BMP 5.6.1 - Minimize Total Disturbed Area - Grading	<input type="checkbox"/>	<input type="checkbox"/>
NS BMP 5.6.2 - Minimize Soil Compaction in Disturbed Areas	<input type="checkbox"/>	<input type="checkbox"/>
NS BMP 5.6.3 - Re-Vegetate / Re-Forest Disturbed Areas (Native Species)	<input type="checkbox"/>	<input type="checkbox"/>
NS BMP 5.7.1 - Reduce Street Imperviousness	<input type="checkbox"/>	<input type="checkbox"/>
NS BMP 5.7.2 - Reduce Parking Imperviousness	<input type="checkbox"/>	<input type="checkbox"/>
NS BMP 5.8.1 - Rooftop Disconnection	<input type="checkbox"/>	<input type="checkbox"/>
NS BMP 5.8.2 - Disconnection from Storm Sewers	<input type="checkbox"/>	<input type="checkbox"/>
NS BMP 5.9.1 - Street Sweeping	<input type="checkbox"/>	<input type="checkbox"/>
Structural BMP 6.7.1 - Riparian Buffer Restoration	<input type="checkbox"/>	<input type="checkbox"/>
Structural BMP 6.7.2- Landscape Restoration	<input type="checkbox"/>	<input type="checkbox"/>
Structural BMP 6.7.3- Soils Amendment and Restoration	<input type="checkbox"/>	<input type="checkbox"/>

**WORKSHEET 12. WATER QUALITY ANALYSIS OF POLLUTANT LOADING FROM ALL DISTURBED AREAS**

TOTAL SITE AREA (AC)	
TOTAL DISTURBED AREA (AC)	
DISTURBED AREA CONTROLLED BY BMPs (AC)	

TOTAL DISTURBED AREAS:

	LAND COVER CLASSIFICATION	POLLUTANT			COVER (Acres)	RUNOFF VOLUME (AF)	POLLUTANT LOAD		
		TSS EMC (mg/l)	TP EMC (mg/l)	Nitrate-Nitrite EMC (mg/l as N)			TSS** (LBS)	TP** (LBS)	NO <sub>3</sub> (LBS)
Pervious Surfaces	Forest	39	0.15	0.17					
	Meadow	47	0.19	0.3					
	Fertilized Planting Area	55	1.34	0.73					
	Native Planting Area	55	0.40	0.33					
	Lawn, Low-Input	180	0.40	0.44					
	Lawn, High-Input	180	2.22	1.46					
	Golf Course Fairway/Green	305	1.07	1.84					
	Grassed Athletic Field	200	1.07	1.01					
Impervious Surfaces	Rooftop	21	0.13	0.32					
	High Traffic Street / Highway	261	0.40	0.83					
	Medium Traffic Street	113	0.33	0.58					
	Low Traffic / Residential Street	86	0.36	0.47					
	Res. Driveway, Play Courts, etc.	60	0.46	0.47					
	High Traffic Parking Lot	120	0.39	0.60					
	Low Traffic Parking Lot	58	0.15	0.39					
<b>TOTAL LOAD</b>									
<b>REQUIRED REDUCTION (%)</b>							<b>85%</b>	<b>85%</b>	<b>50%</b>
<b>REQUIRED REDUCTION (LBS)</b>									

\* Pollutant Load = [EMC, mg/l] X [Volume, AF] X [2.7, Unit Conversion]

\*\* TSS and TP calculations only required for projects not meeting CG1/CG2 or not controlling less than 90% of the disturbed area



**WORKSHEET 13. POLLUTANT REDUCTION THROUGH BMP APPLICATIONS\***

\* FILL THIS WORKSHEET OUT FOR EACH BMP TYPE WITH DIFFERENT POLLUTANT REMOVAL EFFICIENCIES. SUM POLLUTANT REDUCTION ACHIEVED FOR ALL BMP TYPES ON FINAL SHEET.

BMP TYPE: \_\_\_\_\_

DISTURBED AREA CONTROLLED BY THIS BMP TYPE (AC)	
---	--

DISTURBED AREAS CONTROLLED BY THIS BMP TYPE:

	LAND COVER CLASSIFICATION	POLLUTANT			COVER (Acres)	RUNOFF VOLUME (AF)	POLLUTANT LOAD**		
		TSS EMC (mg/l)	TP EMC (mg/l)	Nitrate-Nitrite EMC (mg/l as N)			TSS*** (LBS)	TP*** (LBS)	NO <sub>3</sub> (LBS)
Pervious Surfaces	Forest	39	0.15	0.17					
	Meadow	47	0.19	0.3					
	Fertilized Planting Area	55	1.34	0.73					
	Native Planting Area	55	0.40	0.33					
	Lawn, Low-Input	180	0.40	0.44					
	Lawn, High-Input	180	2.22	1.46					
	Golf Course Fairway/Green	305	1.07	1.84					
Grassed Athletic Field	200	1.07	1.01						
Impervious Surfaces	Rooftop	21	0.13	0.32					
	High Traffic Street / Highway	261	0.40	0.83					
	Medium Traffic Street	113	0.33	0.58					
	Low Traffic / Residential Street	86	0.36	0.47					
	Res. Driveway, Play Courts, etc.	60	0.46	0.47					
	High Traffic Parking Lot	120	0.39	0.60					
	Low Traffic Parking Lot	58	0.15	0.39					
<b>TOTAL LOAD TO THIS BMP TYPE</b>									
<b>POLLUTANT REMOVAL EFFICIENCIES FROM TABLE 9-3 (%)</b>									
<b>POLLUTANT REDUCTION ACHIEVED BY THIS BMP TYPE (LBS)</b>									

<b>POLLUTANT REDUCTION ACHIEVED BY ALL BMP TYPES (LBS)</b>			
<b>REQUIRED REDUCTION FROM WS12 (LBS)</b>			

\*\* Pollutant Load = [EMC, mg/l] X [Volume, AF] X [2.7, Unit Conversion]

\*\*\* TSS and TP calculations only required for projects not meeting CG1/CG2 or not controlling less than 90% of the disturbed area

## 8.9 References and Additional Information Sources

- Bonnin, G., Todd, D., Lin, B., Parzybok, T., Yekta, M., and Riley, D., 2003. *NOAA Atlas 14, Precipitation-Frequency Atlas of the United States*, Volume 1. National Weather Service, National Oceanic and Atmospheric Administration, Silver Spring, Md.
- Claytor, R.A. and Schuler, T.R., 1996. *Design of Stormwater Filtering Systems*, Center for Watershed Protection, Silver Spring, MD
- Green, W.H. and Ampt, G.A., 1911. "Studies on Soil Physics, 1. The Flow of Air and Water Through Soils," *Journal of Agricultural Sciences*, Vol. 4, pp. 1124.
- Horton, R.E., 1940. *An Approach toward a Physical Interpretation of Infiltration Capacity*. Soil Science Society of America, Proceedings 4:399-417.
- James, W., Huber W., Dickinson, R., Pitt, R., James, W.R., Roesner, L., and Aldrich, J., 2003. *User's Guide to SWMM*. Computational Hydraulics International, Guelph, Canada.
- Linsley, R., Franzini, J., Freyberg, D., and Tchobanoglous, G., 1992. *Water-Resources Engineering*. 4<sup>th</sup> ed. Irwin McGraw-Hill, New York, NY.
- Mein, R.G. and Larson, C.L., 1973. "Modeling Infiltration During a Steady Rain," *Water Resources Research*, Vol. 9, No. 2, pp. 334-394.
- National Resources Conservation Service. *National Engineering Handbook*. Part 630: Hydrology, 1969-2001. Originally published as the *National Engineering Handbook*, Section 4: Hydrology. Available online at: <http://www.wcc.nrcs.usda.gov/hydro/hydro-techref-neh-630.html>.
- National Resources Conservation Service, 2004. National Water and Climate Center "Hydraulics and Hydrology – Tools and Models" Website, U.S. Department of Agriculture. Available online at: <http://www.wcc.nrcs.usda.gov/hydro/hydro-tools-models.html>.
- National Weather Service, Hydrometeorological Design Studies Center, 2004. "Current Precipitation Frequency Information and Publications" Website, National Oceanic and Atmospheric Administration. Available online at: <http://www.nws.noaa.gov/ohd/hdsc/currentpf.htm>.
- New Jersey Department of Environmental Protection, 2004. *New Jersey Stormwater Best Management Practices Manual*.
- Pitt, R., 2003. *The Source Loading and Management Model (WinSLAMM): Introduction and Basic Uses*. Available online at: <http://unix.eng.ua.edu/~rpitt/SLAMMDETPOND/WinSlamm/Ch1/M1.html#Introduction#Introduction>.
- Pitt, R. and Voorhees, J., 2000. *The Source Loading and Management Model (SLAMM): A Water Quality Management Planning Model for Urban Stormwater Runoff*." Available online at: [http://unix.eng.ua.edu/~rpitt/SLAMMDETPOND/WinSlamm/MainWINSLAMM\\_book.html](http://unix.eng.ua.edu/~rpitt/SLAMMDETPOND/WinSlamm/MainWINSLAMM_book.html).

- Reese, S. and Lee, J., 1998. Summary of Groundwater Quality Monitoring Data (1985 - 1997) from Pennsylvania's Ambient and Fixed Station Network (FSN) Monitoring Program: Selected Groundwater Basins in Southwestern, Southcentral and Southeastern Pennsylvania, Bureau of Water Supply Management, PADEP.
- Rossmann, L., 2004. *Storm Water Management Model User's Manual, Version 5.0*. National Risk Management Research Laboratory, U.S. Environmental Protection Agency, Cincinnati, OH. Available online at: <http://www.epa.gov/ednrmrl/swmm/#A>.
- Soil Conservation Service, 1986. *Urban Hydrology for Small Watersheds*. 2<sup>nd</sup> ed. Technical Release 55, U.S. Department of Agriculture. Available online at: <http://www.wcc.nrcs.usda.gov/hydro/hydro-tools-models-tr55.html>.
- Soil Conservation Service, 1992. TR-20 Computer Program for Project Formulation Hydrology.
- U.S. Army Corp of Engineers, 2001. *Hydrologic Modeling System (HEC-HMS) User's Manual*. Version 2.1. Davis, CA.
- U.S. Environmental Protection Agency, 2004. *Storm Water Management Model (SWMM) Version 5.0.003* Website. Available online at: <http://www.epa.gov/ednrmrl/swmm/#A>.
- Viessman, W. and Lewis G, 2003. *Introduction to Hydrology*. 5<sup>th</sup> ed. Pearson Education, Inc., Upper Saddle River, NJ.
- Woodward, D.E., Hawkins, R.H., Jiang, R., Hjelmfelt, A.T., Van Mullem, J.A., and Quan, D.Q., 2003. "Runoff Curve Number Method: Examination of the Initial Abstraction Ratio," *World Water & Environmental Resources Congress, 2003: Proceeding of the Congress: June 23-26, 2003, Philadelphia, PA*.



---

# **Pennsylvania Stormwater Best Management Practices Manual**

---

## **Chapter 9**

### **Case Studies: Innovative Stormwater Management Approaches and Practices**





## **Chapter 9 Case Studies: Innovative Stormwater Management Approaches and Practices**

<b>9.1</b>	<b>Introduction.....</b>	<b>1</b>
<b>9.2</b>	<b>Outline of Information Needed for Case Studies.....</b>	<b>2</b>
<b>9.3</b>	<b>Case Studies.....</b>	<b>3</b>
	<b>1: Penn State University - Centre County Visitor Center, Centre County...3</b>	
	<b>2: Dennis Creek Streambank Restoration, Franklin County.....10</b>	
	<b>3: Commerce Plaza III, Lehigh County.....11</b>	
	<b>4: Flying J. Truck Plaza for Welsh Oil of Indiana.....13</b>	
	<b>5: Ephrata Performing Arts Center, Lancaster County.....16</b>	
	<b>6: Lebanon Valley Agricultural Center, Lebanon County.....18</b>	
	<b>7: Penn State University Berks County Campus, Berks County.....19</b>	
	<b>8: Warm Season Meadows at Williams Transco, Chester County.....22</b>	
	<b>9: Hills of Sullivan Residential Subdivision, Chester County.....24</b>	
	<b>10: Applebrook Golf Course Community, Chester County.....28</b>	
	<b>11: Swan Lake Drive Development, Delaware County.....30</b>	





## Case Studies: Innovative Stormwater Management Approaches and Practices

### 9.1 Introduction

Although examples of BMPs have been included throughout all chapters of this manual with a considerable number of illustrations, in most cases these examples have been necessarily condensed and highly summarized. Most examples have not been able to do justice to all aspects of the site development program and the site design and stormwater management plans that have been developed. Consequently, early in the process of developing this new manual, the decision was made to include a chapter that highlights functioning projects in Pennsylvania communities that have successfully incorporated many of the Non-Structural and Structural BMPs that are described in this manual. Clearly, seeing is believing – there is great value in being able to visit and view firsthand successful applications of the many different BMPs which have been presented.

This chapter is a work in progress, where PADEP hopes to increase its file of successful case studies over time. In particular, the hope is to add many more successful applications from all regions of the state. Many of the innovative projects that have been undertaken have occurred in projects in southeastern and southcentral Pennsylvania, to some extent reflecting the greater amount of land development activity occurring in that region of Pennsylvania.

A Self-Guided Stormwater Best Management Practices Tour has been developed recently by the Chester County Conservation District and funded by the PADEP Growing Greener Grant Program. The Tour ingeniously features 21 different sites that include a variety of both non-structural and structural BMPs applied in residential, commercial, and recreational land use settings. The entire Tour and all of the written and photographic material which describes the sites and stormwater practices is available on line through the Chester County Conservation District website. Several of the BMPs included in the tour are featured in this chapter. Many other County Conservation Districts have also installed demonstration BMPs at their office locations, including Westmoreland, Adams, Dauphin and Erie Counties.

The case studies that have been included in this chapter are designed to focus on successful BMP application - what works. Over time, this case study discussion will be expanded to include lists of what to avoid – what doesn't work – as well. PADEP invites all interested stormwater stakeholders to submit case study information in the future for additional projects. Section 9.2 is a list of information and data items that case study descriptions should address, although it is recognized that some data gaps may exist.

## 9.2 Outline of Information Needed for Case Studies

### PADEP Stormwater Manual Case Study

#### Outline of Needed Information/Data

Name of Project:

Address of Project:

Street

Municipal/county

Year constructed

Developer/builder/owner (name and contact information, if available)

Natural Site Features:

Water Resources

Major Watershed/minor watershed

Stream classification

Special: water supply source? TMDL? Impaired streams?

Streams, ponds, lakes?

Drainage features on the site

Wetlands? Floodplains? Riparian areas?

Wells (existing and future)? Zone of contribution? Zone of influence? Groundwater protected area?

Geology

Rock/aquifer type?

Special? Limestone? Subsidence potential? Fracture/fault traces? Lineaments?

Soils Hydrologic Soil Group A thru D?

Soil testing performed?

Thickness?

Other?

Slopes?

Vegetation

Existing at site?

Extent of vegetation disturbed/removed?

Re-vegetation?

Proposed Use/Building Program

How much?

Of what?

Total site area?

Total disturbed area?

Total impervious area?

Costs of development?

Proposed Stormwater BMPs

Structurals?

Design specs, calculations, etc.

Non-Structurals?

Design specs, calculations, etc.

Maintenance issues?

Other special issues?

Costs of site work and stormwater elements?

### 9.3 Case Studies

The following case studies present examples of a range of structural and nonstructural BMPs that have been successfully implemented across the state. The information provided has been assembled from contributing Conservation Districts within Pennsylvania. Each case study has been developed to include a high level of detail from the information provided, however data gaps do exist. For further information, the reader is encouraged to contact the conservation district in the county where the project is located.

#### Case Study 1: Penn State University - Centre County Visitor Center, Centre County

- Porous Asphalt Parking Lots underlain with Subsurface Infiltration Beds
- Porous Concrete Sidewalks
- Subsurface Infiltration Trenches
- Vegetated Infiltration Bed
- Several Rain Gardens / Bioretention areas

#### Project Background

The Penn State University/Centre County Visitor Center in State College was constructed in 1999 on a site underlain by the Nittany Formation. The Visitor's Center incorporates a number of stormwater infiltration techniques, shown in Figure 9-1, and was designed to imitate the natural hydrologic system that existed at the site before development.

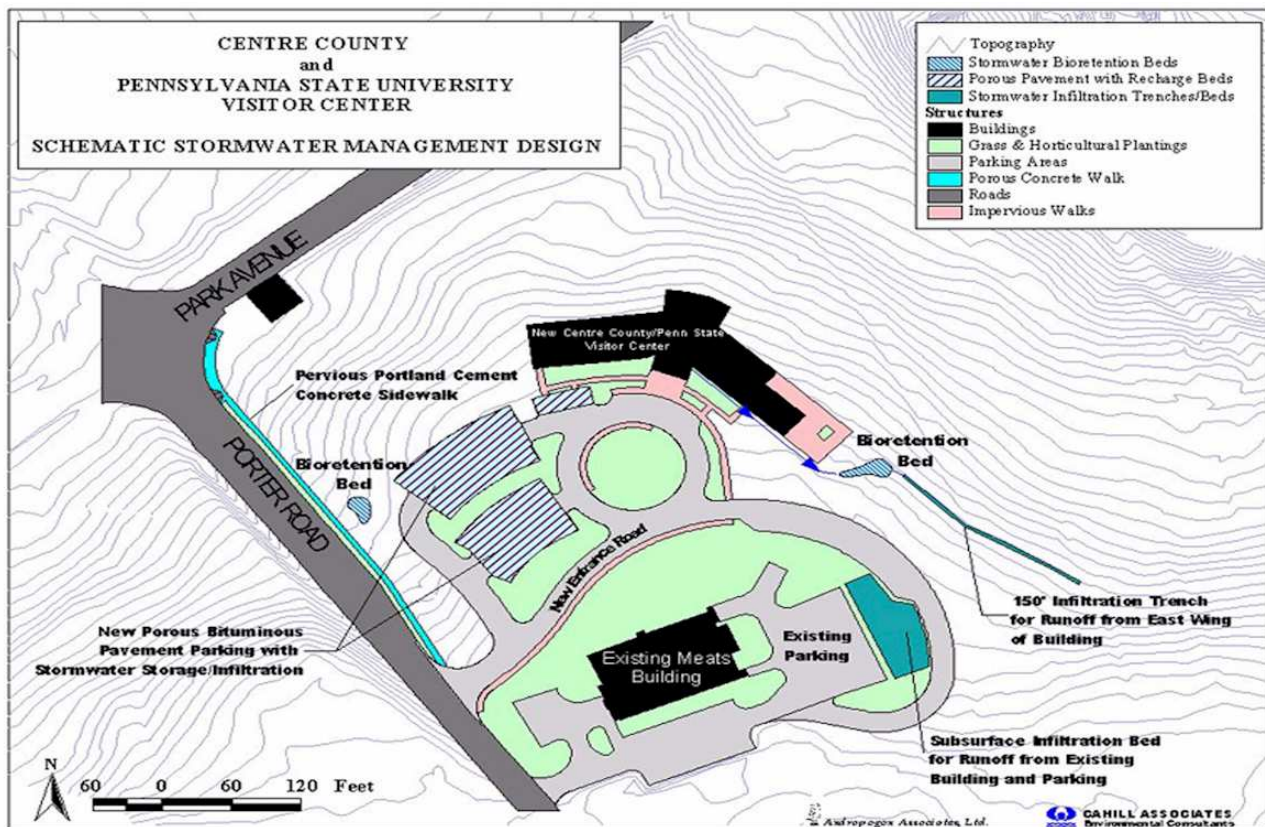


Figure 9-1. Stormwater Management System at PSU Visitor's Center in Centre County, PA.

According to the soil survey, the soil at this site was classified as the Hagerstown Series, well-drained soils that formed in limestone residuum. Typically, the surface layer was dark-brown silt loam about eight (8) inches thick. The subsoil consisted of yellowish-red and reddish-brown silty clay, clay, and silty-clay loam approximately 37 inches thick. The substratum was generally yellowish-brown clay loam to a depth of about 75 inches. The entire 5-acre site was underlain by the same soil series.

This information indicated several important characteristics of this site, even before detailed testing was completed. The soil was well-drained with probably at least 5 to 6 feet of soil above the weathered bedrock. Some clay was contained in the soils, which was a positive element since some mix of clay would prevent water from draining excessively rapidly and would serve to remove pollutants.

The underlying geology was classified as the Nittany Formation according to the Department of Environmental Resources, Bureau of Topographic and Geologic Survey (1982). This formation consists of light to dark gray, finely to coarsely crystalline dolomite with alternating beds of sandy, cherty dolomite. The rock is moderately resistant to weathering and is slightly weathered to a shallow depth. The development of joint and solution channel openings in the rock is common. Bedrock pinnacles are also common in the interface between the rock and soil mantle, which can make excavation of the rock difficult. No specific geologic features (i.e. fracture traces) are indicated for this site.

Again, this information was crucial to developing a more detailed site investigation program. The presence of pinnacles required a field investigation that can provide a site-specific understanding of the pinnacle locations. In addition, the tendency for joint and solution channel openings to form indicates a strong need to disperse stormwater and avoid concentrated points of storage or infiltration.

One additional piece of important information is that several University water supply wells are located approximately 1/2-mile downstream of this site, indicating the importance of maintaining groundwater recharge and water quality.

### **Site Testing: Geotechnical Investigation for Building Structure**

The initial field investigation involved the excavation of five test borings, two groundwater-monitoring wells, and four test pits. The initial tests were all installed as part of the geotechnical investigation for the proposed building (independent of SWM), but provided useful and valid information for the stormwater system as well. In other words, the stormwater design engineer should make use of all available data developed at the site.

This information included the following findings:

Groundwater was not encountered in any of the borings or test pits.

Auger refusals were encountered at depths ranging from 2 feet to 8.7 feet – very shallow.

Refusal materials were encountered in three of the four test pits ranging from 3.1 to 4.8 feet.

The dolomitic limestone rock cores were weathered and fractured near the surface.

The rock contained interbedded clay seams.

No evidence of subsurface activity associated with sinkholes was encountered.

### **Site Testing: Geotechnical Investigation for Stormwater Management**

The information from the building geotechnical investigation confirmed that bedrock depth was variable and could be quite shallow. Based on this information, a more detailed geotechnical investigation was developed that included a grid of shallow core borings, to a depth of ten feet or refusal, approximately 25 feet on-center. The shallow augers confirmed that there was considerable variation in the top of rock reflecting the pinnacle nature of the underlying bedrock.

Seven additional test pits were also excavated at the same time that the borings were undertaken. These test pits were a critical part of the investigation and provided direct physical observation of the soil layers and geology, confirming the soil survey series designations (which may or may not be correct for the site). In this situation the test pits indicated the considerable variability in the top of rock; even within a distance of eight feet (the length of the test pit), the surface of the bedrock could vary by two to three feet. At the same time, simple percolation tests were also conducted at the test pits to provide an estimate of the infiltration capabilities of the soil.

### **Compilation of Data: Cross Section Development**

Before any design of the site and stormwater system takes place, the engineer should understand the data in relation to the proposed use of the site. The most effective way to understand this information is to incorporate it into the site plans. The location of the test borings and test pits is indicated on Figure 9-2, which also indicates the proposed site layout. Next to each test boring, the depth to bedrock is indicated. This is the first step in laying out the stormwater components. The engineer should strive to integrate the information on a single sheet that helps the engineer visualize and determine feasible areas for infiltration systems. At the Penn State Visitor Center, the area of the parking lots had been generally proposed. The next step in design was to develop a profile of this information. Several cross sections of the site were developed in the area of the proposed parking lots. On each profile, the existing surface topography, the depth to bedrock and any other relevant information was plotted.

### **Stormwater Management Design: Fit to Site and Close to Source**

Using these profiles, the parking bays and infiltration beds were “fit” into the hillside, stepping down the hillside with two parking bays, and adjusting the bottoms of the infiltration beds to “step down” as well. This is shown in Figure 9-3.

Several items in design should be noted. Because the rock was shallow in places, the existing soil was not excavated. Instead, the beds were “built up” using berms to avoid soil excavation, and only the organic layer was removed. Where rock was very shallow, infiltration was limited to what would naturally fall or drain to the area before development, and no attempt was made to convey additional stormwater to the area. Instead, the pre-development balance (or Loading Rate) was carefully maintained.

Development of cross sections can be an extremely useful element in design of infiltration systems on carbonate rock. Because the beds must be carefully set with adequate soil mantle, the cross sections provide the design engineer with the information necessary for the layout. Additionally, cross sections provide the Contractor with the necessary information to build the system. In the same manner that profiles are required for utility pipe design (i.e., water, wastewater, and stormwater pipes), profiles are an important component of design of infiltration BMPs in carbonate rock.

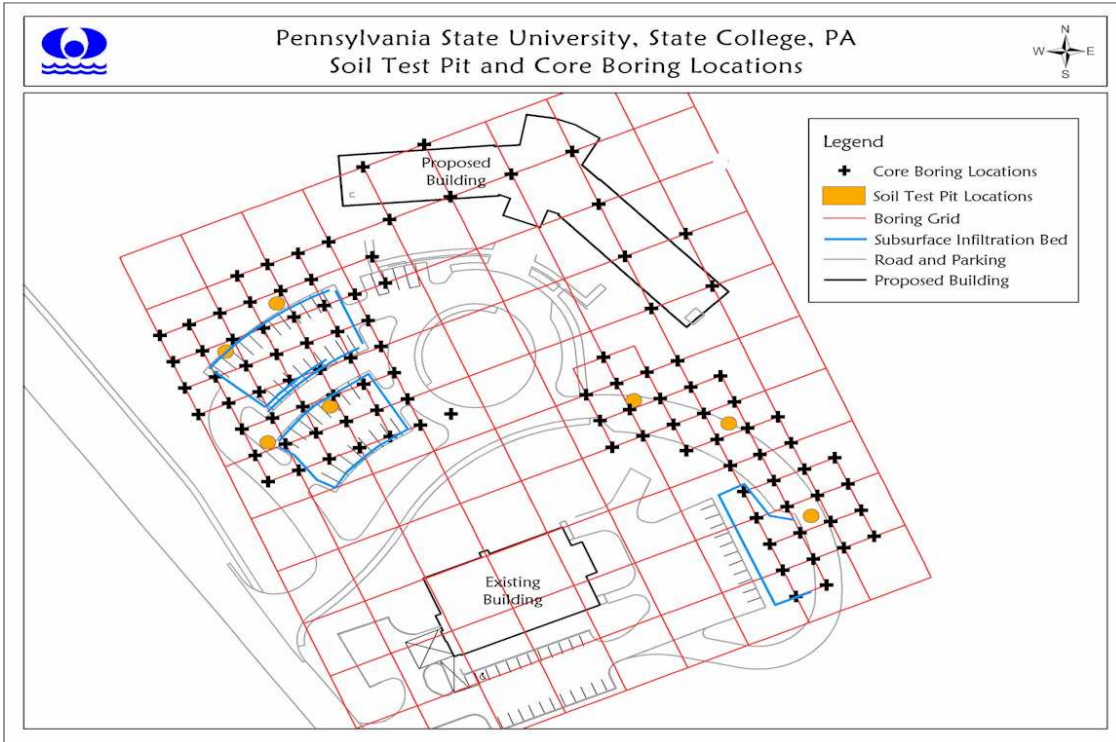


Figure 9-2. Core Boring and Soil Test Pit Locations at the PSU Visitor's Center, Centre County.

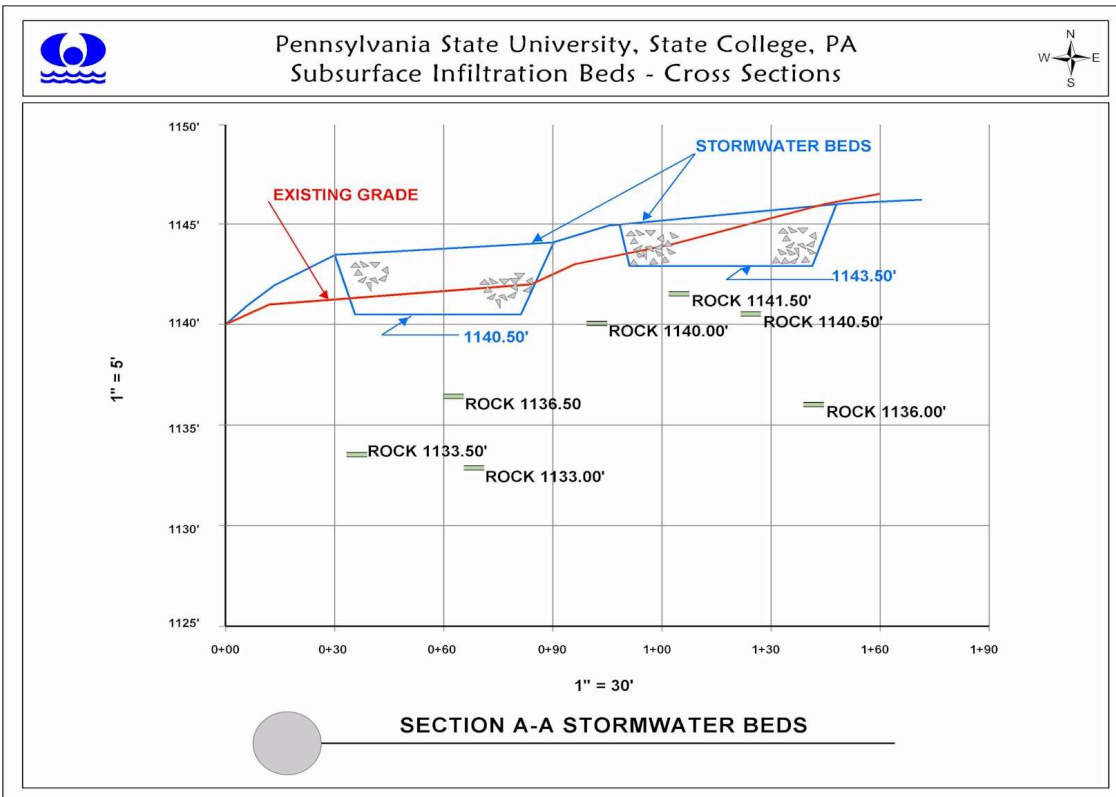


Figure 9-3. Cross-section view showing bedrock pinnacles, existing grade, and proposed stormwater infiltration beds with elevations.

Finally, and most importantly, it was recognized at the Visitor Center that any attempt to convey stormwater from one portion of the site to another would result in stormwater pipes that would be placed in the bedrock. Given the pinnacled nature of the site, it would be inevitable that any length of pipe would be forced to traverse bedrock. To avoid this situation, stormwater is managed as close to the source as possible and a variety of measures are incorporated:

Runoff from the roof of the eastern side of the building is conveyed to a Rain Garden and then to a subsurface Infiltration Trench located on contour.

The Infiltration Trench (Figure 9-4) intercepts a portion of the entrance road runoff. To compensate for the remainder, a vegetated subsurface Infiltration Bed (Figure 9-5) was located immediately adjacent to an existing, uncontrolled parking lot.

The runoff from the western portion of the building is conveyed to the parking lot immediately adjacent to the building where the soil mantle is suitable and the top of bedrock was much deeper (Figure 9-6). In several key locations where stormwater management was needed, small Rain Gardens (Figure 9-7), designed to infiltrate, were incorporated to avoid installing stormwater pipes.

Porous concrete sidewalks were constructed to manage the rainfall incident to them (Figure 9-8).



*Figure 9-4. Infiltration trench located on contour, State College, Centre County.*



*Figure 9-5. Vegetated infiltration bed, State College, Centre County.*



*Figure 9-6. Porous asphalt parking lot, State College, Centre County.*



*Figure 9-7. Rain Garden, State College, Centre County.*





Figure 9-8. Porous concrete sidewalks, State College, Centre County.

### Engineering Plans

The final and critical element to stormwater infiltration system design was to provide the Contractor the required information to build the systems. The subsurface grading of the stormwater infiltration beds was critical to their success. In addition to the cross sections provided, each system should indicate the subsurface contours. An example from the Visitor Center is provided in Figure 9-9. This grading information allowed the earthwork contractor to construct the bed as designed. Because this information is “sub-surface,” it would not normally be part of a site-grading plan. However, adding this grading information to the stormwater plan was critical.

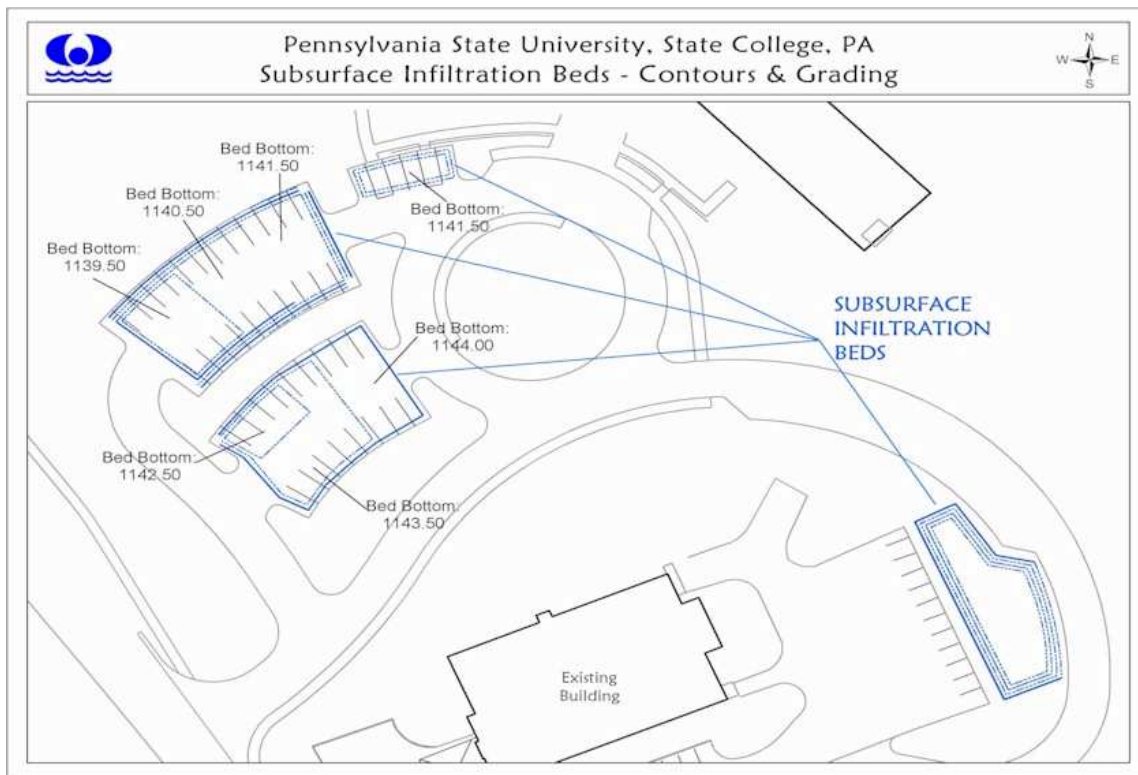


Figure 9-9. Subsurface contours and grading for the infiltration beds at PSU Visitor’s Center, Centre County.

## Case Study 2: Dennis Creek Streambank Restoration, Franklin County

- **Riparian Buffer Reestablishment**
- **Wetland Restoration**
- **Monitoring**

Partnership began with the Franklin County Watershed Association, an informal cooperative group of landowners, farmers, municipal authorities, and other local officials

Part of the Potomac River Basin, the watershed originates in Hamilton Township, Franklin County, near Chambersburg, PA in the pristine headwaters in of the Kittatinny Mountain Ridge. However, nutrient runoff and the presence of cattle in the stream have degraded both the macro-invertebrate life living within the stream as well as the streambanks themselves.

Historically, the watershed and forestland was cleared as fuel for the iron industries, causing severe erosion problems. As the iron industry gave way to the agricultural industry, erosion problems continued and were exacerbated by overgrazing, cattle waste pollution, and unprotected streambanks.

A first step to restore Dennis Creek was to install several miles of streambank fencing to keep cattle out of the stream itself and allow for revegetation of the riparian buffer. This practice alone provided immediate water quality and macro-invertebrate community improvements. Fences are maintained through the local partnership

Because many riparian areas had no trees or vegetation, another task in this project included the streambank planting of trees and native warm season grasses, as well as the restoration of wetlands for stormwater runoff quality control. A newly restored marsh provides animal habitat and water quality improvement in the intensely farmed watershed

A water quality-monitoring program involving government agencies, school students and others has been implemented to measure the project success.

Important project points:

- Total watershed area is 14 square miles
- Resulted in improved hunting and fishing opportunities for community and an educational opportunity for students
- Video located on the web:

[http://www.greentreks.org/watershedstv/more\\_information/featuredtopic\\_denniscreek.asp](http://www.greentreks.org/watershedstv/more_information/featuredtopic_denniscreek.asp)



Figure 9-10. Dennis Creek Watershed in Franklin County, PA.

### Case Study 3: Commerce Plaza III, Lehigh County

- **Vegetated infiltration basin**
- **Concrete level spreader**
- **Vegetated swale**

#### Project Background

Commerce Plaza III, in Upper Macungie Township and South Whitehall Township in Lehigh County, PA is a mid-rise office complex that was proposed for a 49-acre site. A major concern during the design phase was to locate elements of the site stormwater management system away from limestone formations to avoid potential sinkhole problems. The site, historically in agricultural use before subdivision, had a pre-existing sinkhole located near the area slated for stormwater management.

Figure 9-11. Vegetated infiltration basin in Lehigh County.



#### BMP Description

The vegetated infiltration basin (Figure 9-11) collects stormwater runoff from one parking lot and one building, and mitigates runoff from two additional buildings nearby. The basin was designed with a high loading rate of impervious surface runoff to BMP area. Stormwater runoff sheet flows from the inlet to a concrete level spreader (Figure 9-12) into the infiltration basin. The surface of the infiltration basin was graded with extreme care, creating an even basin surface elevation to receive stormwater. Figure 9-13 shows the vegetated swale inflow to the infiltration basin.



Figure 9-12. Level spreader distributes stormwater into the infiltration basin.



Figure 9-13. Vegetated swale

**Soils:** Figure 9-14 shows the Commerce Plaza office location along with the corresponding soil series. The infiltration basin at Commerce Plaza III is located within the Washington soil series. Washington soils found in Lehigh County are deep, well-drained soils, whose underlying material is glacial till, or frost-churned material weathered from limestone.



Figure 9-14. Commerce Plaza soils, NRCS.

**Geology:** Figure 9-15 shows the BMP location along with the corresponding surficial geologic formations. The site is located on the Epler Formation of the Beekmantown Group. The Epler Formation dates from the Lower Ordovician and is a medium to dark-medium gray, finely crystalline, silty limestone interbedded with some thin- to thick-bedded cryptocrystalline dolomite.

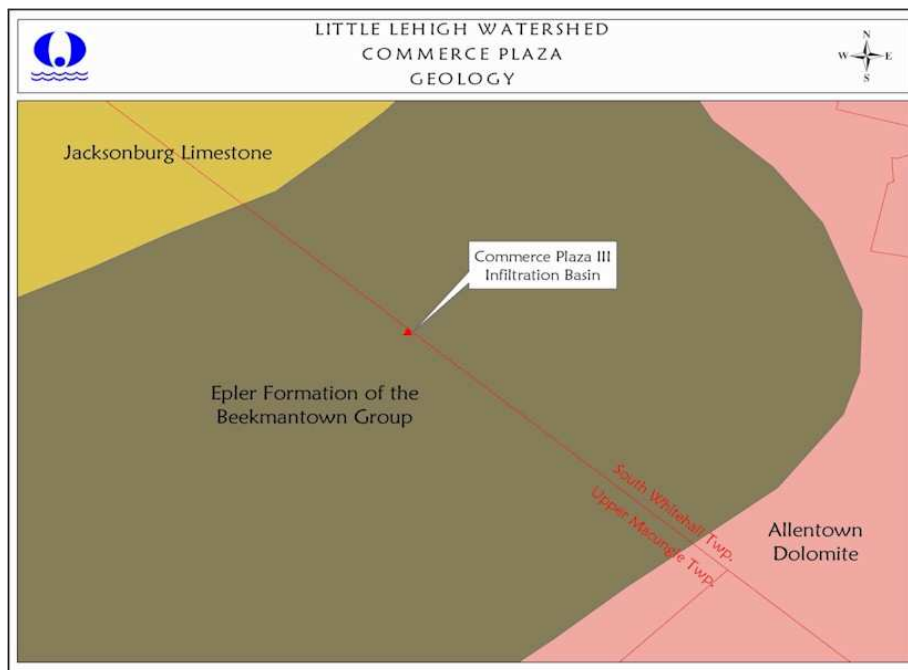


Figure 9-15. Commerce Plaza in Lehigh County is located on limestone geology.

## Case Study 4: Flying J. Truck Plaza for Welsh Oil of Indiana Truck Refueling Terminal, Cumberland County

- **Subsurface Infiltration Bed**
- **Perimeter Trench Drain**
- **Treatment Wetlands**
- **Vegetated Infiltration Filters**
- **Curb Cuts with Filter Strips**

### Project Background

In 1993, Flying J Truck Plaza, a truck refueling facility in Middlesex Township, Cumberland County, Pennsylvania, was faced with complying with municipal open space requirements and the site area needed for their development program. Conventional stormwater detention basins exceeded site area limits required, and as a result, the use of groundwater recharge beds for stormwater management was proposed. Subsurface infiltration beds, located beneath the truck parking facility itself, provided additional space for parking.

Situated over a carbonate formation, the possibility of sinkholes was thoroughly investigated utilizing ground-penetrating radar to map the underlying bedrock. By designing recharge beds to distribute the infiltrating stormwater over a large area where the soil mantle was sufficiently thick, the development of solution channels in the carbonate was minimized. Use of a recharge design for stormwater management for a facility serving as many as 1,500 heavy trucks per day in a sensitive carbonate context had to be coupled with special water quality measures. A two-stage pretreatment system was designed, including a settling unit and vegetated filtration system to remove first flush pollutants from stormwater runoff before entering the groundwater.



Figure 9-16. Perimeter trench drain.



Figure 9-17. Vegetated infiltration filters.

### Site Description

**Soils:** The primary soils found on the site include Duffield silt loam (DuA and DuB), Hagerstown silt loam (HaB), and Huntington silt loam (HuA); with Berks shaley silt loam and Blairton silt loam found primarily around the site perimeter.

Design Images and Details

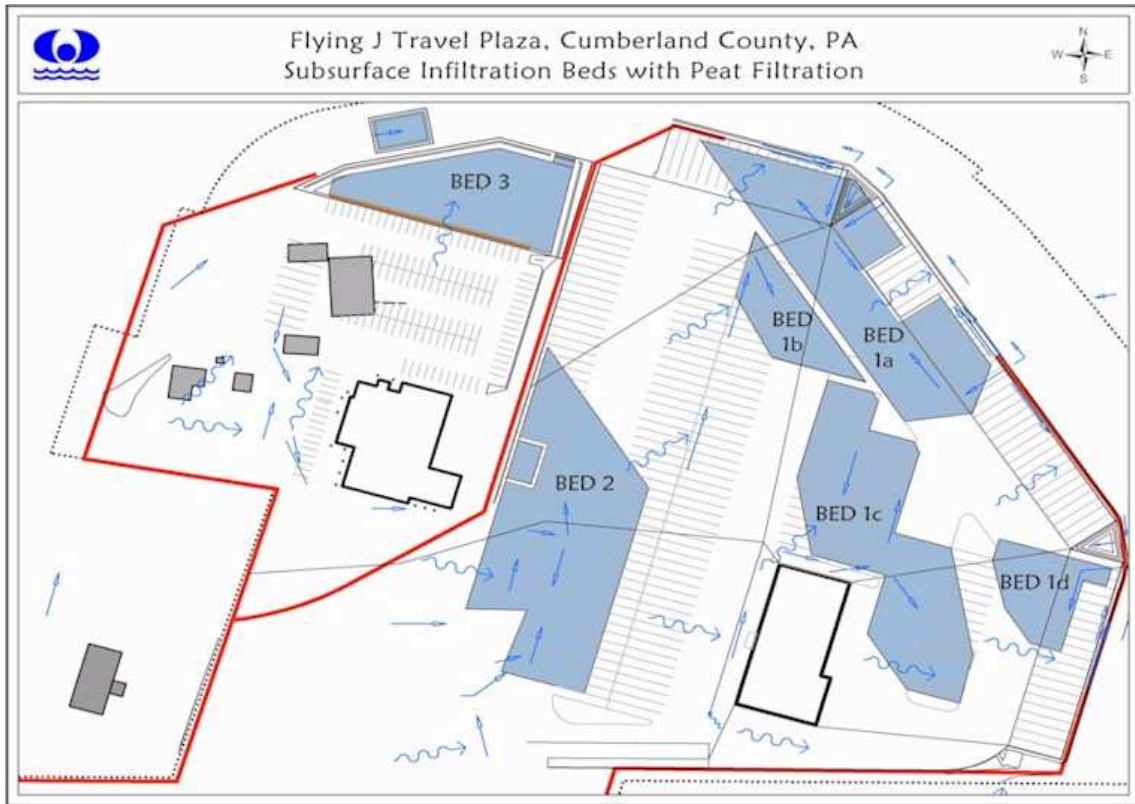


Figure 9-18. Stormwater flow path for the Travel Plaza stormwater management system.

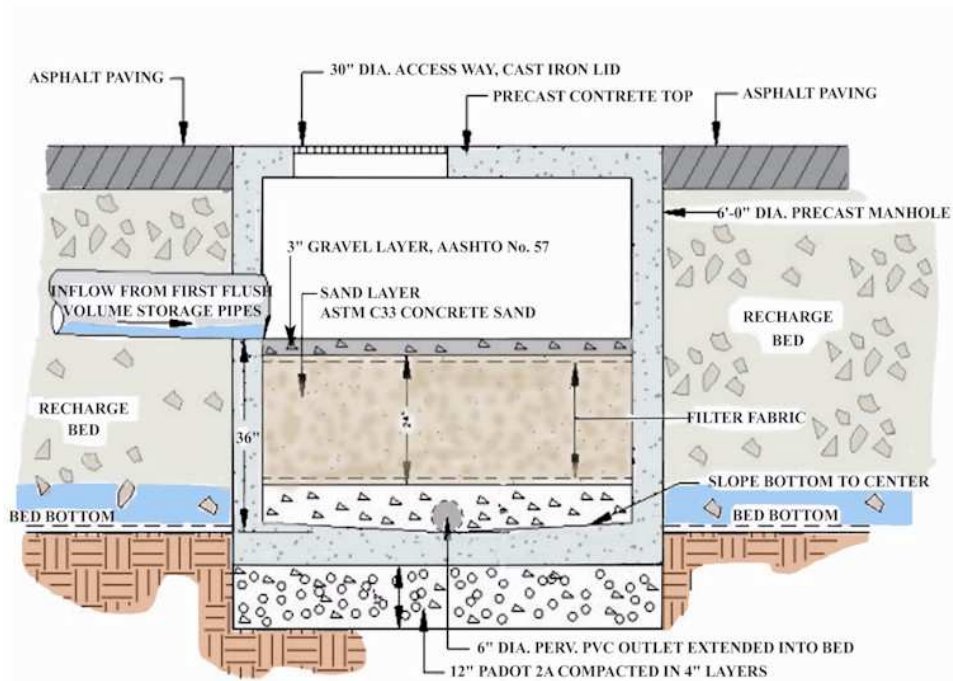


Figure 9-19. Shows the construction design detail for the filter station at the Truck Plaza.

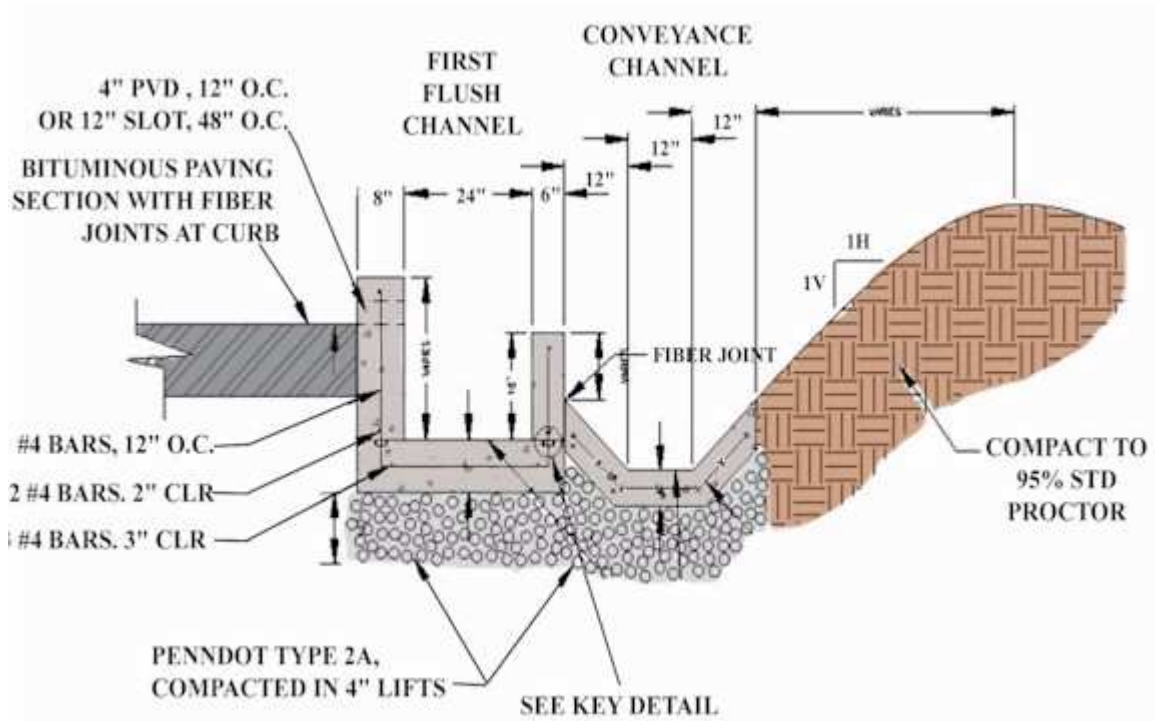


Figure 9-20. Shows the construction design detail for the perimeter channel section.

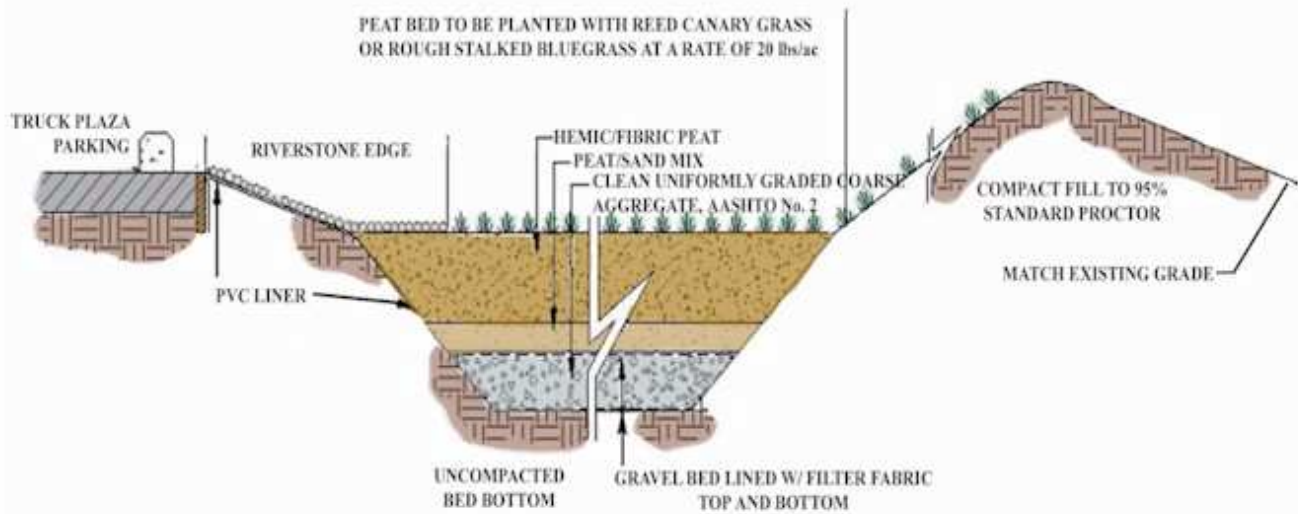


Figure 9-21. Illustrates the peat infiltration bed that is adjacent to the truck parking lot.

## Case Study 5: Ephrata Performing Arts Center, Lancaster County

- **Porous Asphalt parking lot**
- **Vegetated Swale**

### Site Address

Ephrata Performing Arts Center  
Cocalico Road  
Ephrata, PA 17522

### Project Background

The Ephrata Performing Arts Center is located in the existing Grater Park, and includes the Ephrata Playhouse, American Legion, other miscellaneous buildings and associated parking facilities. The project was proposed in coordination with a planned expansion and remodeling of the existing playhouse that required new parking facilities to support the additional use.

The new porous parking lot consists of two rows on each end of the existing lot. A total of 9,200 square feet of porous parking area was installed, providing 40 new parking spaces on the site. The new parking was installed in an existing lawn area and vegetated bioretention swales were included in the design. The project was completed in September 2004.

### Site Description

The site is located within the Cocalico Creek Watershed. The stream is classified WWF (Warm Water Fishery) and is on the 303(d) list of impaired streams for siltation/sediment. The site is bordered to the north by Cocalico Creek.

The site is underlain by the Snitz Creek (CsC) Formation, which is a Cambrian Age Dolomite and Sandstone. All BMPs were installed within the Hagerstown Urban Soil Complex, which is classified as Hydrologic Soil Group "C". Percolation tests were conducted on the underlying soils and infiltration rates observed were ½ inch per hour or greater. There was no disturbance of steep slopes involved in the project; all construction occurred on slopes of 6 percent or less.

### BMP Description

The porous parking is underlain by a stone infiltration bed with various benches ranging in depth from 18 to 48 inches and receives runoff from surrounding impervious driveways and parking areas. The bed connected to the northernmost parking row is designed to overflow to a flat grassed area, and the bed under the southern row discharges to a vegetated bioretention swale. As part of the design, a portion of the existing impervious parking area was removed and a bioretention bed was installed to promote the additional infiltration of runoff conveyed by the existing parking areas.





Figure 9-22. Construction of porous asphalt parking area to compliment building expansion.



Figure 9-23. Completed porous asphalt parking lot at Ephrata Performing Arts Center.

## Case Study 6: Lebanon Valley Agricultural Center, Lebanon County

- **Porous Asphalt parking lot**

### Site Address:

Lebanon Valley Agricultural Center  
2120 Cornwall Road  
Lebanon, PA 17042

### Project Background

The porous parking lot at the Lebanon Valley Agricultural Center was installed to provide additional parking at the existing site. The completed lot provides 58 new spaces, 40 of which are porous. The center drive lane is conventional asphalt with porous pavement limited to the parking bays. The porous parking installation was completed in July 2003.

### Site Description

The Lebanon Valley Agricultural Center is located within the Snitz Creek Watershed, which is classified TSF (Trout Stocking Fishery). The site contains no wetlands, floodplains or riparian zones. Bedrock on the site belongs to the Richland Formation, a carbonate formation composed primarily of finely crystalline dolomite and oolitic limestone. Sandstone beds and pinnacles are present throughout the formation and sinkholes and closed depressions are prevalent. Hydrologic Soil Group (HSG) B and C soils are found on the site.

### BMP Description

The porous pavement parking lot was installed on an existing lawn area and is underlain by a 24 -inch infiltration bed. The bed was excavated and unwoven geotextile fabric was placed on the undisturbed subsoil. Clean AASHTO #1 aggregate was placed in the bed in 12-inch lifts and lightly rolled to prevent settling. Finally, a 3-inch choker course comprised of AASHTO #57 was placed over the larger aggregate and was finish graded to prepare for the asphalt pavement.

The porous parking receives runoff from the center drive lane, which was constructed with conventional asphalt. The overflow design is comprised of four 4-inch pipes placed at the top of the infiltration bed and discharging to a well-vegetated area. Two 6-inch pipes, which discharge to an existing vegetated swale on the site, provide additional overflow. The project site has been observed during several high intensity storms and appears to be working successfully as there was little or no discharge apparent from the overflow pipes.



Figure 9-24. Completed porous asphalt parking lot at Lebanon County Conservation District.

## Case Study 7: Penn State University Berks County Campus, Berks County

- **Porous Asphalt Parking Lots underlain with Subsurface Infiltration Beds**
- **Subsurface Infiltration Trench underlying Standard Asphalt Walkway**
- **Minimum Disturbance**
- **Level Spreader Pipe in the Woods**

In addition to its Main Campus in State College, Pennsylvania State University maintains several satellite campus sites throughout the state. Each of these regional campus sites represents a major investment in educational resources and recently underwent a substantial expansion and development of additional facilities. In 1999, the PSU campus in Reading developed a dormitory complex to accommodate some 400 resident students. The dormitory complex, which consisted of seven attached buildings, was situated in a wooded knoll on the attractive campus. This facility required additional parking spaces for some 320 cars.

Prior to the new development, the area of the campus in question consisted of existing dormitories, a parking lot, a soccer field, a wooded hillside, and lower-lying meadow. The site drains to Tulpehocken Creek, a pristine tailwater fishery that provides habitat to numerous trout species. The soils on the site were mostly well-draining Hydrologic Soil Group 'B' classification. The campus had historically been hindered by the formation of sinkholes in the carbonate bedrock formation underlying it at shallow elevations. In fact, one of the two existing on-site detention basins (Figure 9-25) had suffered from severe sinkhole problems. This particular basin experienced at least two major sinkholes during its lifespan, which required massive (and expensive) remediation efforts involving concrete plugging and lining. The goal of the stormwater management for the new development was thus twofold: mitigation of newly generated site runoff and reduction of existing runoff to the existing basins.



Figure 9-25. Existing sinkhole-plagued detention basin.

The original development plan called for the construction of a new, standard asphalt parking lot in an area of existing woodlands, which would be drained by a new detention basin. The new dormitory complex was going to be located in a highly disruptive fashion in the wooded knoll. The original plan

was eventually discarded in favor of a more sustainable approach involving minimum disturbance, volume reduction, water quality improvement, and groundwater recharge. The first major improvement to the plan was the repositioning of the new dormitories in a more organic fashion along the contours in the woods. This sensitive positioning preserved healthy trees and minimized earth disturbance, which was limited to within 15ft of the new structures. Another major improvement was relocating the new parking lot away from existing woods and into the meadow. Also, this parking lot was constructed with porous asphalt and underlain by an aggregate infiltration bed.

The stormwater management plan for the developed site was a great improvement over the existing condition. Stormwater management for new dormitories consisted of an aggregate infiltration trench beneath a standard asphalt walkway “interior” of the complex and “exterior” level spreader perforated pipes along contours in the woods. Roof leaders on the interior halves of the dormitories were connected to the aggregate trench/walkway. (These walkways were stabilized beyond the standard asphalt by a “grass pavement” for fire truck access.) Likewise, roof leaders on the exterior halves were directly connected to the level spreader perforated pipes in the woods. These laterally extending pipes were designed to maintain soil moisture for the woodlands.



Figure 9-26. Example of minimum disturbance and prevent erosion or disturbance on the hillside.



Figure 9-27. Level spreader pipe/infiltration trench in woods.



Figure 9-28. Standard asphalt walkway w/ subsurface infiltration trench.

The new porous asphalt parking lot was designed to mitigate incident rainfall and direct runoff from the nearby access road and existing dormitories. The porous parking lot has so far effectively discouraged the concentration of stormwater runoff downhill and allowed the incident rainfall to pass directly through the parking bays, slowly percolating into the soil and recharging the aquifer system. This system has also dramatically reduced discharges to the existing sinkhole-plagued basins. To date, neither the porous parking lot nor the existing basins have experienced additional sinkhole problems. Furthermore, polluted runoff from the site, usually described as nonpoint source pollution (NPS), was significantly removed by the overall plan. The new improvements at the PSU Berks County campus have had virtually zero impact on regional water resources.

The cost of the new porous asphalt parking lot with subsurface aggregate infiltration bed came to around \$1100 per space, in 1999 dollars. When all related site work (lighting, landscaping, erosion and sedimentation control, etc.) was considered, the final cost per space was around \$2200, also in 1999 dollars



Figure 9-29. Porous asphalt parking lot with subsurface infiltration bed.

## Case Study 8: Warm Season Meadows at Williams Transco, East Whiteland Township, Chester County

- **Re-Vegetation as Natural Open Space Meadow, Using Native Plants and Replacing Maintained Lawn**

### Project Background

This site is largely unpaved land consisting of fields interspersed with an office building, an employee parking area, and utility structures and right-of-way areas, all previously maintained as conventional lawn area. Utility line areas consist primarily of poles, towers, and guidelines that disturb minimum earth once in place.

At this utility company corporate office and utility right-of-way site in the Valley Creek Watershed (classified as Exceptional Value, EV), a re-landscaping plan was developed for the site, which included use of native warm season meadow grasses well suited to the local climate. Re-landscaping included switch grass and native blue stem, planted on about 25 acres of land that had previously been fields of relatively conventional turf grass that was subject to fertilizer and herbicide/pesticide applications as well as regular mowing. Prior to this planting of meadow grasses, herbicide was carefully applied to kill existing vegetation including undesirable invasive plants; this herbicide application was timed so that it wouldn't harm an existing stand of native blue stem. The native meadow grasses were planted using no-till planting practices to prevent excessive earth disturbance. The new grasses grow during the middle of the growing season and are dormant in the spring and fall. They are best harvested after the spring nesting season, but require no mowing.

### Stormwater Management Functional Benefits

Establishing warm season meadow of native grasses is included in this manual as a BMP because the overall environmental performance of unmowed, unmaintained native grass meadows is superior to that of mowed and maintained turf grass fields, both in terms of stormwater quantity and stormwater quality. Meadows promote stormwater infiltration into the ground; through interception of any stormwater flow (sheet or channelized), rate of flow is slowed. Periodic application of fertilizers and herbicides is eliminated; therefore chemical pollution to surface runoff as well as to the groundwater is reduced. Native grasses also have a greater potential to uptake any pollutants present in stormwater runoff, in contrast to conventional turf grass, although no pollutant reduction analysis specifically has been performed for this BMP project. To a large extent, sediment and grit, oil and grease, as well as nutrients present in site stormwater runoff will be filtered by the natural biological and physical filtration processes provided by native meadow grasses prior to being discharged into receiving waters or being percolated deeper into the groundwater. Additionally, established warm season grassy meadows provide natural open space habitat and are especially attractive to wildlife, including birds.

**Operation and Maintenance:** The Chester County Conservation District considers planted meadows to be a "low maintenance" BMP. Warm season native meadow grasses should be burned every 3 to 4 years to invigorate stem growth, remove thatch, and eliminate growth of invasive plants. At this site, burning is not an acceptable management option due to the nature of current site activities and proximity to residential areas; however, as an alternative to burning, the site owner can harvest cut on a 3-4 year cycle. The new meadow grasses with their low nutrient requirements, do not require fertilization above and beyond available soil nutrients. Meadow grass does need to be periodically cut around guide wires, structures and buildings to permit inspection and maintenance of structures. To ensure that this BMP is maintained properly, procedures and specifications for meadow maintenance should be documented and maintained on the site.

### Cost Issues

The cost of establishing native meadows is low, relative to many other types of stormwater management practices, and is typically not significantly more expensive than installation of a conventional landscape. Operating and maintenance costs usually are less than conventional landscaping. For example, at this site, the warm season meadow offers the site owner cost savings conservatively estimated at \$350 per acre per year through avoidance of mowing, without including the added costs of fertilization and herbicide applications. Additionally, the meadow grasses can be harvested annually and sold at current market value. Other factors that may affect cost of establishing a warm season grass meadow include site conditions, such as the cost of land, local topography, rocky or highly permeable soil, and bedrock.

### For More Information

For more information about this BMP site, contact the site owner, Williams Transco, at 610-644-7373 (Robert Hill, Assistant District Manager). Although this site is part of the Chester County BMP Tour, site visits should be individually arranged. Also, Tim Smail at the Chester County office of the USDA-Natural Resource Conservation Service assisted in the BMP design.



*Figures 9-30 & 9-31. Warm season native grassy meadows established at this site provide greater stormwater infiltration opportunities than maintained turf grass fields. Low maintenance meadows enhance wildlife habitat.*

## Case Study 9: Hills of Sullivan Residential Subdivision, London Grove Township, Chester County

- **Infiltration Trenches**
- **Berms**

### Project Background

This sizable single-family development was constructed over 15 years ago and is located in the White Clay Creek watershed (classified CWF, TSF). London Grove Township at that time was one of the few municipalities in Chester County, as well as the state, to require in its stormwater regulations that runoff volumes for up to the 2-year storm not be increased, pre- to post-development. The site can be reached from Rose Hill Road south, left onto Avondale Road, right onto Clay Creek Road, left onto Angelica Drive and then best accessed via the trail located in HOA-owned open space (follow a narrow trail from Angelica Drive just above a bridge and above the creek).

### Project Description

At the encouragement of the Township and its Municipal Engineer, an integrated system of berms and infiltration trenches was constructed. The typical berm/trench consisted of narrow, elongated, surface depressions created by built up earthen embankments, or berms, that promote stormwater infiltration. At this site, the infiltration trenches are elongated, shallow trenches on the surface that collect and temporarily store stormwater runoff from the upslope residential lots and streets and promote its infiltration (in contrast to sub-surface, excavated, fabric-wrapped, stone-filled trenches as described in Chapter 6). Stormwater that collects in these narrow depressions on the hillside gradually seeps through the soil into the ground and eventually into the creek and water table below. These berms/trenches follow the contours of the land in a parallel sequence. There are three 400 foot-long trenches terraced, or stepped, down the slope with one below another.

When the uphill trench is filled to capacity, stormwater overflows into the trench below. There is also a single 1,000 foot-long trench that functions independently of the three terraced trenches. This large trench receives stormwater through a subsurface pipe. Because stormwater entering this trench is conveyed through a pipe with a steep slope and has high velocity, a concrete chamber is used to dissipate its energy before discharging into the trench. When this trench overflows, stormwater spills over its downslope berm and flows down the bank into the stream below. For an infiltration trench to properly function, the bottom soil must be permeable and remain uncompacted for the life of the structure. Soil percolation tests performed prior to trench construction and at the conclusion of earth disturbance are used to ensure soil infiltration capacity. Vegetation has naturally established itself in the trenches. The berms, which double as a walking path, consist of a gravel and grassy base and are wide enough to permit access for future maintenance of these structures.

### Stormwater Function

Infiltration trenches replenish the water table, recharge groundwater supplies, and stabilize base flow in streams. They provide efficient recharge because the infiltration occurs relatively close to where the runoff is generated, thus limiting evaporative loss and infiltrating more rainfall. Infiltration trenches provide an opportunity for physical filtration of pollutants in stormwater runoff removing suspended solids including dirt and sand particles (solids accumulate in vegetation and bottom soils). Oil and grease bound to suspended particles, and their heavy metal constituents, may also be filtered from runoff. These structures also provide naturally vegetated open space for wildlife. The trenches/berms function as a walking trail for the community and provide maintenance access.



This BMP is not advisable for use in drainage areas that have extensive stormwater pollution sources (i.e., “hotspots”), because by itself such a system has limited pollutant removal capabilities. Functioning as designed, infiltration structures can approximate the following pollutant removal efficiencies for non-excessive nonpoint source pollutant loadings as would be expected from single-family residential land uses:

- Total Suspended Solids (TSS): 95 %
- Total Phosphorus: 70 %
- Total Nitrogen: 51 %
- Metals (copper and zinc): 99 %
- Bacteria: Not Applicable

**Operation and Maintenance:** The Chester County Conservation District considers infiltration trenches to have moderate maintenance requirements. Operation and maintenance requirements include the following (provided in this case by the Homeowners’ Association):

- Regularly inspect to ensure adequate infiltration
- Regularly inspect structural components (i.e. energy dissipater, inlet structure) to ensure they are functioning properly
- Periodically trim plants to ensure their growth does not impede the flow of water through the structure
- Remove invasive plants as necessary (remove shoots and roots)
- Routinely remove accumulated trash and debris
- Avoid running heavy equipment in the trenches to prevent soil compaction
- At the completion of construction, scrape soils to remove accumulated sediment and conduct soil percolation test
- Do not apply chemical pesticides or fertilizers to turf in and around infiltration structures

### **Cost Factors**

In general, the cost to construct and maintain infiltration trenches is usually comparable to the cost of constructing and maintaining large stormwater basins, which would have otherwise been necessary. Given the age of this project, specific cost data have not been available. Soil percolation tests performed before and after construction, as well as measures taken to protect the infiltration basin from sediment inundation during construction add moderately to project costs, but are essential in order to ensure proper function of the infiltration trenches/berms.

### **For More Information**

Contact London Grove Township at 610-345-0100 or the Township Engineer, Larry Walker (URS) at 302-791-0700. London Grove Township has worked to apply this and other infiltration-oriented BMPs in other developments, such as Ashland Woods, located near the intersection of Sullivan Road and New Garden Station Road on Jack Reynolds Way, where infiltration basins are located on individual lots owned by individual homeowners.



*Figure 9-32. View from Clay Creek Rd: trenches/berms at the base of the grassy hill in background; trenches/berms barely visible through trees as horizontal undulations.*



*Figure 9-33. This grassy path is an embankment, or berm, creating depressions for recharge trenches located to the left of the path.*



*Figure 9-34. Narrow, vegetated infiltration trenches/berms follow land contours and take on a naturalized appearance.*



*Figure 9-35. This trench/berm has a subsurface energy dissipater to reduce the velocity of entering stormwater.*

## Case Study 10: Applebrook Golf Course Community, Chester County

- **Constructed Treatment Wetland**
- **Two Wet Ponds**
- **Grass Swales**
- **Fertigation**
- **Cold Water Discharge**
- **Open Storage**

In the spring of 2002, stormwater management improvements were constructed at Applebrook Golf Course Community in East Goshen, Chester County. These improvements were intended to substantially improve the quality of site runoff, reduce the peak runoff rates, stabilize flow to adjacent natural wetlands and streams, and provide stable habitat for plants and wildlife, including sensitive and native endangered species. As the site is within the Ridley Creek watershed, which is deemed Exceptional Value by the state, these goals were especially important.



The most significant BMPs constructed as part of the strategy were a constructed treatment wetland and two wet ponds. Other stormwater measures at the golf course included grass swales, fertigation (fertilization and irrigation), cold-water discharges, and open space donation. The constructed treatment wetland at the site was designed primarily with water quality objectives in mind. It was constructed in a low-lying area near natural wetlands in the Ridley Creek floodplain. This allowed it to take advantage of inflows of water between storm events and to maintain sufficient soil moisture. Through physical, biological, and chemical processes, constructed wetlands can efficiently remove a great many contaminants commonly found in runoff (suspended solids, nutrients (nitrogen and phosphorus), heavy metals, toxic organics, and petroleum compounds). Wetland vegetation, algae, and bacteria allow for the biological uptake of contaminants. Wetland vegetation also provides physical and chemical pollutant filtering mechanisms, which greatly enhance the quality of the runoff from the golf course, as well nearby residential development. Constructed wetlands also play a role in reducing peak rates from a

site, stabilize flow, and

*Figure 9-36. Constructed wetland in background.* provide valuable habitat opportunities.

A wet pond is a stormwater management feature that maintains a permanent pool of water (retention) and has additional capacity for stormwater detention. Two wet ponds were constructed at the golf course as part of the improvements. The smaller of these two wet ponds has the preferable elongated shape, while the larger is comprised of two cells. When the first cell has reached capacity, water spills over into the second cell. The larger pond receives treated wastewater from a nearby, township-owned wastewater treatment facility. Water is pumped from this pond and used in the site's fertigation system.

Constructed wetlands are considered to be a low to moderate stormwater BMP. Typical operation and maintenance requirements include: manual adjustment of the water level (especially during plant establishment), manual removal of invasive plant species, and cleaning out of outlet structures when excessive amounts of sediment have accumulated.



Figure 9-37. Large pond, constructed wetland, managed and naturalized areas of golf course.

Other BMPs constructed at the golf course include grass swales, fertigation, cold-water discharges, and open space donation. The various grass swales at the golf course provide a sustainable alternative to concrete-lined channels or conventional storm sewers. Their many benefits include the filtering out of runoff pollutants, large storm conveyance, enhanced infiltration opportunities, and peak rate reduction.

The site's fertigation system provides a sustainable alternative to conventional fertilization. The system uses water from the larger of the two wet ponds, which receives wastewater effluent from the Township's nearby sewage treatment plant. Water from this wet pond is pumped for use in golf course irrigation and fertilization. This system allows fertilizers to be introduced to the irrigation water in solution form, a technique that allows 100% fertilizer use, as opposed to only 20% when dry fertilizer application is employed.

Water from the wet pond is pumped at or near the bottom so that the coldest water is returned to Ridley Creek. This is an important consideration for the trout in the exceptional value creek. The development includes an area of wetlands of approximately 70 acres that was donated by the developer to the Township as open space. There is a conservation easement on this land, which restricts the cutting/mowing of vegetation to permit wetland plants to mature. The eased land includes the constructed wetland, the natural wetland, the stream, and its adjacent floodplains.



Figure 9-38. Pond water is pumped up to a waterfall and returns to pond through grass swales enhancing aeration.

**References**

*Chester County Stormwater BMP Tour Guide.* Published by Chester County Conservation District.

Center for Watershed Protection. *A Review of Stormwater Treatment Practices* (published presentation).

Pennsylvania Handbook of Best Management Practices for Developing Areas. Spring 1988.  
CH2MHILL

### **Case Study 11: Swan Lake Drive Development, Delaware County**

- **Vegetated Infiltration Beds**

#### **Site Address**

Swan Lake Drive  
Concord, PA 19061  
Delaware County

#### **Project Background**

This project consists of the development of eight single-family dwellings on approximately 12 acres near the intersection of Mattson and Concord Roads in Delaware County. Stormwater on the site is managed with on-lot vegetated infiltration beds which reduce runoff volume and help protect water quality within an existing spring fed pond and associated wetlands.

#### **Site Description**

The Swan Lake Drive Development is located within the Greens Creek Watershed, which drains to the West Branch of Chester Creek. Predevelopment conditions on the site consisted of rolling farmland with woodlands located on the northern third of the property. Three small streams traverse through the parcel from west to east. Adjacent to the streams are floodplains with some associated wetland areas.

Existing soils on the property consist of the Glenville, Glenelg, Brandywine and Worsham Series. All soils are classified as silt loams and range in permeability from moderate to low permeability. Infiltration testing was conducted on the site and the soils were found to be suitable for infiltration.

#### **BMP Description**

Vegetated infiltration beds were constructed to manage the rooftop runoff from each individual lot as well as runoff generated by driveway and road areas from a large portion of the development. The remaining runoff on site was conveyed to the existing pond. Shallow subsurface infiltration beds (no greater than 2.5 feet deep) were installed on all eight lots and rooftop runoff from each home is conveyed to the onsite infiltration bed. A larger infiltration bed was constructed to manage the runoff from driveways and Swan Lake Drive. Stormwater overflow and some overland flow are directed into the existing pond at the bottom of the site. The infiltration systems on the site provide capacity to store/infiltrate approximately 11,000 cubic feet of runoff over a 24-hour period.



---

# **Pennsylvania Stormwater Best Management Practices Manual**

---

## **Appendix A – Water Quality**

### **Pollutant Event Mean Concentrations by Land Cover & BMP Pollutant Removal Efficiencies**







# **Pollutant Event Mean Concentrations by Land Cover**



**TABLE A-1. EVENT MEAN CONCENTRATIONS (EMCs) FOR TOTAL SUSPENDED SOLIDS**

	LAND COVER CLASSIFICATION	TSS EMC (mg/l)	SOURCES	COMMENTS
<b>Pervious Surfaces</b>	Forest	39	B, G, M	---
	Meadow	47	B, N	---
	Fertilized Planting Area	55	Q, R	R: "Residential" area had considerable mulched areas
	Native Planting Area	55	Q, R	R: "Residential" area had considerable mulched areas
	Lawn, Low-Input	180	C, O, Q, R	Median of four values
	Lawn, High-Input	180	C, O, Q, R	Median of four values
	Golf Course Fairway/Green	305	M, R	Average of two values
	Grassed Athletic Field	200	M, N	Average of two values
<b>Impervious Surfaces</b>	Rooftop	21	Q, S, V	Average of Residential, Commercial, and Industrial Roofs
	High Traffic Street / Highway	261	E, F, H, P, Q	Median of five values
	Medium Traffic Street	113	A, B, H, I, J, P, Q	Median of seven values
	Low Traffic / Residential Street	86	E, P, Q	Average of three values
	Res. Driveway, Play Courts, etc.	60	M	"Urban Recreation"
	High Traffic Parking Lot	120	J, N, Q	Median of three values
	Low Traffic Parking Lot	58	I, M, N, Q	Median of 4 values w/ "comm.", "indust.", "parking" & "comm/res."

**TABLE A-2. EVENT MEAN CONCENTRATIONS (EMCs) FOR TOTAL PHOSPHORUS**

	LAND COVER CLASSIFICATION	TP EMC (mg/l)	SOURCES	COMMENTS
<b>Pervious Surfaces</b>	Forest	0.15	B, I, J, M, R, X	---
	Meadow	0.19	F, W	Value from F, W reported no soluble phosphorus from meadow
	Fertilized Planting Area	1.34	F	Study indicated highly maintained landscapes in "High Density Resid."
	Native Planting Area	0.40	F, W	W had no soluble P from mulch, assumed equivalent to low-input lawn
	Lawn, Low-Input	0.40	F	Value for "Low Density Residential"
	Lawn, High-Input	2.22	K, L, S, V	Median of four values
	Golf Course Fairway/Green	1.07	R	---
	Grassed Athletic Field	1.07	R	No data found, assumed equivalent to golf course
<b>Impervious Surfaces</b>	Rooftop	0.13	L, S, V	Median of three values
	High Traffic Street / Highway	0.40	L, P, S	Median of 3 values including "Arterial St." and "Urban St."
	Medium Traffic Street	0.33	I, L, M, X	Median of 4 values including "Transportation"
	Low Traffic / Residential Street	0.36	L, P, S, V	Median of 4 values including "Feeder St." and "Rural Rd."
	Res. Driveway, Play Courts, etc.	0.46	L, M, S, V	Median of 4 values including "Urban Recreation"
	High Traffic Parking Lot	0.39	S	---
	Low Traffic Parking Lot	0.15	N, S, V	Median of three values

**TABLE A-3. EVENT MEAN CONCENTRATIONS (EMCs) FOR NITRATE**

	LAND COVER CLASSIFICATION	Nitrate-Nitrite EMC (mg/l as N)	SOURCES	COMMENTS
<b>Pervious Surfaces</b>	Forest	0.17	J	---
	Meadow	0.3	B	EMC for TN adjusted
	Fertilized Planting Area	0.73	F, R	Studies indicated mulched areas & highly maintained landscapes
	Native Planting Area	0.33	T	Assumed equivalent to turfgrass w/o chemical treatment
	Lawn, Low-Input	0.44	T, U, W	Based on studies of lawn runoff and leachate
	Lawn, High-Input	1.46	C, T, U	Median of 3 studies in T and NURP data in C - consistent with U
	Golf Course Fairway/Green	1.84	M, R, U	Average of 3 values including one study of leachate
	Grassed Athletic Field	1.01	M	---
<b>Impervious Surfaces</b>	Rooftop	0.32	L, U	---
	High Traffic Street / Highway	0.83	D, F, I, L, P	Median of five values
	Medium Traffic Street	0.58	D, I, L, P	Median of four values
	Low Traffic / Residential Street	0.47	V	EMC for TN adjusted
	Res. Driveway, Play Courts, etc.	0.47	V	Assumed equivalent to residential street
	High Traffic Parking Lot	0.60	F	Value reported for "Retail"
	Low Traffic Parking Lot	0.39	C, F, L	Median of 3 values after EMC for TN adjusted

## REFERENCES

## REFERENCES FOR TABLES A-1, A-2, AND A-3

- A. Weiss, W. and Guerard, P. 1995. "Water Quality of Storm Runoff and Comparison of Procedures for Estimating Storm-Runoff Loads, Volume, Event-Mean Concentrations, and the Mean Load for a Storm for Selected Properties and Constituents for Colorado Springs, Southeastern Colorado, 1992," Water-Resources Investigations Report 94-4194, U.S. Geological Survey.
- B. CH2MHILL, 2002. Watershed Modeling Technical Memorandum No. 8, prepared for Wake County, NC. Available at [http://projects.ch2m.com/WakeCounty/Docs/TM8\\_model%20assumptions.pdf](http://projects.ch2m.com/WakeCounty/Docs/TM8_model%20assumptions.pdf).
- C. U.S. Environmental Protection Agency, 1999. "Preliminary Data Summary of Urban Storm Water Best Management Practices," EPA-821-R-99-012, Office of Water, Washington, DC.
- D. Thomas, A., Tellam, J., and Greswell, R. "Development of a GIS Based Urban Groundwater Recharge Pollutant Flux Model," School of Earth Sciences, University of Birmingham, UK.
- E. Federal Highway Administration. "Stormwater Best Management Practices in an Ultra-Urban Setting: Selection and Monitoring." Available at <http://www.fhwa.dot.gov/environment/ultraurb/>.
- F. McConnell, R., Araj, E., and Jones, D., 1999. "Developing Nonpoint Source Water Quality Levels of Service for Hillsborough County, Florida," presented at the Sixth Biennial Stormwater Research & Watershed Management Conference.
- G. "Wake County Watershed Management Plan," July 25, 2001, presented by Wake County, CH2MHILL, and the Center for Watershed Protection.
- H. U.S. Environmental Protection Agency, 2001. "PLOAD Version 3.0 User's Manual: An ArcView GIS Tool to Calculate Nonpoint Sources of Pollution in Watershed and Stormwater Projects."
- I. Baird, C., Dybala, T., Jennings, M., and Ockerman, D., 1996. "Characterization of Nonpoint Sources and Loadings to Corpus Christi Bay National Estuary Program Study Area," Corpus Christi Bay National Estuary Program, CCBNEP-05.
- J. "The Simple Method to Calculate Urban Stormwater Loads" available from the Center of Watershed Protections' *Stormwater Manager's Resource Center* at: <http://www.stormwatercenter.net/monitoring%20and%20assessment/simple%20meth/simple.htm>.
- K. Green Valleys Association (GVA), 1999. *Sustainable Watershed Management for Northern Chester County Watersheds: A Model Program to Balance Water Resources and Land Development in the Schuylkill River Tributary Watersheds: French Creek, Pickering Creek, Pigeon Creek, Stony Run, and Direct Schuylkill Drainage*. Technical Assistance From: Cahill Associates, Inc. and Brandywine Conservancy.
- L. Ed. Schueler, T.R. and H.K. Holland, 2000. "Storm Pollution Source Areas Isolated in Marquette, Michigan (Technical Note #105)," article in the edited anthology *The Practice of Watershed Protection*, Center of Watershed Protection, Ellicott City, MD.

- M.** Philadelphia Water Department, Office of Watersheds, 2000. *Technical Memorandum No. 3: A Screening Level Contaminant Loading Assessment for the Darby and Cobbs Creek Watershed (DRAFT)*.
- N.** Larm, T., 2000. *Watershed-based design of stormwater treatment facilities: model development and applications, Doctoral Thesis*. Division of Water Resources Engineering, Department of Civil and Environmental Engineering, Royal Institute of Technology, Stockholm, Sweden.
- O.** United States Environmental Protection Agency (USEPA), 1993. *Guidance Specifying Management Measures for Sources of Nonpoint Pollution in Coastal Waters (EPA 840-B-92-002)*.
- P.** United States Environmental Protection Agency (USEPA), 1983. *Results of the Nationwide Urban Runoff Program, Volume I: Final Report*, Water Planning Division, Washington, D.C. December 1983. & Federal Highway Administration (FHWA), 1990. *Pollutant Loadings and Impacts from Highway Stormwater Runoff Volume III: Analytical Investigation and Research Report*, FHWA-RD-88-008, Office of Engineering and Highways Operations R&D, McLean, VA.
- Q.** Center for Watershed Protection, 1996. *Design of Stormwater Filtering Systems*. Prepared for the Chesapeake Research Consortium.
- R.** Jennings, G., D. Line, B. Hunt, D. Osmond, Nancy White. *Neuse River Basin Pollution Sources and Best Management Practices*.
- S.** Bannerman, R.T., R. Dodds, D. Owens, and P. Hughes, 1992. *Sources of Pollutants in Wisconsin Stormwater*. Wisconsin Department of Natural Resources and U.S. Geological Survey. Prepared for USEPA.
- T.** Ed. Schueler, T.R. and H.K. Holland, 2000. "Nitrate Leaching Potential from Lawns and Turfgrass (Technical Note #56)," article in the edited anthology *The Practice of Watershed Protection*, Center of Watershed Protection, Ellicott City, MD.
- U.** Ed. Schueler, T.R. and H.K. Holland, 2000. "Nutrient Movement from the Lawn to the Stream (Technical Note #4)," article in the edited anthology *The Practice of Watershed Protection*, Center of Watershed Protection, Ellicott City, MD.
- V.** Center for Watershed Protection, 2003. *New York State Stormwater Management Design Manual*. Prepared for New York State Department of Environmental Conservation.
- W.** Ed. Schueler, T.R. and H.K. Holland, 2000. "The Peculiarities of Perviousness (Technical Note #129)," article in the edited anthology *The Practice of Watershed Protection*, Center of Watershed Protection, Ellicott City, MD.
- X.** Kieser & Associates, 2001. *Non-point Source Modeling of Phosphorous Loads in the Kalamazoo River/Lake Allegan Watershed for a Total Maximum Daily Load*. Prepared for The Kalamazoo Conservation District, Kalamazoo, MI.



### ADDITIONAL REFERENCES

- Choe, J.S., K.W. Bang, and J.H. Lee, 2002. "Characterization of surface runoff in urban areas," *Water Science & Technology*, 45(9): 249-254.
- Clinton, B.D. and Vose, J.M., 2003. Differences in Surface Water Quality Draining Four Road Surface Types in the Southern Appalachians, *Southern Journal of Applied Forestry*, 27(2).
- County of Los Angeles, Department of Public Works, 2000. *Los Angeles County 1999-2000 Stormwater Monitoring Report*.
- James, R.B., 1999. Solids in Storm Water Runoff. *Water Resources Management*.
- National Atmospheric Deposition Program/National Trends Network, 2001. *2000 Annual & Seasonal Data Summary for Site NC41*.
- Ed. Schueler, T.R. and H.K. Holland, 2000. "Is Rooftop Runoff Really Clean (Technical Note #8)," article in the edited anthology *The Practice of Watershed Protection*, Center of Watershed Protection, Ellicott City, MD.

# **BMP Pollutant Removal Efficiencies- Percent Efficiency**

Table A-4. Summary of pollutant removal efficiencies of stormwater BMPs.

<b>COMPREHENSIVE BMP LIST</b>				
		<b>Pollutant Removal Efficiency %</b>		
		TSS	TP	NO3
<b>Non-Structural BMP</b>				
5.4.1	Protect Sensitive / Special Value Features	SC	SC	SC
5.4.2	Protect / Conserve / Enhance Riparian Areas	SC	SC	SC
5.4.3	Protect / Utilize Natural Flow Pathways in Overall Stormwater Planning and Design	30	20	0
5.5.1	Cluster Uses at Each Site; Build on the Smallest Area Possible	SC	SC	SC
5.5.2	Concentrate Uses Areawide through Smart Growth Practices	SC	SC	SC
5.6.1	Minimize Total Disturbed Area - Grading	40	0	0
5.6.2	Minimize Soil Compaction in Disturbed Areas	30	0	0
5.6.3	Re-vegetate and Re-forest Disturbed Areas using Native Species	85	85	50
5.7.1	Reduce Street Imperviousness	SC	SC	SC
5.7.2	Reduce Parking Imperviousness	SC	SC	SC
5.8.1	Rooftop Disconnection	30	0	0
5.8.2	Disconnection from Storm Sewers	30	0	0
5.9.1	Streetsweeping	85	85	50
<b>Structural BMP</b>				
6.4.1	Porous Pavement with Infiltration Bed	85	85	30
6.4.2	Infiltration Basin	85	85	30
6.4.3	Subsurface Infiltration Bed	85	85	30
6.4.4	Infiltration Trench	85	85	30
6.4.5	Rain Garden / Bioretention	85	85	30
6.4.6	Dry Well / Seepage Pit	85	85	30
6.4.7	Constructed Filter	85	85	30
6.4.8	Vegetated Swale	50	50	20
6.4.9	Vegetated Filter Strip	30	20	10
6.4.10	Infiltration Berm and Retentive Grading	60	50	40
6.5.1	Vegetated Roof	85	85	30
6.5.2	Rooftop Runoff - Capture and Reuse	100	100	100
6.6.1	Constructed Wetland	85	85	30
6.6.2	Wet Pond / Retention Basin	70	60	30
6.6.3	Dry Extended Detention Basin	60	40	20
6.6.4	Water Quality Filter	60	50	20
6.7.1	Riparian Buffer Restoration	65	50	50
6.7.2	Landscape Restoration	85	85	50
6.7.3	Soils Amendment and Restoration	85	85	50

SC, Self Crediting: The BMP reduces the pollutant load, thus is self-crediting. BMPs with this designation are labeled as " Preventive" in Section 5.

\*\* All values shown represent professional interpretation, based upon best available data as provided in Appendix A.\*\*

5.9.1 STREETSWEEPING

Type	Pollutant Removal % Efficiency						Primary Source	Secondary Source	Comments
	TSS	TN	NO <sub>3</sub>	NO <sub>x</sub>	TKN	TP			
Biweekly Sweeping	40-60					20-40	Kurahashi & Associates, Inc. 1997. Port of Seattle - Stormwater Treatment BMP Evaluation. Prepared for the Port of Seattle, Pier 66. Prepared by Kurahashi & Associates, in association with AGI Technologies.	Federal Highway Administration (FHWA). "Stormwater Best Management Practices in an Ultra-Urban Setting: Selection and Monitoring – Monitoring Case Study-Streetsweeping BMP Evaluation, Port of Seattle, Washington." U.S. Department of Transportation.	Land Use = cargo container yards
Weekly Sweeping	45-65					30-55	Kurahashi & Associates, Inc. 1997. Port of Seattle - Stormwater Treatment BMP Evaluation. Prepared for the Port of Seattle, Pier 66. Prepared by Kurahashi & Associates, in association with AGI Technologies.	Federal Highway Administration (FHWA). "Stormwater Best Management Practices in an Ultra-Urban Setting: Selection and Monitoring – Monitoring Case Study-Streetsweeping BMP Evaluation, Port of Seattle, Washington." U.S. Department of Transportation.	Land Use = cargo container yards
Twice Weekly Sweeping	45-70					35-60	Kurahashi & Associates, Inc. 1997. Port of Seattle - Stormwater Treatment BMP Evaluation. Prepared for the Port of Seattle, Pier 66. Prepared by Kurahashi & Associates, in association with AGI Technologies.	Federal Highway Administration (FHWA). "Stormwater Best Management Practices in an Ultra-Urban Setting: Selection and Monitoring – Monitoring Case Study-Streetsweeping BMP Evaluation, Port of Seattle, Washington." U.S. Department of Transportation.	Land Use = cargo container yards
Vacuum-assisted sweeper efficiency	42	77				74	NVPDC. 1992. Northern Virginia BMP Handbook: A Guide to Planning and Designing Best Management Practices in Northern Virginia. Prepared by Northern Virginia Planning District Commission (NVPDC) and Engineers and Surveyors Institute.	Federal Highway Administration (FHWA). "Stormwater Best Management Practices in an Ultra-Urban Setting: Selection and Monitoring: Fact Sheet - Street Sweepers." U.S. Department of Transportation.	
Mechanical Sweeper	55	42				40	NVPDC. 1992. Northern Virginia BMP Handbook: A Guide to Planning and Designing Best Management Practices in Northern Virginia. Prepared by Northern Virginia Planning District Commission (NVPDC) and Engineers and Surveyors Institute.	Federal Highway Administration (FHWA). "Stormwater Best Management Practices in an Ultra-Urban Setting: Selection and Monitoring: Fact Sheet - Street Sweepers." U.S. Department of Transportation.	
<b>RANGE</b>	<b>40 - 70</b>	<b>42 - 77</b>				<b>20 - 74</b>			

6.4.1 POROUS PAVEMENT

Type	Pollutant Removal % Efficiency						Primary Source	Secondary Source	Comments
	TSS	TN	NO <sub>3</sub>	NO <sub>x</sub>	TKN	TP			
Porous Pavement	80	80					Johnston Smith Consulting Limited. <i>Sustainable Urban Drainage Systems - SUDS</i> .		
Porous Pavement	95	88					Metropolitan Washington Council of Governments (MWCOG). 1983. <i>Urban Runoff in the Washington Metropolitan Area: Final Report, Urban Runoff Project, EPA Nationwide Urban Runoff Program</i> . Metropolitan Washington Council of Governments, Washington, DC.		
Porous Pavement	82	80				65	Schueler, T.R. 1987. <i>Controlling Urban Runoff: A Practical Manual for Planning and Designing Urban BMPs</i> . Metropolitan Washington Council of Governments. Department of Environmental Programs.	Winer, R. 2000. <i>National Pollutant Removal Performance Database for Stormwater Treatment Practices, 2<sup>nd</sup> Edition</i> . Center for Watershed Protection. Ellicott City, MD.	# of storms = 13; STP Size = 0.553acres; Percent efficiency calculated using mass efficiency method.
Porous Pavement	95	85				65	Schueler, T.R. 1987. <i>Controlling Urban Runoff: A Practical Manual for Planning and Designing Urban BMPs</i> . Metropolitan Washington Council of Governments. Department of Environmental Programs.	Winer, R. 2000. <i>National Pollutant Removal Performance Database for Stormwater Treatment Practices, 2<sup>nd</sup> Edition</i> . Center for Watershed Protection. Ellicott City, MD.	Percent efficiency calculated using mass efficiency method.
Porous Pavement	97					94	St. John, M. 1997. <i>Effect of Road Shoulder Treatments on Highway Runoff Quality and Quantity</i> . University of Washington.	Winer, R. 2000. <i>National Pollutant Removal Performance Database for Stormwater Treatment Practices, 2<sup>nd</sup> Edition</i> . Center for Watershed Protection. Ellicott City, MD.	"Asphalt void volume 22%"; # of storms = 9
Porous Pavement	95	82					Stormwater Manager's Resource Center (SMRC). <i>Stormwater Management Fact Sheet: Porous Pavement</i> .		
Porous Pavement	65-100	65-100				30-65	USEPA. 1999. <i>Preliminary Data Summary of Urban Stormwater BMPs</i> .		
<b>RANGE</b>	<b>65-100</b>	<b>65-100</b>				<b>30 - 94</b>			

6.4.2 INFILTRATION BASIN

Type	Pollutant Removal % Efficiency						Primary Source	Secondary Source	Comments
	TSS	TN	NO <sub>3</sub>	NO <sub>x</sub>	TKN	TP			
Infiltration Basin	95	65					Cahill Assoc. Technical BMP Manual & Infiltration Feasibility Report: Infiltration of Stormwater in Areas Underlain by Carbonate Bedrock within the Little Lehigh Creek Watershed. Nov 2002.		
Infiltration Basin	75	45 - 55				50 - 55	Schueler, T. 1987. Controlling urban runoff – a practical manual for planning and designing urban best management practices. Metropolitan Washington Council of Governments, Washington, DC.	FHWA, 1999. <i>Stormwater Best Management Practices in an Ultra-Urban Setting: Selection and Monitoring</i> . Federal Highway Administration, U.S. Department of Transportation.	Capture of 12.7 mm (0.5 in) of runoff (first flush)
Infiltration Basin	99	60 - 70				65 - 75	Schueler, T. 1987. Controlling urban runoff – a practical manual for planning and designing urban best management practices. Metropolitan Washington Council of Governments, Washington, DC.	FHWA, 1999. <i>Stormwater Best Management Practices in an Ultra-Urban Setting: Selection and Monitoring</i> . Federal Highway Administration, U.S. Department of Transportation.	Capture of 25.4 mm (1 in) of runoff
Infiltration Basin	90	55 - 60				60 - 70	Schueler, T. 1987. Controlling urban runoff – a practical manual for planning and designing urban best management practices. Metropolitan Washington Council of Governments, Washington, DC.	FHWA, 1999. <i>Stormwater Best Management Practices in an Ultra-Urban Setting: Selection and Monitoring</i> . Federal Highway Administration, U.S. Department of Transportation.	Capture of 50.8 mm (2 in) of runoff
Infiltration Basin	50-80	50-80				50-80	USEPA. Preliminary Data Summary of Urban Storm Water Best Management Practices. Aug 1999.		
<b>RANGE</b>	<b>50 - 99</b>	<b>45 - 80</b>				<b>50 - 80</b>			

6.4.3 SUBSURFACE INFILTRATION BED

Type	Pollutant Removal % Efficiency						Primary Source	Secondary Source	Comments
	TSS	TN	NO <sub>3</sub>	NO <sub>x</sub>	TKN	TP			
Subsurface Infiltration Bed	90	60	27				Cahill Assoc. Technical BMP Manual & Infiltration Feasibility Report: Infiltration of Stormwater in Areas Underlain by Carbonate Bedrock within the Little Lehigh Creek Watershed. Nov 2002.		
Subsurface Infiltration Bed	95	51				70	Chester County Conservation District. <i>Chester County Stormwater BMP Tour Guide: Infiltration Beds</i> . 2002.		
<b>RANGE</b>	<b>90 - 95</b>	<b>51 - 60</b>	<b>27</b>			<b>70</b>			

6.4.4 INFILTRATION TRENCH

Type	Pollutant Removal % Efficiency						Primary Source	Secondary Source	Comments
	TSS	TN	NO <sub>3</sub>	NO <sub>x</sub>	TKN	TP			
Infiltration Trench		3.4	100		-12.3	4.5	Kuo, C.Y., G. D. Boardman and K.T. Laptos. 1990. Phosphorous and Nitrogen Removal Efficiencies of Infiltration Trenches. Dept. of Civil Engineering. VA Polytechnic Institute and State University. Prepared for: No. VA Planning District Commission, Occoquan Technical Advisory Committee and VA State Water Control Board.	Winer, R. 2000. National Pollutant Removal Performance Database for Stormwater Treatment Practices, 2 <sup>nd</sup> Edition. Center for Watershed Protection. Ellicott City, MD.	"49.5 hours detention time", soil type = loam; Percent efficiency calculated using event mean concentration (EMC) efficiency method.
Infiltration Trench		42.3	-100		100	100	Kuo, C.Y., G. D. Boardman and K.T. Laptos. 1990. Phosphorous and Nitrogen Removal Efficiencies of Infiltration Trenches. Dept. of Civil Engineering. VA Polytechnic Institute and State University. Prepared for: No. VA Planning District Commission, Occoquan Technical Advisory Committee and VA State Water Control Board.	Winer, R. 2000. National Pollutant Removal Performance Database for Stormwater Treatment Practices, 2 <sup>nd</sup> Edition. Center for Watershed Protection. Ellicott City, MD.	"47.75 hours detention time", soil type = sandy loam; Percent efficiency calculated using event mean concentration (EMC) efficiency method.
Infiltration Trench		50.5	82		70.1	100	Kuo, C.Y., G. D. Boardman and K.T. Laptos. 1990. Phosphorous and Nitrogen Removal Efficiencies of Infiltration Trenches. Dept. of Civil Engineering. VA Polytechnic Institute and State University. Prepared for: No. VA Planning District Commission, Occoquan Technical Advisory Committee and VA State Water Control Board.	Winer, R. 2000. National Pollutant Removal Performance Database for Stormwater Treatment Practices, 2 <sup>nd</sup> Edition. Center for Watershed Protection. Ellicott City, MD.	"51.5 hours detention time", soil type = sandy; Percent efficiency calculated using event mean concentration (EMC) efficiency method.
Infiltration Trench	50-80	50-80				15-45	USEPA. <i>Preliminary Data Summary of Urban Storm Water Best Management Practices</i> . Aug 1999.		
Infiltration Trench	90	60					Schueler, T.R., 1992. A Current Assessment of Urban Best Management Practices. Metropolitan Washington Council of Governments.	United States Environmental Protection Agency (USEPA). <i>Storm Water Technology Fact Sheet: Infiltration Trench</i> (EPA 832-F-99-019). 1999.	
WQ Trench	75	45 - 55				50 - 55	Schueler, T. 1987. Controlling urban runoff – a practical manual for planning and designing urban best management practices. Metropolitan Washington Council of Governments, Washington, DC.	FHWA, 1999. <i>Stormwater Best Management Practices in an Ultra-Urban Setting: Selection and Monitoring</i> . Federal Highway Administration, U.S. Department of Transportation.	Capture of 12.7 mm (0.5 in) of runoff (first flush)
WQ Trench	90	55 - 60				55 - 60	Schueler, T. 1987. Controlling urban runoff – a practical manual for planning and designing urban best management practices. Metropolitan Washington Council of Governments, Washington, DC.	FHWA, 1999. <i>Stormwater Best Management Practices in an Ultra-Urban Setting: Selection and Monitoring</i> . Federal Highway Administration, U.S. Department of Transportation.	Capture of 50.8 mm (2 in) of runoff
<b>RANGE</b>	<b>50 - 90</b>	<b>3.4 - 80</b>	<b>(-100) - 100</b>		<b>(-12.3) - 100</b>	<b>4.5 - 100</b>			



6.4.5 RAIN GARDEN / BIORETENTION

Type	Pollutant Removal % Efficiency						Primary Source	Secondary Source	Comments
	TSS	TN	NO <sub>3</sub>	NO <sub>x</sub>	TKN	TP			
Rain Garden	53	49	16				Cahill Assoc. Technical BMP Manual & Infiltration Feasibility Report: Infiltration of Stormwater in Areas Underlain by Carbonate Bedrock within the Little Lehigh Creek Watershed. Nov 2002.		
Rain Garden	87						Davis, A.P. "Bioretention – Studies Completed by the University of Maryland" <a href="http://www.ence.umd.edu/~apdavis/Biodata.htm">http://www.ence.umd.edu/~apdavis/Biodata.htm</a> . Updated: August 27, 2002.	Low Impact Development Center. "Watershed Benefits of Bioretention Techniques". <a href="http://www.lid-stormwater.net/bioretention/bio_benefits.htm">http://www.lid-stormwater.net/bioretention/bio_benefits.htm</a> . Accessed: December 13, 2002.	
Rain Garden		57					Davis, A.P., M. Shokouhian, H. Sharma, and C. Minami. 2001. Laboratory Study of Biological Retention for Urban Stormwater Management. Water Environment Research. 73(1): 5-14.	Tetra Tech, Inc., 2003. Mecklenburg County Site Evaluation Tool Model Documentation.	
Rain Garden	91		-16			63	Hsieh, C. and A.P. Davis. Multiple-event Study of Bioretention for Treatment of Urban Storm Water Runoff. 2003. Percent efficiency calculated using mass efficiency method.		
Rain Garden	90						United States Environmental Protection Agency (USEPA). <i>Storm Water Technology Fact Sheet: Bioretention</i> (EPA 832-F-99-012). 1999.		
<b>RANGE</b>	<b>53 - 91</b>	<b>49 - 57</b>	<b>(-16) - 16</b>			<b>63</b>			

6.4.6 DRY WELL / SEEPAGE PIT

Type	Pollutant Removal % Efficiency						Primary Source	Secondary Source	Comments
	TSS	TN	NO <sub>3</sub>	NO <sub>x</sub>	TKN	TP			
Dry Well	50-80	50-80				15-45	USEPA. Preliminary Data Summary of Urban Storm Water Best Management Practices. Aug 1999.		
<b>RANGE</b>	<b>50 - 80</b>	<b>50 - 80</b>				<b>15 - 45</b>			

6.4.7 CONSTRUCTED FILTER

Type	Pollutant Removal % Efficiency						Primary Source	Secondary Source	Comments
	TSS	TN	NO <sub>3</sub>	NO <sub>x</sub>	TKN	TP			
Filtering Practice	48					-78.5	Leif, W. 1999. Compost Stormwater Filter Evaluation. Snohomish County Public County Works. Everett, WA.	Winer, R. 2000. National Pollutant Removal Performance Database for Stormwater Treatment Practices, 2 <sup>nd</sup> Edition. Center for Watershed Protection, Ellicott City, MD.	# of storms = 8; Drainage area = 0.69acres; "Filter is 12" deep"; Percent efficiency calculated using event mean concentration (EMC) efficiency method.
Organic Filter	98			32		88	Corsi, S. and S. Greb. 1997. Demonstration project of Wisconsin Department of Natural Resources, United States Geological Survey and the City of Milwaukee. Personal communication with R. Pitt. 1997. In: Multi-Chamber Treatment Train Developed for Stormwater Hot Spots. Watershed Protection Techniques. Center for Watershed Protection. February 1997.	Winer, R. 2000. National Pollutant Removal Performance Database for Stormwater Treatment Practices, 2 <sup>nd</sup> Edition. Center for Watershed Protection, Ellicott City, MD.	Land Use = City Maintenance yard (pavement); %Impervious Cover = 100%; "treatment provided for the first 1/2in of runoff. (80% of the annual water load)"; # of storms = 5; Percent efficiency calculated using event mean concentration (EMC) efficiency method.
Organic Filter	88				61	47	Lower Colorado River Authority. 1997. Innovative NPS Pollution Control Program for Lake Travis in Central Texas. LCRA.	Winer, R. 2000. National Pollutant Removal Performance Database for Stormwater Treatment Practices, 2 <sup>nd</sup> Edition. Center for Watershed Protection, Ellicott City, MD.	Land Use = Large parking lot; % Impervious Cover = 82%; "Peat/sand filter media wit surface ED. Retrofit Site. Steep Slopes. Retention Capacity 1420ft3"; # of storms = 21; Percent efficiency calculated using event mean concentration (EMC) efficiency method.
Organic Filter	90				68	73	Lower Colorado River Authority. 1997. Innovative NPS Pollution Control Program for Lake Travis in Central Texas. LCRA.	Winer, R. 2000. National Pollutant Removal Performance Database for Stormwater Treatment Practices, 2 <sup>nd</sup> Edition. Center for Watershed Protection, Ellicott City, MD.	Land Use = Large parking lot; % Impervious Cover = 82%; "Peat/sand filter media wit surface ED. Retrofit Site. Steep Slopes. Retention Capacity 1420ft3"; # of storms = 21; Percent efficiency calculated using mass efficiency method.
Organic Filter	83		14			80	Pitt, R. 1996. The Control of Toxicants at Critical Source Areas. The University of Alabama at Birmingham. In: Multi-Chamber Treatment Train Developed for Stormwater Hot Spots. Watershed Protection Techniques. Center for Watershed Protection. February 1997. 2(2): 445-449.	Winer, R. 2000. National Pollutant Removal Performance Database for Stormwater Treatment Practices, 2 <sup>nd</sup> Edition. Center for Watershed Protection, Ellicott City, MD.	Land Use = Parking Lot, vehicle service area; Treatment provided for 0.25-0.8in of rain; # of storms = 14; Percent efficiency calculated using event mean concentration (EMC) efficiency method.
Organic Filter	85					80	Pitt, R. 1997. Multi-Chamber Treatment Train Developed for Stormwater Hot Spots. Watershed Protection Techniques. Center for Watershed Protection. February 1997. 2(3): 445-449.	Winer, R. 2000. National Pollutant Removal Performance Database for Stormwater Treatment Practices, 2 <sup>nd</sup> Edition. Center for Watershed Protection, Ellicott City, MD.	Land Use = Commercial Parking Lot; # of storms = 7; Drainage area = 2.5 acres; Percent efficiency calculated using event mean concentration (EMC) efficiency method.
Organic Filter	95		-34			41	Stewart, W. 1992. Compost Stormwater Treatment System. W&H Pacific Consultants. Draft Report. Portland, OR.	Winer, R. 2000. National Pollutant Removal Performance Database for Stormwater Treatment Practices, 2 <sup>nd</sup> Edition. Center for Watershed Protection, Ellicott City, MD.	Land Use = 95%Residential, rest roadway; # of storms = 7. Drainage area = 73.9; "Compost media filter"; Percent efficiency calculated using event mean concentration (EMC) efficiency method.
Organic Media Filters	92		-145		57	49	Stormwater management. 1994. Three Year Performance Summary of Stormwater Pollutant and Treatment – 185 <sup>th</sup> Avenue, Hillsboro, Oregon. Technical Memorandum. Stormwater Management, Redland, Oregon.	US Department of Transportation, Federal Highway Administration. "Stormwater Best Management Practices in an Ultra-Urban Setting: Selection and Monitoring: Fact Sheet - Organic Media Filters."	"3-year results for CSF® Type I system"
Other Media Filters	65-100	15-45				<30	USEPA. Preliminary Data Summary of Urban Storm Water Best Management Practices. Aug 1999.		

6.4.7 CONSTRUCTED FILTER (cont.)

Type	Pollutant Removal % Efficiency						Primary Source	Secondary Source	Comments
	TSS	TN	NO <sub>3</sub>	NO <sub>x</sub>	TKN	TP			
Packed Bed Filter	81	63	75				Egan, I., S. Burroughs and I. Attaway. 1995. Packed Bed Filter. Pp. 264-274 in Proceedings Fourth Biennial Stormwater Research Conference. October 19-20. Clearwater, FL. SW Florida Water Management District.	Center for Watershed Protection. <i>Design of Stormwater Filtering Systems</i> . Dec 1996. (pg 4-8)	Percent efficiency calculated using mass efficiency method.
Sand Filter	98		64		65	66	Barrett, M., M. Keelin, J. Maima, K. Charbeneau. 1998. Evaluation of the Performance of Permanent Runoff Controls: Summary and Conclusions. Center for Transportation Research. Texas Department of Transportation. University of Texas, Austin, TX.	Winer, R. 2000. National Pollutant Removal Performance Database for Stormwater Treatment Practices, 2 <sup>nd</sup> Edition. Center for Watershed Protection, Ellicott City, MD.	Land Use = 67% Highway/33%Commercial; Drainage area = 82.95acres; # of storms = 10; Treatment Vol = first 0.5in of runoff; Percent efficiency calculated using mass efficiency method.
Sand Filter	79	47	-53.3		70.6	65.5	Heil, W., L. Stokes, L.J. Gavan and I.N. Nguyen. 1995. Assessment of the Pollutant Removal Efficiencies of Delaware Sand Filter BMPs. Final Report. Department of Transportation and Environmental Services. Alexandria, VA.	Winer, R. 2000. National Pollutant Removal Performance Database for Stormwater Treatment Practices, 2 <sup>nd</sup> Edition. Center for Watershed Protection, Ellicott City, MD.	Land Use = Parking Lot; STP Size = 477.6ft3; Drainage area = 0.7acres; # of storms = 20; "Perimeter sand filter"; Percent efficiency calculated using mass efficiency method.
Sand Filter	86	31	-5		48	19	City of Austin, TX. 1990. Removal Efficiencies of Stormwater Control Structures. Final Report. Environmental Resource Management Division.	Winer, R. 2000. National Pollutant Removal Performance Database for Stormwater Treatment Practices, 2 <sup>nd</sup> Edition. Center for Watershed Protection, Ellicott City, MD.	Land Use = Multi-family housing; Impervious Cover = 50%; # of storms = 18; Drainage area = 3.1acres; Treatment Vol = 0.5in; "Surface sand filter"; Percent efficiency calculated using mass efficiency method.
Sand Filter	87	32	-79		62	61	City of Austin, TX. 1990. Removal Efficiencies of Stormwater Control Structures. Final Report. Environmental Resource Management Division.	Winer, R. 2000. National Pollutant Removal Performance Database for Stormwater Treatment Practices, 2 <sup>nd</sup> Edition. Center for Watershed Protection, Ellicott City, MD.	Land Use = Road; Impervious Cover = 81%; # of storms = 16; Drainage area = 9.5acres; "Surface sand filter"; Percent efficiency calculated using mass efficiency method.
Sand Filter	75	44	-13		64	59	City of Austin, TX. 1990. Removal Efficiencies of Stormwater Control Structures. Final Report. Environmental Resource Management Division.	Winer, R. 2000. National Pollutant Removal Performance Database for Stormwater Treatment Practices, 2 <sup>nd</sup> Edition. Center for Watershed Protection, Ellicott City, MD.	Land Use = Mail 86%; Commercial Cover = 86%; # of storms = 18; Drainage area = 79acres; Treatment Vol = 0.5in; STP Size = 3.5acre/ft; "Surface sand filter"; Percent efficiency calculated using mass efficiency method.
Sand Filter	92	71	23		90	80	City of Austin, TX. 1990. Removal Efficiencies of Stormwater Control Structures. Final Report. Environmental Resource Management Division.	Winer, R. 2000. National Pollutant Removal Performance Database for Stormwater Treatment Practices, 2 <sup>nd</sup> Edition. Center for Watershed Protection, Ellicott City, MD.	Impervious Cover = 68%; # of storms = 17; Drainage area = 50acres; "Surface sand filter"; Percent efficiency calculated using mass efficiency method.
Sand Filters	70	21					United States Environmental Protection Agency (USEPA). <i>Storm Water Technology Fact Sheet: Sand Filters</i> (EPA 832-F-99-007) 1999.		
Sand Filter	78	27	-100		57	27	Welborn, C. and J. Veenhuis. 1987. Effects of Runoff Controls on the Quantity and Quality of Urban Runoff in Two Locations in Austin, TX. USGS Water Resources Investigations Report. 87-1004.	Winer, R. 2000. National Pollutant Removal Performance Database for Stormwater Treatment Practices, 2 <sup>nd</sup> Edition. Center for Watershed Protection, Ellicott City, MD.	Land Use = Commercial; Drainage area = 80acres; # of storms = 22; "Surface sand filter"; Percent efficiency calculated using mass efficiency method.
Surface Sand Filters	50-80	<30				50-80	USEPA. Preliminary Data Summary of Urban Storm Water Best Management Practices. Aug 1999.		
<b>RANGE</b>	<b>48 - 100</b>	<b>21 - 71</b>	<b>(-145) - 75</b>	<b>32</b>	<b>48 - 90</b>	<b>(-78.5) - 88</b>			

6.4.8 VEGETATED SWALE

Type	Pollutant Removal % Efficiency						Primary Source	Secondary Source	Comments
	TSS	TN	NO <sub>3</sub>	NO <sub>x</sub>	TKN	TP			
100 Foot Swale	60						Delaware DNREC and Brandywine Conservancy. <i>Conservation Design for Stormwater Management</i> . Sep. 1997.		
200 Foot Swale	83						Delaware DNREC and Brandywine Conservancy. <i>Conservation Design for Stormwater Management</i> . Sep. 1997.		
Drainage Channel	65		11				Dorman, M.E., J. Hartigan, R.F. Steg and T. Quasebarth. 1989. Retention, Detention and Overland Flow for Pollutant Removal from Highway Stormwater Runoff. Vol. 1. Research Report. Federal Highway Administration. <i>Final Report</i> . 1989.		
Drainage Channel	33						Oakland R. An evaluation of Stormwater Pollutant Removal Through Grassed Swale Treatment. Proceedings of the International Symposium of Urban Hydrology, Hydraulics and Sediment Control. 1992.		
Drainage Channel	31	37					Ocoquan Watershed Monitoring Laboratory (OWML). Final Report. Washington Area NURP Report. VPI&SU. Metropolitan Washington Council of Governments. Manassas, VA. 1983.		
Drainage Channel		13	11				Yoursel, Y. et al. Best Management Practices – Removal of Highway Contaminants by Roadside Swales. Final Report. University of Central Florida. Florida Department of Transportation. Orlando, FL. 1985.		
Dry Swale	87	84	80			83	Harper, H. 1988. Effects of Stormwater Management Systems on Groundwater Quality. Final Report. Environmental Research and Design, Inc. Prepared for Florida Department of Environmental Regulation.	Winer, R. 2000. National Pollutant Removal Performance Database for Stormwater Treatment Practices, 2 <sup>nd</sup> Edition. Center for Watershed Protection, Ellicott City, MD.	Land Use = Interstate highway, 70% Impervious; # of storms = 16; "Infiltration Rate = 13.4in/hour. Time of Concentration = 45min" Drainage area = 0.83acres; Percent efficiency calculated using mass efficiency method.
Dry Swale	99	99	99			99	Kercher, W.C., J.C. Landon and R. Massarelli. 1983. Grassy Swales Prove Cost-Effective for Water Pollution Control. Public Works. Vol. 16: 53-55.	Winer, R. 2000. National Pollutant Removal Performance Database for Stormwater Treatment Practices, 2 <sup>nd</sup> Edition. Center for Watershed Protection, Ellicott City, MD.	Land Use = Residential; Soil Type = Sandy; # of storms = 13; drainage area = 14 acres; slope = 2%; Percent efficiency calculated using mass efficiency method.
Grass Channel	60			-25		45	Seattle Metro and Washington Department of Ecology. 1992. Biofiltration Swale Performance: Recommendations and Design Considerations. Publication No. 657. Water Pollution Control Department, Seattle Washington.	Winer, R. 2000. National Pollutant Removal Performance Database for Stormwater Treatment Practices, 2 <sup>nd</sup> Edition. Center for Watershed Protection, Ellicott City, MD.	Land Use = Major roadway, residences, parks; impervious Cover = 47%; "grass channel design. 10 minute residence time for design storm; Drainage area = 15.5acres; slope = 4%; "Length 200ft. 5ft wide"; Percent efficiency calculated using event mean concentration (EMC) efficiency method.
Grass Channel	67.8			31.4		4.5	Goldberg. 1993. Dayton Avenue Swale Biofiltration Study. Seattle Engineering Department. Seattle, WA.	Winer, R. 2000. National Pollutant Removal Performance Database for Stormwater Treatment Practices, 2 <sup>nd</sup> Edition. Center for Watershed Protection, Ellicott City, MD.	%Impervious Cover = 20; "600ft long grass channel"; # of storms = 8; Drainage area = 90acres; Percent efficiency calculated using event mean concentration (EMC) efficiency method.
Grass Channel	83			-25		29	Seattle Metro and Washington Department of Ecology. 1992. Biofiltration Swale Performance: Recommendations and Design Considerations. Publication No. 657. Water Pollution Control Department, Seattle Washington.	Winer, R. 2000. National Pollutant Removal Performance Database for Stormwater Treatment Practices, 2 <sup>nd</sup> Edition. Center for Watershed Protection, Ellicott City, MD.	Land Use = Major roadway, residences, parks; impervious Cover = 47%; "grass channel design. 10 minute residence time for design storm; Drainage area = 15.5acres; slope = 4%; "Length 200ft. 5ft wide"; Percent efficiency calculated using event mean concentration (EMC) efficiency method.

6.4.8 VEGETATED SWALE (cont.)

Type	Pollutant Removal % Efficiency						Primary Source	Secondary Source	Comments
	TSS	TN	NO <sub>3</sub>	NO <sub>x</sub>	TKN	TP			
Grassed Swales	30-65	15-45				15-45	USEPA, 1999. Preliminary Data Summary of Urban Stormwater BMPs. Yousef, Y.A., M.P. Waniesta, H.H. Harper, D.B. Pearce, and R.D. Tolbert. 1985. Best Management Practices Removal of Highway Contaminants by Roadside Swales. Final Report. Florida Department of Transportation, Tallahassee.		
Swales		24	-21				USEPA, 1999. Preliminary Data Summary of Urban Stormwater BMPs. Yousef, Y.A., M.P. Waniesta, H.H. Harper, D.B. Pearce, and R.D. Tolbert. 1985. Best Management Practices Removal of Highway Contaminants by Roadside Swales. Final Report. Florida Department of Transportation, Tallahassee.		
Swales		27	-2				USEPA, 1999. Preliminary Data Summary of Urban Stormwater BMPs. Yousef, Y.A., M.P. Waniesta, H.H. Harper, D.B. Pearce, and R.D. Tolbert. 1985. Best Management Practices Removal of Highway Contaminants by Roadside Swales. Final Report. Florida Department of Transportation, Tallahassee.		
Swales		39	48				USEPA, 1999. Preliminary Data Summary of Urban Stormwater BMPs. Yousef, Y.A., M.P. Waniesta, H.H. Harper, D.B. Pearce, and R.D. Tolbert. 1985. Best Management Practices Removal of Highway Contaminants by Roadside Swales. Final Report. Florida Department of Transportation, Tallahassee.		
Swales		61	57				USEPA, 1999. Preliminary Data Summary of Urban Stormwater BMPs. Yousef, Y.A., M.P. Waniesta, H.H. Harper, D.B. Pearce, and R.D. Tolbert. 1985. Best Management Practices Removal of Highway Contaminants by Roadside Swales. Final Report. Florida Department of Transportation, Tallahassee.		
Swales		73	67				USEPA, 1999. Preliminary Data Summary of Urban Stormwater BMPs. Yousef, Y.A., M.P. Waniesta, H.H. Harper, D.B. Pearce, and R.D. Tolbert. 1985. Best Management Practices Removal of Highway Contaminants by Roadside Swales. Final Report. Florida Department of Transportation, Tallahassee.		
Swales		100	100				USEPA, 1999. Preliminary Data Summary of Urban Stormwater BMPs. Yousef, Y.A., M.P. Waniesta, H.H. Harper, D.B. Pearce, and R.D. Tolbert. 1985. Best Management Practices Removal of Highway Contaminants by Roadside Swales. Final Report. Florida Department of Transportation, Tallahassee.		
Vegetated Filter Strip	87		50			44	Barrett, M.E. et al. Evaluation of the Performance of Permanent Runoff controls: Summary and Conclusions. Center for Research in Water Resources, University of Texas at Austin. Austin, TX: Nov. 1997.		Site 1; Treatment Length = 7.5 to 8.8m; slope = .73%; vegetation = buffalo grass; higher traffic than site 2; Percent efficiency calculated using event mean concentration (EMC) efficiency method.
Vegetated Filter Strip	85		23			34	Barrett, M.E. et al. Evaluation of the Performance of Permanent Runoff controls: Summary and Conclusions. Center for Research in Water Resources, University of Texas at Austin. Austin, TX: Nov. 1997.		Site 2; Treatment Length = 7.8 to 8.1m; slope = 1.7%; vegetation = mixed; lower traffic than site 1; Percent efficiency calculated using event mean concentration (EMC) efficiency method.

6.4.8 VEGETATED SWALE (cont.)

Type	Pollutant Removal % Efficiency						Primary Source	Secondary Source	Comments
	TSS	TN	NO <sub>3</sub>	NO <sub>x</sub>	TKN	TP			
Vegetated Swales	81		38				United States Environmental Protection Agency (USEPA). <i>Storm Water Technology Fact Sheet: Vegetated Swales</i> (EPA 832-F-99-006) 1999		
Wet Swale	81	40	52			17	Harper, H. 1988. Effects of Stormwater Management Systems on Groundwater Quality. Final Report. Environmental Research and Design, Inc. Prepared for Florida Department of Environmental Regulation.	Winer, R. 2000. National Pollutant Removal Performance Database for Stormwater Treatment Practices, 2 <sup>nd</sup> Edition. Center for Watershed Protection. Ellicott City, MD.	Length= 210ft; Land Use = Interstate highway (100% Impervious); Treatment Vol= 2year critical velocity, 10 year capacity; Soil Type = saturated sandy; # of storms = 11; drainage area = 1.17 acres; slope = 1.8%; Percent efficiency calculated using mass efficiency method
WQ Swale	98		45		48	18	Dorman, W.E., J. Hartigan, R.F. Steg and T. Quasebarth. 1989. Retention, Detention and Overland Flow for Pollutant Removal from Highway Stormwater Runoff. Vol. 1. Research Report. Federal Highway Administration. FHWA/RD-89-002	Winer, R. 2000. National Pollutant Removal Performance Database for Stormwater Treatment Practices, 2 <sup>nd</sup> Edition. Center for Watershed Protection. Ellicott City, MD.	Land use = highway, Impervious cover = 63%, soil type = sandy; length 185'; Age of facility = 5years
WQ Swale	80						Wang, I., D. Spyridakis, B. Mar and R. Horner. 1981. Transport, deposition, and control of heavy metals in highway runoff. FHWA-WA-RD-39-10. Dept. of Civil Engineering, University of Washington. Seattle, WA	Center for Watershed Protection. <i>Design of Stormwater Filtering Systems</i> . Dec 1996. (pg 4-19)	
<b>RANGE</b>	<b>30 - 99</b>	<b>13 - 100</b>	<b>(-21) - 100</b>	<b>(-25) - 31.4</b>	<b>48</b>	<b>4.5 - 99</b>			

6.4.9 VEGETATED FILTER STRIP

Type	Pollutant Removal % Efficiency						Primary Source	Secondary Source	Comments
	TSS	TN	NO <sub>3</sub>	NO <sub>x</sub>	TKN	TP			
15 Foot Grass Filter Strip	70						Klapproth, J.C. and J.E. Johnson. <i>Understanding the Science Behind Riparian Forest Buffers: Effects on Water Quality</i> . Virginia Tech. Oct 2000		
30 Foot Grass Filter Strip	84						Klapproth, J.C. and J.E. Johnson. <i>Understanding the Science Behind Riparian Forest Buffers: Effects on Water Quality</i> . Virginia Tech. Oct 2000		
75 Foot Filter Strip	54		-27				Center for Watershed Protection. <i>Design of Stormwater Filtering Systems</i> . Dec 1996. (pg 4-26)		
150 Foot Filter Strip	84		20				Center for Watershed Protection. <i>Design of Stormwater Filtering Systems</i> . Dec 1996. (pg 4-26)		
Grass/Grass-Forest Filter Strip	60-90						Klapproth, J.C. and J.E. Johnson. <i>Understanding the Science Behind Riparian Forest Buffers: Effects on Water Quality</i> . Virginia Tech. Oct 2000		
Vegetated Filter Strip	70	30	0				Center for Watershed Protection. <i>Design of Stormwater Filtering Systems</i> . Dec 1996. (pg 4-33)		
Vegetated Filter Strip	75	45	22				Cahill Assoc. Technical BMP Manual & Infiltration Feasibility Report: Infiltration of Stormwater in Areas Underlain by Carbonate Bedrock within the Little Lehigh Creek Watershed. Nov 2002		
<b>RANGE</b>	<b>54 - 90</b>	<b>30 - 45</b>	<b>(-27) - 22</b>						

6.6.1 CONSTRUCTED WETLAND

Type	Pollutant Removal % Efficiency						Primary Source	Secondary Source	Comments
	TSS	TN	NO <sub>3</sub>	NO <sub>x</sub>	TKN	TP			
Constructed Wetlands	50-80	<30				15-45	USEPA. 1999. Preliminary Data Summary of Urban Stormwater BMPs. Athanas C. and C. Stevenson. 1990.		
Extended Detention Wetland	24			35		16	Nutrient Removal from Stormwater Runoff by a Vegetated Collection Pond - The Mays Chapel Wetland Basin Project. Prepared for the City of Baltimore, Department of Public Works, Bureau of Water and Wastewater, Water Quality Management Office.	Winer, R. 2000. National Pollutant Removal Performance Database for Stormwater Treatment Practices, 2nd Edition. Center for Watershed Protection. Ellicott City, MD.	Treatment volume = 0.1in/acre; Drainage area = 97acres
Extended Detention Wetland	76				25	54	Barten, J.M. 1983. Treatment of Stormwater Runoff Using Aquatic Plants. The Use of Wetlands for Controlling Stormwater Pollution. Strecker, E.W. J.M. Kersnar and E.E. Dris coll (Eds.). Woodward-Clyde Consultants. Portland, Oregon. Prepared for the USEPA, Region V, Water Division, Watershed Management Unit. EPA/600 February	Winer, R. 2000. National Pollutant Removal Performance Database for Stormwater Treatment Practices, 2nd Edition. Center for Watershed Protection. Ellicott City, MD.	Treatment volume = 0.15in/acre; Drainage area = 1070acres
Extended Detention Wetland	62		23		40	24	Oberts, G.L., F.J. Wotzka and J.A. Hartsoe. 1989. The water Quality Performance of Select Urban Runoff Treatment Systems. Prepared for the Legislative Commision on Minnesota Resources. Metropolitan Council. St. Paul, MN. Publication No. 500-89-0629	Winer, R. 2000. National Pollutant Removal Performance Database for Stormwater Treatment Practices, 2nd Edition. Center for Watershed Protection. Ellicott City, MD.	# of storms = 10; Treatment volume = 0.1in/acre; Drainage area = 413acres
Extended Detention Wetland	62	-2.1	1.2			8.3	Occoquan Watershed Monitoring Laboratory and George Mason Univeristy. 1990. Final Report: The Evaluation of a Created Wetland as an Urban Best Management Practice. Prepared for the Northern Virginia Soil and Water Conservation District	Winer, R. 2000. National Pollutant Removal Performance Database for Stormwater Treatment Practices, 2nd Edition. Center for Watershed Protection. Ellicott City, MD.	Impervious Cover = 30%; # of storms = 23; Treatment volume = 0.1in/acre; Drainage area = 40acres; "Data collected from Large storms >0.1watershed inch. Large storms overwhelm capacity of wetlands to remove nutrients."
Extended Detention Wetland	93	76	68		81	76	Occoquan Watershed Monitoring Laboratory and George Mason Univeristy. 1990. Final Report: The Evaluation of a Created Wetland as an Urban Best Management Practice. Prepared for the Northern Virginia Soil and Water Conservation District	Winer, R. 2000. National Pollutant Removal Performance Database for Stormwater Treatment Practices, 2nd Edition. Center for Watershed Protection. Ellicott City, MD.	Impervious Cover = 30%; # of storms = 23; Treatment volume = 0.1in/acre; Drainage area = 40acres; "Data collected from Small storms <0.1watershed inch."; Percent efficiency calculated using mass efficiency method.
Shallow Marsh	65	22.8	54.9	54.5		39.1	Athanas, C. and C. Stevenson. 1991. The Use of Artificial Wetlands in Treating Stormwater Runoff. Prepared for the Maryland Sediment and Stormwater Administration. Maryland Department of the Environment	Winer, R. 2000. National Pollutant Removal Performance Database for Stormwater Treatment Practices, 2nd Edition. Center for Watershed Protection. Ellicott City, MD.	Land Use = High School roof, parking lot, athletic; Surface area of wetland = 0.6acres; Treatment volume = 0.5in/acre; Drainage area = 16acres; Percent efficiency calculated using mass efficiency method.
Shallow Marsh	37.5	13	25.5		11.5	47.5	Blackburn, R., P.L. Pimentel and G.E. French. 1986. Treament of Stormwater Runoff Using Aquatic Plants. The Use of Wetlands for Controlling Stormwater Pollution. Strecker, E.W. J.M. Kersnar and E.E. Dris coll (Eds.). Woodward-Clyde Consultants. Portland, Oregon. Prepared for the USEPA, Region V, Water Division, Watershed Management	Winer, R. 2000. National Pollutant Removal Performance Database for Stormwater Treatment Practices, 2nd Edition. Center for Watershed Protection. Ellicott City, MD.	Land use = Golf Course; Size of Wetland = 296acres; # of storms = 72; Treatment volume = 1in; Drainage area = 2340acres; Percent efficiency calculated using event mean concentration (EMC) efficiency method.
Shallow Marsh	86	46		94	34	70	Carr, D. and B. Rushton. 1995. Integrating a Herbaceous Wetland into Stormwater Management. Stormwater Research Program. Southwest Florida Water Management District, Brooksville	Winer, R. 2000. National Pollutant Removal Performance Database for Stormwater Treatment Practices, 2nd Edition. Center for Watershed Protection. Ellicott City, MD.	# of storms = 81; Drainage area = 15.3; STP size = 3acres; Percent efficiency calculated using mass efficiency method.

6.6.1 CONSTRUCTED WETLAND (cont.)

Type	Pollutant Removal % Efficiency						Primary Source	Secondary Source	Comments
	TSS	TN	NO <sub>3</sub>	NO <sub>x</sub>	TKN	TP			
Shallow Marsh	82.9	-1.6	80.2			7	Harper, H.H., M.P. Wamensie, B.M. Fries and D.M. Baker. 1986. The Use of Wetlands for Controlling Stormwater Pollution. Strecker, E.W. J.M. Kersnar and E.E. Dris coll (Eds.). Woodward-Clyde Consultants. Portland, Oregon. Prepared for the USEPA, Region V, Water Division, Watershed Management Unit. EPA/600/5-86-002	Winer, R. 2000. National Pollutant Removal Performance Database for Stormwater Treatment Practices, 2nd Edition. Center for Watershed Protection, Ellicott City, MD.	"Runoff enters through a small shallow canal. This is a NATURAL WETLAND." Land Use = Large Residential Community; Treatment Volume = 1.08in/acre; Drainage area = 55.4acres; STP size = 2.47acres; Percent efficiency calculated using mass efficiency method.
Shallow Marsh	85.5		67			75	Hey, D.L., A.L. Kenimer and K.R. Barrett. 1994. Water Quality Improvement by Four Experimental Wetlands Ecological Engineering Vol. 3: 381-397.	Winer, R. 2000. National Pollutant Removal Performance Database for Stormwater Treatment Practices, 2nd Edition. Center for Watershed Protection, Ellicott City, MD.	wetland 4. Land Use = 80%Agriculture, 20%Urban; "5 - 8.6 acre wetland. Max depth 5ft. Subject to low flow conditions (2.8-6.3 in/week)" Drainage area = 128000acres; Percent efficiency calculated using mass efficiency method.
Shallow Marsh	87		82.5			77.5	Hey, D.L., A.L. Kenimer and K.R. Barrett. 1994. Water Quality Improvement by Four Experimental Wetlands Ecological Engineering Vol. 3: 381-397.	Winer, R. 2000. National Pollutant Removal Performance Database for Stormwater Treatment Practices, 2nd Edition. Center for Watershed Protection, Ellicott City, MD.	Wetland 1. Land Use = 80%Agriculture, 20%Urban; "5 - 8.6 acre wetland. Max depth 5ft. Subject to high flow conditions (13.4 - 38.2 in/week)" Drainage area = 128000acres; Percent efficiency calculated using mass efficiency method.
Shallow Marsh	95.5		86			87	Hey, D.L., A.L. Kenimer and K.R. Barrett. 1994. Water Quality Improvement by Four Experimental Wetlands Ecological Engineering Vol. 3: 381-397.	Winer, R. 2000. National Pollutant Removal Performance Database for Stormwater Treatment Practices, 2nd Edition. Center for Watershed Protection, Ellicott City, MD.	Wetland 2. Land Use = 80%Agriculture, 20%Urban; "5 - 8.6 acre wetland. Max depth 5ft. Subject to high flow conditions (13.4 - 38.2 in/week)" Drainage area = 128000acres; Percent efficiency calculated using mass efficiency method.
Shallow Marsh	99.5		99			99.5	Hey, D.L., A.L. Kenimer and K.R. Barrett. 1994. Water Quality Improvement by Four Experimental Wetlands Ecological Engineering Vol. 3: 381-397.	Winer, R. 2000. National Pollutant Removal Performance Database for Stormwater Treatment Practices, 2nd Edition. Center for Watershed Protection, Ellicott City, MD.	Wetland 3. Land Use = 80%Agriculture, 20%Urban; "5 - 8.6 acre wetland. Max depth 5ft. Subject to low flow conditions (2.8-6.3 in/week)" Drainage area = 128000acres; Percent efficiency calculated using mass efficiency method.
Shallow Marsh	94					78	Hickok, E.A., M.C. Hannaman and N.C. Wenck. 1977. Urban Runoff Treatment Methods. Volume 1: Non-structural Wetland Treatment. The Use of Wetlands for Controlling Stormwater Pollution. Strecker, E.W. J.M. Kersnar and E.E. Dris coll (Eds.). Woodward-Clyde Consultants. Portland, Oregon. Prepared for the USEPA, Region V, Water Division, Watershed Management	Winer, R. 2000. National Pollutant Removal Performance Database for Stormwater Treatment Practices, 2nd Edition. Center for Watershed Protection, Ellicott City, MD.	Land use = 47%Residential. "This is a NATURAL WETLAND." STP size = 7.6acres. Treatment volume = 1.25 in/acre; Drainage area = 73.2acres;
Shallow Marsh	20			67		33	Koon, J. 1995. Evaluation of Water Quality Ponds and Swales in the Issaquah/East Lake Sammamish Basins. King County Surface Water Management and Washington Department of Ecology. Seattle, WA.	Winer, R. 2000. National Pollutant Removal Performance Database for Stormwater Treatment Practices, 2nd Edition. Center for Watershed Protection, Ellicott City, MD.	Two cell wetland; first cell 2ft deep pool with emergent wetlands; second cell is free." # of storms = 5; Design Basis = 2 & 25 year quantity control only; Drainage area = 7.7acres; Percent efficiency calculated using event mean concentration (EMC) efficiency method.
Shallow Marsh		54	78				Phipps, R.G. and W.G. Crumpton. 1994. Factors Affecting Nitrogen Loss in Experimental Wetlands With Different Hydrologic Loads. Ecological Engineering. December 1994. Vol. 3(4): 399-408	Winer, R. 2000. National Pollutant Removal Performance Database for Stormwater Treatment Practices, 2nd Edition. Center for Watershed Protection, Ellicott City, MD.	"High Hydraulic Loading." Average Detention Time = 12days; Land Use = 80%Ag; STP size = 5.9acres, avg 24in deep; Drainage area = 128000acres; Percent efficiency calculated using mass efficiency method.
Shallow Marsh		59	84				Phipps, R.G. and W.G. Crumpton. 1994. Factors Affecting Nitrogen Loss in Experimental Wetlands With Different Hydrologic Loads. Ecological Engineering. December 1994. Vol. 3(4): 399-408	Winer, R. 2000. National Pollutant Removal Performance Database for Stormwater Treatment Practices, 2nd Edition. Center for Watershed Protection, Ellicott City, MD.	"High Hydraulic Loading." Average Detention Time = 13days; Land Use = 80%Ag; STP size = 4.7acres, avg 28in deep; Drainage area = 128000acres; Percent efficiency calculated using mass efficiency method.



6.6.1 CONSTRUCTED WETLAND (cont.)

Type	Pollutant Removal % Efficiency						Primary Source	Secondary Source	Comments
	TSS	TN	NO <sub>3</sub>	NO <sub>x</sub>	TKN	TP			
Shallow Marsh		75	95				Phipps, R.G. and W.G. Crumpton. 1994. Factors Affecting Nitrogen Loss in Experimental Wetlands With Different Hydrologic Loads. Ecological Engineering. December 1994. Vol. 3(4): 399-408	Winer, R. 2000. National Pollutant Removal Performance Database for Stormwater Treatment Practices, 2nd Edition. Center for Watershed Protection, Ellicott City, MD.	"Low Hydraulic Loading." Average Detention Time = 95days; Land Use = 80%Ag; STP size = 5.9acres, avg 28in deep; Drainage area = 128000acres; Percent efficiency calculated using mass efficiency method.
Stormwater Wetland	67	28					Center for Watershed Protection, 1997. National Pollutant Removal Performance Database for Stormwater Best Management Practices. Prepared for the Chesapeake Research Consortium.	United States Environmental Protection Agency (USEPA). Storm Water Technology Fact Sheet: Storm Water Wetlands (EPA 832-F-99-025) 1999.	
Stormwater Wetland	56		20			-2	Rehner et al., 1990. In: The Use of Wetlands for Controlling Stormwater Pollution. Strecker, E.W. J.M. Kersnar and E.E. Driscoll (Eds.). Woodward-Clyde Consultants. Portland, Oregon. Prepared for the USEPA, Region V, Water Division, Watershed Management Unit. EPA 600/5-90-008	Winer, R. 2000. National Pollutant Removal Performance Database for Stormwater Treatment Practices, 2nd Edition. Center for Watershed Protection, Ellicott City, MD.	# of storms = 13; Treatment Volume = 0.03in/acre; Drainage Area = 214.8acres; "Channelization reduced effectiveness."
Stormwater Wetland	14		4			-2	Rehner et al., 1990. In: The Use of Wetlands for Controlling Stormwater Pollution. Strecker, E.W. J.M. Kersnar and E.E. Driscoll (Eds.). Woodward-Clyde Consultants. Portland, Oregon. Prepared for the USEPA, Region V, Water Division, Watershed Management Unit. EPA 600/5-90-008	Winer, R. 2000. National Pollutant Removal Performance Database for Stormwater Treatment Practices, 2nd Edition. Center for Watershed Protection, Ellicott City, MD.	# of storms = 13; Treatment Volume = 0.01in/acre; Drainage Area = 461.7acres; "Channelization reduced effectiveness."
Stormwater Wetland	57			67		57	Rushton, B. and C. Dye. 1993. An In-Depth Analysis of a Wet Detention Stormwater System. Southwest Florida Water Management District. Brooksville, FL.	Winer, R. 2000. National Pollutant Removal Performance Database for Stormwater Treatment Practices, 2nd Edition. Center for Watershed Protection, Ellicott City, MD.	# of storms = 25; Drainage Area = 6acres; Surface Area = 0.32acres, Max Depth = 18ft; Runoff conveyed by 200ft drainage channel; BMP approx. 3-5 years old.; Percent efficiency calculated using event mean concentration (EMC) efficiency method.
Stormwater Wetland	-1.32					14.86	Yu, S; G. Fitch, and T. Earles. 1998. Constructed Wetlands for Stormwater Management. Virginia Transportation Research Council. Charlottesville, VA.	Winer, R. 2000. National Pollutant Removal Performance Database for Stormwater Treatment Practices, 2nd Edition. Center for Watershed Protection, Ellicott City, MD.	Land Use = parking lot and highway; # of storms = 5; STP size = 0.7acres; Percent efficiency calculated using event mean concentration (EMC) efficiency method.
Stormwater Wetland	30.1					27.46	Yu, S; G. Fitch, and T. Earles. 1998. Constructed Wetlands for Stormwater Management. Virginia Transportation Research Council. Charlottesville, VA.	Winer, R. 2000. National Pollutant Removal Performance Database for Stormwater Treatment Practices, 2nd Edition. Center for Watershed Protection, Ellicott City, MD.	Land Use = parking lot and highway; # of storms = 5; STP size = 0.7acres; Percent efficiency calculated using mass efficiency method.
Stormwater Wetland	52.02					68.09	Yu, S; G. Fitch, and T. Earles. 1998. Constructed Wetlands for Stormwater Management. Virginia Transportation Research Council. Charlottesville, VA.	Winer, R. 2000. National Pollutant Removal Performance Database for Stormwater Treatment Practices, 2nd Edition. Center for Watershed Protection, Ellicott City, MD.	Land Use = Highway; # of storms = 13; STP size = 5acres; Percent efficiency calculated using mass efficiency method.
Stormwater Wetland	56.96					68.61	Yu, S; G. Fitch, and T. Earles. 1998. Constructed Wetlands for Stormwater Management. Virginia Transportation Research Council. Charlottesville, VA.	Winer, R. 2000. National Pollutant Removal Performance Database for Stormwater Treatment Practices, 2nd Edition. Center for Watershed Protection, Ellicott City, MD.	Land Use = Highway; # of storms = 13; STP size = 5acres; Percent efficiency calculated using event mean concentration (EMC) efficiency method.
<b>RANGE</b>	<b>(-1.32) - 99.5</b>	<b>(-2.1) - 76</b>	<b>1.2 - 99</b>	<b>35 - 94</b>	<b>11.5 - 81</b>	<b>(-2) - 95.5</b>			

6.6.2 WET POND / RETENTION BASIN

Type	Pollutant Removal % Efficiency						Primary Source	Secondary Source	Comments
	TSS	TN	NO <sub>3</sub>	NO <sub>x</sub>	TKN	TP			
Retention Basin	50-80	30-65				30-65	USEPA. 1999. Preliminary Data Summary of Urban Stormwater BMPs. Borden, K.C., J.L. Dorn, J.B. Summan and S.K. Liehr. 1996. Draft Report. Evaluation of Ponds and Wetlands For Protection of Public Water Supplies. Water Resources Research Institute of the University of North Carolina. Department of Civil Engineering. North Carolina State University. Raleigh, NC		
Wet Extended Detention Pond	60.4	16	18.2			46.2	City of Austin, TX. 1991. Design Guidelines for Water Quality Control Basins. Public Works Department. Austin, TX.	Winer, R. 2000. National Pollutant Removal Performance Database for Stormwater Treatment Practices, 2 <sup>nd</sup> Edition. Center for Watershed Protection. Ellicott City, MD.	Land Use = Dairy Farms, woodland; Impervious Cover = 16%; Percent efficiency calculated using mass efficiency method.
Wet Extended Detention Pond	54	39	45		26	46	Fellows, D., W. Liang, S. Ristic, and M. Thompson. 1999. Performance Assessment of MTOs Rouge River, Highway 40, Stormwater Management Pond. SWAMP. Ontario Ministry of Environment and Energy.	Winer, R. 2000. National Pollutant Removal Performance Database for Stormwater Treatment Practices, 2 <sup>nd</sup> Edition. Center for Watershed Protection. Ellicott City, MD.	Impervious cover = 39%
Wet Extended Detention Pond	87			24	59	79	Lower Colorado River Authority. 1997. Innovative NPS Pollution Control Program for Lake Travis in Central Texas. LCRA.	Winer, R. 2000. National Pollutant Removal Performance Database for Stormwater Treatment Practices, 2 <sup>nd</sup> Edition. Center for Watershed Protection. Ellicott City, MD.	Land Use = Mostly residential; Impervious Cover = 34%; Percent efficiency calculated using mass efficiency method.
Wet Extended Detention Pond	83	55		85	52	52	Ontario Ministry of the Environment. 1991. Stormwater Quality Best Management Practices. Marshall Macklin Monaghan Limited. Toronto, Ontario.	Winer, R. 2000. National Pollutant Removal Performance Database for Stormwater Treatment Practices, 2 <sup>nd</sup> Edition. Center for Watershed Protection. Ellicott City, MD.	Land Use = parking lot/commercial
Wet Extended Detention Pond	98	54				79	Rushton, B., C. Miller and H. Hull. 1995. The Effect of Residence Time on the Efficiency of a Wet Detention Stormwater Treatment Pond. Presented at the 31st Annual Conference and Symposium in Urban Areas. November 10-12, 1995. Houston, TX.	Winer, R. 2000. National Pollutant Removal Performance Database for Stormwater Treatment Practices, 2 <sup>nd</sup> Edition. Center for Watershed Protection. Ellicott City, MD.	
Wet Extended Detention Pond	61			63		56	Rushton, B., C. Miller and H. Hull. 1995. The Effect of Residence Time on the Efficiency of a Wet Detention Stormwater Treatment Pond. Presented at the 31st Annual Conference and Symposium in Urban Areas. November 10-12, 1995. Houston, TX.	Winer, R. 2000. National Pollutant Removal Performance Database for Stormwater Treatment Practices, 2 <sup>nd</sup> Edition. Center for Watershed Protection. Ellicott City, MD.	Impervious Cover = 30%
Wet Extended Detention Pond	67			61		57	Rushton, B., C. Miller and H. Hull. 1995. The Effect of Residence Time on the Efficiency of a Wet Detention Stormwater Treatment Pond. Presented at the 31st Annual Conference and Symposium in Urban Areas. November 10-12, 1995. Houston, TX.	Winer, R. 2000. National Pollutant Removal Performance Database for Stormwater Treatment Practices, 2 <sup>nd</sup> Edition. Center for Watershed Protection. Ellicott City, MD.	Impervious Cover = 30%; Residence time = 5 days
Wet Extended Detention Pond	69	28		67	25	75	Rushton, B., C. Miller and H. Hull. 1995. The Effect of Residence Time on the Efficiency of a Wet Detention Stormwater Treatment Pond. Presented at the 31st Annual Conference and Symposium in Urban Areas. November 10-12, 1995. Houston, TX.	Winer, R. 2000. National Pollutant Removal Performance Database for Stormwater Treatment Practices, 2 <sup>nd</sup> Edition. Center for Watershed Protection. Ellicott City, MD.	Impervious Cover = 30%; Residence time = 5 days
Wet Extended Detention Pond	71			64		62	Rushton, B., C. Miller and H. Hull. 1995. The Effect of Residence Time on the Efficiency of a Wet Detention Stormwater Treatment Pond. Presented at the 31st Annual Conference and Symposium in Urban Areas. November 10-12, 1995. Houston, TX.	Winer, R. 2000. National Pollutant Removal Performance Database for Stormwater Treatment Practices, 2 <sup>nd</sup> Edition. Center for Watershed Protection. Ellicott City, MD.	Impervious Cover = 30%
Wet Extended Detention Pond	94			88		90	Rushton, B., C. Miller and H. Hull. 1995. The Effect of Residence Time on the Efficiency of a Wet Detention Stormwater Treatment Pond. Presented at the 31st Annual Conference and Symposium in Urban Areas. November 10-12, 1995. Houston, TX.	Winer, R. 2000. National Pollutant Removal Performance Database for Stormwater Treatment Practices, 2 <sup>nd</sup> Edition. Center for Watershed Protection. Ellicott City, MD.	Impervious Cover = 30%; Land Use = rooftops, parking lots, vehicle storage; Residence Time = 14days

6.6.2 WET POND / RETENTION BASIN (cont.)

Type	Pollutant Removal % Efficiency						Primary Source	Secondary Source	Comments
	TSS	TN	NO <sub>3</sub>	NO <sub>x</sub>	TKN	TP			
Wet Extended Detention Pond	95			88		89	Rushton, B., C. Miller and H. Hill. 1995. The Effect of Residence Time on the Efficiency of a Wet Detention Stormwater Treatment Pond. Presented at the 31st Annual Conference and Symposium in Urban Areas. November 10-12, 1995. Houston, TX.	Winer, R. 2000. National Pollutant Removal Performance Database for Stormwater Treatment Practices, 2 <sup>nd</sup> Edition. Center for Watershed Protection, Ellicott City, MD.	Impervious Cover = 30%; Land Use = rooftops, parking lots, vehicle storage; Residence Time = 14days
Wet Extended Detention Pond	76		75		65	70	Yi, S.C. and D.E. Benemourok. 1998. Field Testing of Selected Urban BMPs in Critical Water Issues and Computer Applications. In Proceedings of the 15th Annual Water Resources Conference. American Society of Civil Engineers, New York, NY.	Federal Highway Administration (FHWA). "Stormwater Best Management Practices in an Ultra-Urban Setting: Selection and Monitoring: Fact Sheet -Detention Ponds." U.S. Department of Transportation.	
Wet Pond	46		36		14	37	Nayak, R.N. 1990. Removal Efficiencies of Stormwater Control Structures. Environmental Resources Management Division, Environmental and Conservation Services Department, City of Austin, Austin, TX.	Federal Highway Administration (FHWA). "Stormwater Best Management Practices in an Ultra-Urban Setting: Selection and Monitoring: Fact Sheet -Detention Ponds." U.S. Department of Transportation.	
Wet Pond	94		64		44	81	City of Austin. 1995. Urban Drain Characterization of Stormwater Pollution for Austin, Texas Area. Environmental Resources Management Division, Environmental and Conservation Services Department, City of Austin, Austin, TX.	Federal Highway Administration (FHWA). "Stormwater Best Management Practices in an Ultra-Urban Setting: Selection and Monitoring: Fact Sheet -Detention Ponds." U.S. Department of Transportation.	
Wet Pond	68	12		93	-31	55	Cullum, M. 1984. Volume II Evaluation of the Water Management System at a Single Family Residential Site: Water Quality Analysis for Selected Storm Events at Timbercreek Subdivision in Boca Raton, FL. South Florida Water Management District.	Winer, R. 2000. National Pollutant Removal Performance Database for Stormwater Treatment Practices, 2 <sup>nd</sup> Edition. Center for Watershed Protection, Ellicott City, MD.	Land Use = single family residential; Soil type = group A; Treatment Vol = 3.11in/acre; Percent efficiency calculated using event mean concentration (EMC) efficiency method.
Wet Pond	54			97	68	69	Dorman, M.E., J. Hartigan, R.F. Steg, and T. Quasebarth. 1989. Retention, Detention and Overland Flow for Pollutant Removal from Highway Stormwater Runoff. Vol. 1. Research Report. Federal Highway Administration. FHWA RD 90/202.	Winer, R. 2000. National Pollutant Removal Performance Database for Stormwater Treatment Practices, 2 <sup>nd</sup> Edition. Center for Watershed Protection, Ellicott City, MD.	
Wet Pond	65			61	23	25	Dorman, M.E., J. Hartigan, R.F. Steg, and T. Quasebarth. 1989. Retention, Detention and Overland Flow for Pollutant Removal from Highway Stormwater Runoff. Vol. 1. Research Report. Federal Highway Administration. FHWA RD 90/202.	Winer, R. 2000. National Pollutant Removal Performance Database for Stormwater Treatment Practices, 2 <sup>nd</sup> Edition. Center for Watershed Protection, Ellicott City, MD.	Land Use = Highway; Percent efficiency calculated using mass efficiency method.
Wet Pond	32	6	-1		7	12	Discoli, E.D. 1983. Performance of Detention Basins for Control of Urban Runoff Quality. Presented at the 1983 International Symposium on Urban Hydrology, Hydraulics and Sedimentation Control. University of Kentucky. Lexington, KY.	Winer, R. 2000. National Pollutant Removal Performance Database for Stormwater Treatment Practices, 2 <sup>nd</sup> Edition. Center for Watershed Protection, Ellicott City, MD.	
Wet Pond	32		7		14	18	Discoli, E.D. 1983. Performance of Detention Basins for Control of Urban Runoff Quality. Presented at the 1983 International Symposium on Urban Hydrology, Hydraulics and Sedimentation Control. University of Kentucky. Lexington, KY.	Winer, R. 2000. National Pollutant Removal Performance Database for Stormwater Treatment Practices, 2 <sup>nd</sup> Edition. Center for Watershed Protection, Ellicott City, MD.	

6.6.2 WET POND / RETENTION BASIN (cont.)

Type	Pollutant Removal % Efficiency						Primary Source	Secondary Source	Comments
	TSS	TN	NO <sub>3</sub>	NO <sub>x</sub>	TKN	TP			
Wet Pond	60					45	Driscoll, E.D. 1983. Performance of Detention Basins for Control of Urban Runoff Quality. Presented at the 1983 International Symposium on Urban Hydrology, Hydraulics and Sedimentation Control. University of Kentucky. Lexington, KY.	Winer, R. 2000. National Pollutant Removal Performance Database for Stormwater Treatment Practices, 2 <sup>nd</sup> Edition. Center for Watershed Protection. Ellicott City, MD.	
Wet Pond	81	37			27	54	Driscoll, E.D. 1983. Performance of Detention Basins for Control of Urban Runoff Quality. Presented at the 1983 International Symposium on Urban Hydrology, Hydraulics and Sedimentation Control. University of Kentucky. Lexington, KY.	Winer, R. 2000. National Pollutant Removal Performance Database for Stormwater Treatment Practices, 2 <sup>nd</sup> Edition. Center for Watershed Protection. Ellicott City, MD.	
Wet Pond	84					34	Driscoll, E.D. 1983. Performance of Detention Basins for Control of Urban Runoff Quality. Presented at the 1983 International Symposium on Urban Hydrology, Hydraulics and Sedimentation Control. University of Kentucky. Lexington, KY.	Winer, R. 2000. National Pollutant Removal Performance Database for Stormwater Treatment Practices, 2 <sup>nd</sup> Edition. Center for Watershed Protection. Ellicott City, MD.	
Wet Pond	91	62	66		60	79	Driscoll, E.D. 1983. Performance of Detention Basins for Control of Urban Runoff Quality. Presented at the 1983 International Symposium on Urban Hydrology, Hydraulics and Sedimentation Control. University of Kentucky. Lexington, KY.	Winer, R. 2000. National Pollutant Removal Performance Database for Stormwater Treatment Practices, 2 <sup>nd</sup> Edition. Center for Watershed Protection. Ellicott City, MD.	
Wet Pond	54	16		24		30	Gall, S.W. The effects of Flow-Path Modifications on Urban Water-Quality Constituent Retention in Urban Stormwater Detention Pond and Wetland System, Orlando, Florida. Florida Department of Transportation, Orlando, FL, 1996.	Winer, R. 2000. National Pollutant Removal Performance Database for Stormwater Treatment Practices, 2 <sup>nd</sup> Edition. Center for Watershed Protection. Ellicott City, MD.	"Pond was modified to increase detention time and was previously studied by Martin and Smoot (1988)." Percent efficiency calculated using event mean concentration (EMC) efficiency method.
Wet Pond	85		92		26	54	Harper, H.H., and J.L. Herr. 1993. Treatment Efficiencies of Detention with Filtration Systems. Environmental Research and Design, Inc. Orlando, FL.	Claytor, Richard, and T. Schueler, 1996. Design of Stormwater Filtering Systems. Center for Watershed Protection. Silver Spring, MD.	
Wet Pond	7			23		40	Kantrowitz, I. and W. Woodham. 1995. Efficiency of a Stormwater Detention Pond in Reducing Loads of Chemical and Physical Constituents in Urban Streamflow, Pinellas County, Florida. U.S. Geological Survey. Water Resources Investigations Report: 94-1217. Tallahassee, FL.	Winer, R. 2000. National Pollutant Removal Performance Database for Stormwater Treatment Practices, 2 <sup>nd</sup> Edition. Center for Watershed Protection. Ellicott City, MD.	"Very large online wet pond with detention" Percent efficiency calculated using event mean concentration (EMC) efficiency method.
Wet Pond	45			36		45	Kantrowitz, I. and W. Woodham. 1995. Efficiency of a Stormwater Detention Pond in Reducing Loads of Chemical and Physical Constituents in Urban Streamflow, Pinellas County, Florida. U.S. Geological Survey. Water Resources Investigations Report: 94-1217. Tallahassee, FL.	Winer, R. 2000. National Pollutant Removal Performance Database for Stormwater Treatment Practices, 2 <sup>nd</sup> Edition. Center for Watershed Protection. Ellicott City, MD.	"Very large online wet pond with detention"
Wet Pond	80			62	0	80	Liang, W. 1996. Performance Assessment of an Off-Line Stormwater Management Pond. Ontario Ministry of Environment and Energy.	Winer, R. 2000. National Pollutant Removal Performance Database for Stormwater Treatment Practices, 2 <sup>nd</sup> Edition. Center for Watershed Protection. Ellicott City, MD.	Land Use = Residential; Impervious Cover = 55%; Residential cover = 100%; Soil Type = clay till and clay loam

6.6.2 WET POND / RETENTION BASIN (cont.)

Type	Pollutant Removal % Efficiency						Primary Source	Secondary Source	Comments
	TSS	TN	NO <sub>3</sub>	NO <sub>x</sub>	TKN	TP			
Wet Pond	85						NC DENR, 1999. North Carolina Stormwater Best Management Practices Manual. Division of Water Quality.		
Wet Pond	85	30	24		31	48	Oberts, G.L., P.J. Wotzka and J.A. Hartsoe. 1989. The Water Quality Performance of Select Urban Runoff Treatment Systems. Prepared for the Legislative Commission on Minnesota Resources. Metropolitan Council. St. Paul, MN. Publication No. 500-89-062a	Winer, R. 2000. National Pollutant Removal Performance Database for Stormwater Treatment Practices, 2 <sup>nd</sup> Edition. Center for Watershed Protection. Ellicott City, MD.	Age of Facility = 4years; Percent efficiency calculated using mass efficiency method.
Wet Pond	90	41	10		50	61	Oberts, G.L., P.J. Wotzka and J.A. Hartsoe. 1989. The Water Quality Performance of Select Urban Runoff Treatment Systems. Prepared for the Legislative Commission on Minnesota Resources. Metropolitan Council. St. Paul, MN. Publication No. 500-89-062a	Winer, R. 2000. National Pollutant Removal Performance Database for Stormwater Treatment Practices, 2 <sup>nd</sup> Edition. Center for Watershed Protection. Ellicott City, MD.	Age of Facility = 6years
Wet Pond	-33.3	32				39	Occoquan Watershed Monitoring Laboratory. 1983. Final Report: Metropolitan Washington Urban Runoff Project. Prepared for the Metropolitan Washington Council of Governments. Manassas, VA	Winer, R. 2000. National Pollutant Removal Performance Database for Stormwater Treatment Practices, 2 <sup>nd</sup> Edition. Center for Watershed Protection. Ellicott City, MD.	Land Use = Medium density residential; Impervious cover = 25%
Wet Pond	85	34				86	Occoquan Watershed Monitoring Laboratory. 1983. Final Report: Metropolitan Washington Urban Runoff Project. Prepared for the Metropolitan Washington Council of Governments. Manassas, VA	Winer, R. 2000. National Pollutant Removal Performance Database for Stormwater Treatment Practices, 2 <sup>nd</sup> Edition. Center for Watershed Protection. Ellicott City, MD.	Land Use = Agriculture
Wet Pond	80-90						United States Environmental Protection Agency (USEPA). <i>Storm Water Technology Fact Sheet: Wet Detention Ponds</i> (EPA 832-F-99-048) 1999		
Wet Pond	62				21	36	Wu, J. 1989. Evaluation of Detention Basin Performance in the Piedmont region of North Carolina. North Carolina Water Resources Research Institute. Report No. 89-248. Raleigh, NC.	Winer, R. 2000. National Pollutant Removal Performance Database for Stormwater Treatment Practices, 2 <sup>nd</sup> Edition. Center for Watershed Protection. Ellicott City, MD.	Land use = multi-unit housing, woodland; Impervious cover = 38%; Soil type = clay; Surface area = 3.3 acres, Mean pond depth = 3.8'; Volume=12.3acre feet; "No geese present." Percent efficiency calculated using mass
Wet Pond	93				32	45	Wu, J. 1989. Evaluation of Detention Basin Performance in the Piedmont region of North Carolina. North Carolina Water Resources Research Institute. Report No. 89-248. Raleigh, NC.	Winer, R. 2000. National Pollutant Removal Performance Database for Stormwater Treatment Practices, 2 <sup>nd</sup> Edition. Center for Watershed Protection. Ellicott City, MD.	Land use = mixed residential, impervious cover = 46%; Residential = 100%; Pond = 4.9 acres; Mean pond depth = 8'; Volume = 38.8 acre feet; "Geese population present increase N and P values." Percent efficiency calculated using mass efficiency method.
<b>RANGE</b>	<b>(-33.3) - 98</b>	<b>6 - 65</b>	<b>(-1) - 92</b>	<b>23 - 97</b>	<b>(-31) - 68</b>	<b>12 - 90</b>			

6.6.3 DRY EXTENDED DETENTION BASIN

Type	Pollutant Removal % Efficiency						Primary Source	Secondary Source	Comments
	TSS	TN	NO <sub>3</sub>	NO <sub>x</sub>	TKN	TP			
Dry Detention Basins	30-65	15-45				15-45	USEPA. 1999. Preliminary Data Summary of Urban Stormwater BMPs.		
Dry Detention Pond	96		64		44	81	Yu, S.L., M. Barnes, R.J. Kight, and S.L. Laio. 1994. Field Test of Stormwater Best Management Practices in Watershed Wastewater Treatment. In Proceedings of the 1994 National Conference on Environmental Engineering. American Society of Civil Engineers, Baltimore, MD.	Federal Highway Administration (FHWA). "Stormwater Best Management Practices in an Ultra-Urban Setting: Selection and Monitoring: Fact Sheet -Detention Ponds." U.S. Department of Transportation.	"Removal efficiencies based on mass loading."
Dry Extended Detention Pond	87		-10			26	Baltimore Department of Public Works. 1989. Detention Basin Retrofit Project and Monitoring Study Results. Water Quality Management Office. Baltimore, MD.	Winer, R. 2000. National Pollutant Removal Performance Database for Stormwater Treatment Practices, 2 <sup>nd</sup> Edition. Center for Watershed Protection, Ellicott City, MD.	# of storms = 9; Treatment Vol = 0.50in/acre; drainage area = 16.8acres
Dry Extended Detention Pond	89		-3		26	51	Barrett, M.E. et al., 1997. Evaluation of the Performance of Permanent Runoff Controls: Summary and Conclusions, CRWR Online Report 97-3. Center for Research in Water Resources, Bureau of Engineering Research, The University of Texas at Austin, TX.		Land Use = Highway; Percent efficiency calculated using mass efficiency method.
Dry Extended Detention Pond	30	35	52			18	City of Austin, TX. 1991. Design Guidelines for Water Quality Control Basins. Public Works Department. Austin, TX.	Winer, R. 2000. National Pollutant Removal Performance Database for Stormwater Treatment Practices, 2 <sup>nd</sup> Edition. Center for Watershed Protection, Ellicott City, MD.	# of storms = 17; Treatment Vol = 0.50in/acre; drainage area= 28 acres
Dry Extended Detention Pond	47					21	Miller, T. 1987. Appraisal of Storm-Water Quality Near Salem, Oregon. US Geological Survey. Water Resources Report 87-4064.	Winer, R. 2000. National Pollutant Removal Performance Database for Stormwater Treatment Practices, 2 <sup>nd</sup> Edition. Center for Watershed Protection, Ellicott City, MD.	Impervious = 53%; Residential = 39%; Commercial = 38%; Industrial = 1%; # of storms = 11; soil = HSG-C; Drainage area = 512acres
Dry Extended Detention Pond	51.5	42.5				48	Occoquan Watershed Monitoring Laboratory. 1987. Final Report: London Commons Extended Detention Facility. Urban BMP Research and Demonstration Project. Virginia Tech University, Blacksburg, VA.	Winer, R. 2000. National Pollutant Removal Performance Database for Stormwater Treatment Practices, 2 <sup>nd</sup> Edition. Center for Watershed Protection, Ellicott City, MD.	# of storms = 27; Treatment Vol = 0.22in/acre; detention provided up to 20hours; drainage area = 11.4 acres
Dry Extended Detention Pond	70	24			30	13	Schueler, T.R. and W. Heinrich. 1988. Design of Extended Detention Wet Pond Systems. In: Design of Urban Runoff Quality Controls. L.L. Roesner, B. Urbonas and M.B. Sonnen (Eds.). American Society of Civil Engineers. New York, NY.	Winer, R. 2000. National Pollutant Removal Performance Database for Stormwater Treatment Practices, 2 <sup>nd</sup> Edition. Center for Watershed Protection, Ellicott City, MD.	# of storms = 25; Treatment Vol = 0.30in/acre; drainage area = 34acres
Dry Extended Detention Pond	71	26	-2			14	Stanley, D. 1994. An Evaluation of the Pollutant Removal of a Demonstration Urban Stormwater Detention Pond. Albermarle-Pamlico Estuary Study. APES Report 94-07.	Winer, R. 2000. National Pollutant Removal Performance Database for Stormwater Treatment Practices, 2 <sup>nd</sup> Edition. Center for Watershed Protection, Ellicott City, MD.	Impervious Cover = 31%; Land Use = Residential/Commercial; # of storms = 8; Treatment Vol = 72hours detention for the first 0.5in; drainage area = 200acres; Percent efficiency calculated using mass efficiency method.
<b>RANGE</b>	<b>30 - 96</b>	<b>15 - 45</b>	<b>(-10) - 64</b>		<b>26 - 44</b>	<b>13 - 81</b>			

6.6.4 WATER QUALITY FILTER

Type	Pollutant Removal % Efficiency						Primary Source	Secondary Source	Comments
	TSS	TN	NO <sub>3</sub>	NO <sub>x</sub>	TKN	TP			
Catch Basins	60 - 97						Aronson, G. et al. Evaluation of Catch Basin Performance for Urban Stormwater Pollution Control. EPA-600/2-83-043	Stormwater Manager's Resource Center (SMRC). <i>Pollution Prevention Fact Sheet: Catch Basins.</i>	Only very small storms used
Catch Basins	10 - 25					5 - 10	Pitt, R. and G. Shawley. 1982. <i>A Demonstration of Non-Point Pollution Management on Castro Valley Creek</i> , Alameda County Flood Control District (Hayward, California) and U.S. EPA, Washington, DC	Stormwater Manager's Resource Center (SMRC). <i>Pollution Prevention Fact Sheet: Catch Basins.</i>	
Catch Basins	32						Pitt, R. et al. 1997. <i>Guidance Manual for Integrated Wet Weather Flow Collection and Treatment Systems for Newly Urbanized Areas</i> . US EPA. Office of Research and Development. Cincinnati, OH	Stormwater Manager's Resource Center (SMRC). <i>Pollution Prevention Fact Sheet: Catch Basins.</i>	
<b>RANGE</b>	<b>10 - 97</b>					<b>5 - 10</b>			

6.7.1 RIPARIAN BUFFER RESTORATION

Type	Pollutant Removal % Efficiency						Primary Source	Secondary Source	Comments
	TSS	TN	NO <sub>3</sub>	NO <sub>x</sub>	TKN	TP			
25' buffer	57	27				34	Desbonnet, A., P. Pogue, V. Lee, and N. Wolff. 1994. <i>Vegetated Buffers in the Coastal Zone: An Annotated Review and Bibliography</i> . Coastal Resources Center, University of RI	Schueler, T. 1995. <i>Site Planning for Urban Stream Protection</i> . The Center for Watershed Protection.	
50' buffer	62	31				38	Desbonnet, A., P. Pogue, V. Lee, and N. Wolff. 1994. <i>Vegetated Buffers in the Coastal Zone: An Annotated Review and Bibliography</i> . Coastal Resources Center, University of RI	Schueler, T. 1995. <i>Site Planning for Urban Stream Protection</i> . The Center for Watershed Protection.	
75' buffer	65	33				41	Desbonnet, A., P. Pogue, V. Lee, and N. Wolff. 1994. <i>Vegetated Buffers in the Coastal Zone: An Annotated Review and Bibliography</i> . Coastal Resources Center, University of RI	Schueler, T. 1995. <i>Site Planning for Urban Stream Protection</i> . The Center for Watershed Protection.	
100' buffer	67	34				43	Desbonnet, A., P. Pogue, V. Lee, and N. Wolff. 1994. <i>Vegetated Buffers in the Coastal Zone: An Annotated Review and Bibliography</i> . Coastal Resources Center, University of RI	Schueler, T. 1995. <i>Site Planning for Urban Stream Protection</i> . The Center for Watershed Protection.	
200' buffer	72	38				47	Desbonnet, A., P. Pogue, V. Lee, and N. Wolff. 1994. <i>Vegetated Buffers in the Coastal Zone: An Annotated Review and Bibliography</i> . Coastal Resources Center, University of RI	Schueler, T. 1995. <i>Site Planning for Urban Stream Protection</i> . The Center for Watershed Protection.	
Deciduous Forest Buffers		68					Lowrance, R., R. Todd, J. Fall, Jr., O. Hendrickson, Jr., R. Leonard, and L. Asmussen. 1984b. <i>Riparian forests as nutrient filters in agricultural watersheds</i> . <i>Bioscience</i> 34:374-377	Klapproth, J.C. and J.E. Johnson. <i>Understanding the Science Behind Riparian Forest Buffers: Effects on Water Quality</i> . Virginia Tech. Oct 2000.	
Hardwood Riparian Area	84-90						Cooper, J.R., J.W. Gilliam, R.B. Daniels, and W.P. Robarge. 1987. <i>Riparian areas as filters for agricultural sediment</i> . <i>Soil Science Society of America Journal</i> 51:416-420	Klapproth, J.C. and J.E. Johnson. <i>Understanding the Science Behind Riparian Forest Buffers: Effects on Water Quality</i> . Virginia Tech. Oct 2000.	
Riparian Buffer			95				Jordan, T.E., D.L. Correll, and D.E. Weller. 1993. <i>Nutrient interception by a riparian forest receiving inputs from adjacent croplands</i> . <i>Journal of Environmental Quality</i> 22:467-473	Klapproth, J.C. and J.E. Johnson. <i>Understanding the Science Behind Riparian Forest Buffers: Effects on Water Quality</i> . Virginia Tech. Oct 2000.	

6.7.1 RIPARIAN BUFFER RESTORATION (con't.)

Type	Pollutant Removal % Efficiency						Primary Source	Secondary Source	Comments
	TSS	TN	NO <sub>3</sub>	NO <sub>x</sub>	TKN	TP			
Riparian Buffer		89					Peterjohn, W. I. and D.L. Correll. 1984. Nutrient dynamics in an agricultural watershed: observations on the role of a riparian forest. <i>Ecology</i> 65:1466-1475	Klapproth, J.C. and J.E. Johnson. <i>Understanding the Science Behind Riparian Forest Buffers: Effects on Water Quality</i> . Virginia Tech. Oct 2000.	
Riparian Buffer			48				Snyder, N.J., S. Mostaghimi, D.F. Berry, R.B. Reneau, E.P. Smith. 1995. Evaluation of a riparian wetland as a naturally occurring decontamination zone. Pages 259-262. In: <i>Clean Water, Clean Environment - 21st Century</i> . Volume III: Practices, Systems, and Adoption. Proceedings of a conference March 5-8, 1995 Kansas City, Mo. American Society of Agricultural	Klapproth, J.C. and J.E. Johnson. <i>Understanding the Science Behind Riparian Forest Buffers: Effects on Water Quality</i> . Virginia Tech. Oct 2000.	
Switchgrass Buffer (7.1m)	95	80	62			78	Lee, K.H., T.M. Isenhart, and R.C. Schultz. "Sediment and nutrient removal in an established multi-species riparian buffer," <i>Journal of Water Conservation</i> , Vol. 58, No. 1	SWCS, 2003. Soil and Water Conservation Society.	
Switchgrass/Woody Buffer (16.3m)	97	94	85			91	Lee, K.H., T.M. Isenhart, and R.C. Schultz. "Sediment and nutrient removal in an established multi-species riparian buffer," <i>Journal of Water Conservation</i> , Vol. 58, No. 1	SWCS, 2003. Soil and Water Conservation Society.	
<b>RANGE</b>	<b>57 - 97</b>	<b>27 - 94</b>	<b>48 - 95</b>			<b>34 - 91</b>			



## **BMP Pollutant Removal Efficiencies- Inflow vs. Outflow Pollutant concentrations**

6.4.4 INFILTRATION TRENCH

\*\*UNITS ARE IN MG/L UNLESS OTHERWISE NOTED\*\*

Type	TSS		TN		NO <sub>3</sub>		NO <sub>x</sub>		TKN		TP		Primary Source	Secondary Source	Comments
	Inflow	Outflow	Inflow	Outflow	Inflow	Outflow	Inflow	Outflow	Inflow	Outflow	Inflow	Outflow			
Infiltration Trench			6.59	3.8	0.95	3.8					0.24	0	Kuo, C.Y., G. D. Boardman and K.T. Laptos. 1990. Phosphorous and Nitrogen Removal Efficiencies of Infiltration Trenches. Dept. of Civil Engineering. VA Polytechnic Institute and State University. Prepared for: No. VA Planning District Commission, Occoquan Technical Advisory Committee and VA State	Winer, R. 2000. National Pollutant Removal Performance Database for Stormwater Treatment Practices, 2 <sup>nd</sup> Edition. Center for Watershed Protection. Ellicott City, MD.	"47.75 hours detention time", soil type = sandy loam
Infiltration Trench			5.38	5.2	0.75	0					0.66	0.63	Kuo, C.Y., G. D. Boardman and K.T. Laptos. 1990. Phosphorous and Nitrogen Removal Efficiencies of Infiltration Trenches. Dept. of Civil Engineering. VA Polytechnic Institute and State University. Prepared for: No. VA Planning District Commission, Occoquan Technical Advisory Committee and VA State	Winer, R. 2000. National Pollutant Removal Performance Database for Stormwater Treatment Practices, 2 <sup>nd</sup> Edition. Center for Watershed Protection. Ellicott City, MD.	"49.5 hours detention time", soil type = loam
Infiltration Trench			2.04	1.01	0.5	0.09					0.2	0	Kuo, C.Y., G. D. Boardman and K.T. Laptos. 1990. Phosphorous and Nitrogen Removal Efficiencies of Infiltration Trenches. Dept. of Civil Engineering. VA Polytechnic Institute and State University. Prepared for: No. VA Planning District Commission, Occoquan Technical Advisory Committee and VA State	Winer, R. 2000. National Pollutant Removal Performance Database for Stormwater Treatment Practices, 2 <sup>nd</sup> Edition. Center for Watershed Protection. Ellicott City, MD.	"51.5 hours detention time", soil type = sandy

6.4.5 RAIN GARDEN

\*\*UNITS ARE IN MG/L UNLESS OTHERWISE NOTED\*\*

Type	TSS		TN		NO <sub>3</sub>		NO <sub>x</sub>		TKN		TP		Primary Source	Secondary Source	Comments
	Inflow	Outflow	Inflow	Outflow	Inflow	Outflow	Inflow	Outflow	Inflow	Outflow	Inflow	Outflow			
Rain Garden	87.4g	7.6g			1.60g	1.85g					1.62g	0.60g	Hsien, C. and A.P. Davis. Multiple-event Study of Bioretention for Treatment of Urban Storm Water Runoff. 2003. Percent efficiency calculated using mass efficiency method.		

6.4.7 CONSTRUCTED FILTER

\*\*UNITS ARE IN MG/L UNLESS OTHERWISE NOTED\*\*

Type	TSS		TN		NO <sub>3</sub>		NO <sub>x</sub>		TKN		TP		Primary Source	Secondary Source	Comments
	Inflow	Outflow	Inflow	Outflow	Inflow	Outflow	Inflow	Outflow	Inflow	Outflow	Inflow	Outflow			
Organic Filter	35.5	16											Leif, W. 1999. Compost Stormwater Filter Evaluation. Snohomish County Public County Works. Everett, WA.	Winer, R. 2000. National Pollutant Removal Performance Database for Stormwater Treatment Practices, 2 <sup>nd</sup> Edition. Center for Watershed Protection. Ellicott City, MD.	# of storms = 8; Drainage area = 0.69acres; "Filter is 12" deep";
Organic Filter	49	6	1.76	0.858			0.481	0.552					Lower Colorado River Authority. 1997. Innovative NPS Pollution Control Program for Lake Travis in Central Texas. LCRA.	Winer, R. 2000. National Pollutant Removal Performance Database for Stormwater Treatment Practices, 2 <sup>nd</sup> Edition. Center for Watershed Protection. Ellicott City, MD.	Land Use = Large parking lot; % Impervious Cover = 82%; "Peat/sand filter media wit surface ED. Retrofit Site. Steep Slopes. Retention Capacity 1420ft <sup>3</sup> "; # of storms = 21
Organic Filter	39.95	4.47					0.3	0.4					Stewart, W. 1992. Compost Stormwater Treatment System. W&H Pacific Consultants. Draft Report. Portland, OR.	Winer, R. 2000. National Pollutant Removal Performance Database for Stormwater Treatment Practices, 2 <sup>nd</sup> Edition. Center for Watershed Protection. Ellicott City, MD.	Land Use = 95%Residential, rest roadway; # of storms = 7, Drainage area = 73.9; "Compost media filter"
Sand Filter	204	3.5	2.83	1.065			1.24	0.474					Barrett, M.; M. Koblin; J. Malina; R. Charbeneau. 1998. Evaluation of the Performance of Permanent Runoff Controls: Summary and Conclusions. Center for Transportation Research. Texas Department of Transportation. University of	Winer, R. 2000. National Pollutant Removal Performance Database for Stormwater Treatment Practices, 2 <sup>nd</sup> Edition. Center for Watershed Protection. Ellicott City, MD.	Land Use = 67% Highway/33%Commercial; Drainage area = 82.95acres; # of storms = 10; Treatment Vol = first 0.5in of runoff
Sand Filter	76.2	16.84	7.93	3.8			1.27	1.99					Deit, W.; L. Stokes, L.J. Gavan and T.N. Nguyen. 1995. Assessment of the Pollutant Removal Efficiencies of Delaware Sand Filter BMPs. Final Report. Department of Transportation and Environmental Services. Maryland, MD.	Winer, R. 2000. National Pollutant Removal Performance Database for Stormwater Treatment Practices, 2 <sup>nd</sup> Edition. Center for Watershed Protection. Ellicott City, MD.	Land Use = Parking Lot; STP Size = 477.6ft <sup>3</sup> ; Drainage area = 0.7acres; # of storms = 20; "Perimeter sand filter"

6.4.8 VEGETATED SWALE

\*\*UNITS ARE IN MG/L UNLESS OTHERWISE NOTED\*\*

Type	TSS		TN		NO <sub>3</sub>		NO <sub>x</sub>		TKN		TP		Primary Source	Secondary Source	Comments	
	Inflow	Outflow	Inflow	Outflow	Inflow	Outflow	Inflow	Outflow	Inflow	Outflow	Inflow	Outflow				
Dry Swale	50	4					0.549	0.347	0.83	0.74	0.218	0.304	Dorman, M.E., J. Hartigan, R.F. Steg and T. Quasebarth. 1989. Retention, Detention and Overland Flow for Pollutant Removal from Highway Stormwater Runoff. Vol. 1. Research Report. Federal Highway Administration.	Winer, R. 2000. National Pollutant Removal Performance Database for Stormwater Treatment Practices, 2 <sup>nd</sup> Edition. Center for Watershed Protection. Ellicott City, MD.	Land use = highway, Impervious cover = 63%, soil type = sandy; length 185'; Age of facility = 5years	
Grass Channel	47	15.13					1.24	0.85			0.228	0.22	Goldberg. 1993. Dayton Avenue Swale Biofiltration Study. Seattle Engineering Department. Seattle, WA.	Winer, R. 2000. National Pollutant Removal Performance Database for Stormwater Treatment Practices, 2 <sup>nd</sup> Edition. Center for Watershed Protection. Ellicott City, MD.	%Impervious Cover = 20; "600ft long grass channel"; # of storms = 8; Drainage area = 90acres	
Grass Channel	94.67	14					0.35	0.77			0.2	0.14	Seattle Metro and Washington Department of Ecology. 1992. Biofiltration Swale Performance: Recommendations and Design Considerations. Publication No. 657. Water Pollution Control Department, Seattle	Winer, R. 2000. National Pollutant Removal Performance Database for Stormwater Treatment Practices, 2 <sup>nd</sup> Edition. Center for Watershed Protection. Ellicott City, MD.	Land Use = Major roadway, residences, parks; impervious Cover = 47%; "grass channel design. 10 minute residence time for design storm; Drainage area = 15.5acres; slope = 4%; "Length 200ft. 5ft wide" Soil Type = glacial till	
Grass Channel	128	30					0.26	0.31			0.1	0.06	Seattle Metro and Washington Department of Ecology. 1992. Biofiltration Swale Performance: Recommendations and Design Considerations. Publication No. 657. Water Pollution Control Department, Seattle	Winer, R. 2000. National Pollutant Removal Performance Database for Stormwater Treatment Practices, 2 <sup>nd</sup> Edition. Center for Watershed Protection. Ellicott City, MD.	Land Use = Major roadway, residences, parks; impervious Cover = 47%; "grass channel design. 10 minute residence time for design storm; Drainage area = 15.5acres; slope = 4%; "Length 100ft. 5ft wide" Soil Type = glacial till	
Vegetated Swale	157	21			0.91	0.46					2.17	1.46	0.55	0.31	Barrett, M.L. et al. Evaluation of the Performance of Permanent Runoff controls: Summary and Conclusions. Center for Research in Water Resources, University of Texas at Austin. Austin, TX: Nov. 1997.	Site 1; Treatment Length = 7.5 to 8.8m; slope = .73%; vegetation = buffalo grass; higher traffic than site 2; Percent efficiency calculated using event mean concentration (EMC) efficiency method.
Vegetated Swale	190	29			1.27	0.97					2.61	1.45	0.24	0.16	Barrett, M.L. et al. Evaluation of the Performance of Permanent Runoff controls: Summary and Conclusions. Center for Research in Water Resources, University of Texas at Austin. Austin, TX: Nov. 1997.	Site 2; Treatment Length = 7.8 to 8.1m; slope = 1.7%; vegetation = mixed; lower traffic than site 1; Percent efficiency calculated using event mean concentration (EMC) efficiency method.

6.4.9 VEGETATED FILTER STRIP

\*\*UNITS ARE IN MG/L UNLESS OTHERWISE NOTED\*\*

Type	TSS		TN		NO <sub>3</sub>		NO <sub>x</sub>		TKN		TP		Primary Source	Secondary Source	Comments
	Inflow	Outflow	Inflow	Outflow	Inflow	Outflow	Inflow	Outflow	Inflow	Outflow	Inflow	Outflow			
Vegetated Filter Strip	157	21			0.91	0.46							Barrett, M.L. et al. Evaluation of the Performance of Permanent Runoff controls: Summary and Conclusions. Center for Research in Water Resources, University of Texas at Austin. Austin, TX: Nov. 1997.	Site 1; Treatment Length = 7.5 to 8.8m; slope = .73%; vegetation = buffalo grass; higher traffic than site 2; Percent efficiency calculated using event mean concentration (EMC) efficiency method.	
Vegetated Filter Strip	190	29			1.27	0.97							Barrett, M.L. et al. Evaluation of the Performance of Permanent Runoff controls: Summary and Conclusions. Center for Research in Water Resources, University of Texas at Austin. Austin, TX: Nov. 1997.	Site 2; Treatment Length = 7.8 to 8.1m; slope = 1.7%; vegetation = mixed; lower traffic than site 1; Percent efficiency calculated using event mean concentration (EMC) efficiency method.	

6.6.1 CONSTRUCTED WETLAND

\*\*UNITS ARE MG/L UNLESS OTHERWISE NOTED\*\*

Type	TSS		TN		NO <sub>3</sub>		NO <sub>x</sub>		TKN		TP		Primary Source	Secondary Source	Comments
	Inflow	Outflow	Inflow	Outflow	Inflow	Outflow	Inflow	Outflow	Inflow	Outflow	Inflow	Outflow			
Shallow Marsh	11.85 ppm	7.85 ppm	1.14 ppm	0.99 ppm			0.2 ppm	0.15 ppm			0.085ppm	0.045ppm	Blackburn, R., P.L. Pimentel and G.E. French. 1986. Treatment of Stormwater Runoff Using Aquatic Plants. The Use of Wetlands for Controlling Stormwater Pollution. Strecker, E.W. J.M. Kersnar and E.E. Driscoll (Eds.). Woodward-Clyde Consultants. Portland, Oregon. Prepared for the USEPA, Region V, Water Division, Watershed Management Unit. EPA/600/3-86/001.	Winer, R. 2000. National Pollutant Removal Performance Database for Stormwater Treatment Practices, 2 <sup>nd</sup> Edition. Center for Watershed Protection. Ellicott City, MD.	Land use = Golf Course; Size of Wetland = 296acres; # of storms = 72; Treatment volume = 1in; Drainage area = 2340acres
Shallow Marsh	7.55	1.801	0.756	1.206			0.085	0.016			0.98	0.04	Can, D. and B. Rushton. 1995. Integrating a Herbaceous Wetland into Stormwater Management. Stormwater Research Program. Southwest Florida Water Management District. Brooksville, FL.	Winer, R. 2000. National Pollutant Removal Performance Database for Stormwater Treatment Practices, 2 <sup>nd</sup> Edition. Center for Watershed Protection. Ellicott City, MD.	# of storms = 81; Drainage area = 15.3; STP size = 3acres
Shallow Marsh	14	12									0.097	0.071	Koon, J. 1995. Evaluation of Water Quality Ponds and Swales in the Issaquah/East Lake Sammamish Basins. King County Surface Water Management and Washington Department of Ecology. Seattle, WA.	Winer, R. 2000. National Pollutant Removal Performance Database for Stormwater Treatment Practices, 2 <sup>nd</sup> Edition. Center for Watershed Protection. Ellicott City, MD.	Two cell wetland, first cell 2ft deep pool with emergent wetlands; second cell is free." # of storms = 5; Design Basis = 2 & 25 year quantity control only; Drainage area = 7.7acres; "Inflow and Outflow values are presented as mean concentrations."

6.6.2 WET POND / RETENTION BASIN

\*\*UNITS ARE MG/L UNLESS OTHERWISE NOTED\*\*

Type	TSS		TN		NO <sub>3</sub>		NO <sub>x</sub>		TKN		TP		Primary Source	Secondary Source	Comments
	Inflow	Outflow	Inflow	Outflow	Inflow	Outflow	Inflow	Outflow	Inflow	Outflow	Inflow	Outflow			
Wet Extended Detention Pond	177	39	3.352	1.459							0.761	0.214	Borden, R.C., J.L. Dorn, J.B. Stillman and S.K. Liehr. 1996. Draft Report. Evaluation of Ponds and Wetlands For Protection of Public Water Supplies. Water Resources Research Institute of the University of North Carolina. Department of Civil Engineering. North Carolina State University.	Winer, R. 2000. National Pollutant Removal Performance Database for Stormwater Treatment Practices, 2 <sup>nd</sup> Edition. Center for Watershed Protection. Ellicott City, MD.	Land Use = Dairy Farms, woodland; Impervious Cover = 16
Wet Extended Detention Pond	71	12	1.713	0.769			0.416	0.062			0.232	0.112	Lower Colorado River Authority. 1997. Innovative NPS Pollution Control Program for Lake Travis in Central Texas. LCRA.	Winer, R. 2000. National Pollutant Removal Performance Database for Stormwater Treatment Practices, 2 <sup>nd</sup> Edition. Center for Watershed Protection. Ellicott City, MD.	Land Use = parking lot/commercial
Wet Extended Detention Pond	45	14	1.27	0.91			0.096	0.032			0.651	0.164	Rushton, B., C. Miller and H. Hull. 1995. The Effect of Residence Time on the Efficiency of a Wet Detention Stormwater Treatment Pond. Presented at the 31st Annual Conference and Symposium in Urban Areas. November 10-12, 1995.	Winer, R. 2000. National Pollutant Removal Performance Database for Stormwater Treatment Practices, 2 <sup>nd</sup> Edition. Center for Watershed Protection. Ellicott City, MD.	Impervious Cover = 30%; Residence time = 5 days
Wet Extended Detention Pond	28	11	1.35	1.16			0.24	0.09			0.4	0.176	Rushton, B., C. Miller and H. Hull. 1995. The Effect of Residence Time on the Efficiency of a Wet Detention Stormwater Treatment Pond. Presented at the 31st Annual Conference and Symposium in Urban Areas. November 10-12, 1995.	Winer, R. 2000. National Pollutant Removal Performance Database for Stormwater Treatment Practices, 2 <sup>nd</sup> Edition. Center for Watershed Protection. Ellicott City, MD.	Impervious Cover = 30%; Residence Time = 2 days
Wet Extended Detention Pond	131	7	1.61	0.722			0.396	0.062			0.497	0.053	Rushton, B., C. Miller and H. Hull. 1995. The Effect of Residence Time on the Efficiency of a Wet Detention Stormwater Treatment Pond. Presented at the 31st Annual Conference and Symposium in Urban Areas. November 10-12, 1995.	Winer, R. 2000. National Pollutant Removal Performance Database for Stormwater Treatment Practices, 2 <sup>nd</sup> Edition. Center for Watershed Protection. Ellicott City, MD.	Impervious Cover = 30%; Land Use = rooftops, parking lots, vehicle storage; Residence Time = 14days
Wet Pond	20.6	6.5	0.93	0.65			0.18	0.02			0.136	0.035	Cullum, M. 1984. Volume II Evaluation of the Water Management System at a Single Family Residential Site: Water Quality Analysis for Selected Storm Events at Timbercreek Subdivision in Boca Raton, FL. South Florida Water Management	Winer, R. 2000. National Pollutant Removal Performance Database for Stormwater Treatment Practices, 2 <sup>nd</sup> Edition. Center for Watershed Protection. Ellicott City, MD.	Land Use = single family residential; Soil type = group A; Treatment Vol = 3.11in/acre

6.6.2 WET POND / RETENTION BASIN (cont.)

\*\*UNITS ARE MG/L UNLESS OTHERWISE NOTED\*\*

Type	TSS		TN		NO <sub>3</sub>		NO <sub>x</sub>		TKN		TP		Primary Source	Secondary Source	Comments
	Inflow	Outflow	Inflow	Outflow	Inflow	Outflow	Inflow	Outflow	Inflow	Outflow	Inflow	Outflow			
Wet Pond	7	15							1.2	1.27	0.272	0.155	Dorman, M.E., J. Hartigan, R.F. Steg, and T. Quasebarth. 1989. Retention, Detention and Overland Flow for Pollutant Removal from Highway Stormwater Runoff. Vol. 1. Research Report. Federal Highway Administration.	Winer, R. 2000. National Pollutant Removal Performance Database for Stormwater Treatment Practices, 2 <sup>nd</sup> Edition. Center for Watershed Protection. Ellicott City, MD.	Land Use = Highway
Wet Pond	52	23	2.62	1.92			0.729	0.224	1.89	1.7	0.3	0.4	Dorman, M.E., J. Hartigan, R.F. Steg, and T. Quasebarth. 1989. Retention, Detention and Overland Flow for Pollutant Removal from Highway Stormwater Runoff. Vol. 1. Research Report. Federal Highway Administration.	Winer, R. 2000. National Pollutant Removal Performance Database for Stormwater Treatment Practices, 2 <sup>nd</sup> Edition. Center for Watershed Protection. Ellicott City, MD.	Land Use = Highway
Wet Pond	45	19	1.64	1.39					0.31	0.31	0.17	0.12	Gain, S.W. The effects of Flow-Path Modifications on Urban Water-Quality Constituent Retention in Urban Stormwater Detention Pond and Wetland System, Orlando, Florida. Florida Department of Transportation, Orlando, FL.	Winer, R. 2000. National Pollutant Removal Performance Database for Stormwater Treatment Practices, 2 <sup>nd</sup> Edition. Center for Watershed Protection. Ellicott City, MD.	Inflow and Outflow are reported as a mean concentration. "Pond was modified to increase detention time and was previously studied by Martin and Smoot (1988)." Percent efficiency calculated using event mean concentration (EMC)
Wet Pond									0.79	0.63	0.12	0.08	Wu, J. 1989. Evaluation of Detention Basin Performance in the Piedmont region of North Carolina. North Carolina Water Resources Research Institute. Report No. 89-248. Raleigh, NC.	Winer, R. 2000. National Pollutant Removal Performance Database for Stormwater Treatment Practices, 2 <sup>nd</sup> Edition. Center for Watershed Protection. Ellicott City, MD.	Land use = residential; housing, woodland; Impervious cover = 38%; Soil type = clay; Surface area = 3.3 acres, Mean pond depth = 3.8'; Volume=12.3acre feet; "No geese present." Percent efficiency calculated using event mean concentration (EMC)
Wet Pond									0.86	0.59	0.14	0.08	Wu, J. 1989. Evaluation of Detention Basin Performance in the Piedmont region of North Carolina. North Carolina Water Resources Research Institute. Report No. 89-248. Raleigh, NC.	Winer, R. 2000. National Pollutant Removal Performance Database for Stormwater Treatment Practices, 2 <sup>nd</sup> Edition. Center for Watershed Protection. Ellicott City, MD.	Land use = residential; Impervious cover = 46%; Residential = 100%; Pond = 4.9 acres; Mean pond depth = 8'; Volume = 38.8 acre feet; "Geese population present increase N and P values." Percent efficiency calculated using event mean concentration (EMC)





-

---

# **Pennsylvania Stormwater Best Management Practices Manual**

---

## **Appendix B – Pennsylvania Native Plant List**





## Appendix B – Pennsylvania Native Plant List

The BMP Plant List contains information about plant species native to Pennsylvania that are suitable for use in any number of BMPs. The list is sorted by plant type and then by scientific name. The table also contains information helpful for designing a planting plan for a successful BMP.

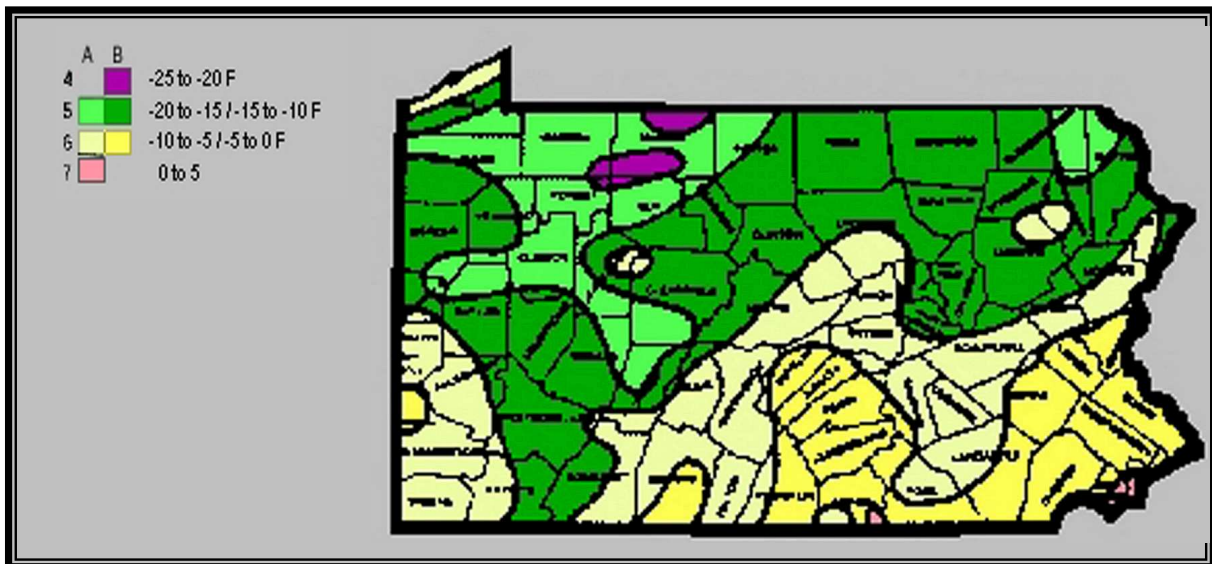
### Plant Type

Herbaceous plants are broken down into the following categories; ferns, grasses, grass-like plants, and forbs. Woody plants are broken down into the following categories; shrubs, trees, and trees (small). Small trees are under story and ornamental trees. These trees are useful when a canopy tree is impractical or an aesthetic impact needs to be made.

### Hardiness Zone

Ideal hardiness zone ranges are given for the plants. These zone numbers correspond to the “USDA Plant Hardiness Zone Map”. Pennsylvania is mainly in zones five (5) and six (6). There is a small area of zone four (4) located in the northwestern part of the state and a small area of zone seven (7) located in the southeast.

The map is available on line through the USDA.  
<http://www.usna.usda.gov/Hardzone/index.html>



### Commercial Availability

Care was taken to develop a list of plants that would be both successful and obtainable. It is still important to plan ahead and locate plant materials in advance of planting. Plant materials should be located at least six (6) months in advance of planting. This gives enough time to locate approved substitutions in the case that some species are unavailable

### Wildlife Value

Attracting beneficial wildlife increases the function and value of a BMP. Wildlife pollinates plants, distributes seed, and enhances the ecological value of the wetland. Note that some wildlife, such as

Canada goose and muskrat can be problematic and will destroy new plantings unless exclusion fencing is provided.

### **Wetland Indicator Status**

The wetland indicator status is from the National List of Plant Species that Occur in Wetlands: Northeast (Region 1) compiled by the U.S. Fish and Wildlife Service. This list indicates the likelihood that a plant will be found in a wetland. A “+” after the indicator symbol shows that the species is more often found in wetlands than other species with the same indicator symbol. Conversely, a “-“ after the indicator symbol shows that the species is less often found in wetlands than other species with the same indicator symbol.

Since wetland indicator status is generalized and does not represent information about depth or frequency of inundation, the “Inundation Tolerance” “Hydrologic Zone” and fields are also included in this plant list to assist the designer in selecting the appropriate plant species.

### **Inundation Tolerance**

Inundation Tolerance gives information about frequency and depth of inundation that plant species can tolerate during the growing season. A “no” indicates plants that do not survive saturated soils or standing water during the growing season. These are typically upland plants. “Saturated” indicates plants that survive inundation and saturated soils, typically during greater than 50% of the growing season. “Seasonal” indicates that the plant is able to withstand occasional inundation and saturated soils, typically during less than 50% of the growing season. Available information on water depths tolerated by aquatic plants are provided where available. It is difficult to give the exact hydrologic requirements of plants in a general list such as this. As such, we suggest that further research be performed to confirm the requirements of particular species.

### **Hydrologic Zone**

#### **Zone 1: Open Water: Permanent Pool (12 inches to 6 feet)**

Open water and permanent pools range from 12 inches to 6 feet in depth and are best colonized by submergent plants, if at all. This deep-water zone is not routinely planted for several reasons. There are a limited number of plant species that typically survive and grow in this zone, and many are not commercially available; open water areas, free of vegetation, provide unique habitat; and, deep water aquatic plants can clog the stormwater facility outlet structure. In many cases, plants such as duckweed (*Lemna minor*), a floating plant, will naturally colonize open water via transport of plant fragments from upstream or on wildlife. If submerged plant material becomes more commercially available and clogging concerns are addressed, this area can be planted. If the designer chooses to vegetate a deep-water area, then the function of vegetated deep water areas is to absorb nutrients in the water column, enhance sediment deposition, improve oxidation and create additional aquatic habitat.

Select plants that can:

- Withstand constant inundation of water of 1 foot or greater in depth;
- Withstand being submerged partially or entirely;
- Enhance pollutant uptake; and
- Provide food and cover for waterfowl, fish, amphibians, desirable insects, and other aquatic life.

Suggested emergent or submergent species include, but are not limited to: water lily (*Nymphaea odorata*), wild celery (*Vallisneria spiralis*), sago pondweed (*Potamogeton pectinatus*), and redhead grass (*Potamogeton perfoliatus*).

### **Zone 2: Shallow Water Terrace / Aquatic Bench (6 inches to 12 inches)**

Zone 2 includes all areas that are inundated by the normal pool to a depth of 1 foot. Zone 2 coincides with the aquatic bench or shelf found in many BMP's. This zone offers ideal conditions for the growth of wide variety of emergent wetland species. These areas will typically fringe the pond or can be developed on shallow water shelves constructed within the pond. When planted, Zone 2 provides important habitat for many aquatic animals, which will naturally regulate mosquito populations, eliminating the need for insecticide applications. In order to create a natural setting, emergent plants are typically planted in groups or clusters of like species. As this zone matures, some species will dominate portions of the site and some species may be eliminated. Local conditions will determine which species adapt most readily. Some species will migrate upslope into saturated soils and others will spread to colonize slightly deeper water.

Select plants that can:

- Withstand constant inundation of water to depths between six inches and 1 foot deep;
- Be partially submerged;
- Enhance pollutant uptake and transformation; and
- Provide food and cover for waterfowl, desirable insects, and other aquatic life.

Emergent herbaceous plants will stabilize the bottom and edge of the pond, slow water velocities, absorb wave energy, and reduce erosion when the water level fluctuates. Plants can also soften the engineered contours of the pond and conceal drawdowns during dry weather.

Appropriate herbaceous species include: water plantain (*Alisma plantago-aquatica*), common three square (*Scirpus pungens*), managrasses (*Glyceria* spp.), blue flag iris (*Iris versicolor*), soft rush (*Juncus effusus*), arrow arum (*Peltandra virginica*), smartweeds (*Polygonum* spp.), pickerelweed (*Pontederia cordata*), duck potato (*Sagittaria latifolia*), lizard tail (*Saururus cernuus*), soft stem bulrush (*Scirpus tabernaemontanii*), giant bur-reed (*Sparganium eurycarpum*) and American bur-reed (*Sparganium americanum*). There are few trees or shrubs, such as buttonbush (*Cephalanthus occidentalis*) and black willow (*Salix nigra*), that will become established or survive within Zone 2.

### **Zone 3: BMP Fringe: Low Marsh (0-6 inches regular inundation)**

Zone 3 encompasses the waterward shoreline of a pond or wetland and its width will be determined by the design slope. This zone will be permanently inundated by the design elevation of any control structures. However, this zone is likely to become dryer during periods of drought. This zone provides the interface between the permanently inundated zone and the seasonally saturated. This zone can be planted with FACW- or FAC plants as identified in the attached BMP Plant List, as plants must be able to withstand periods of inundation as well as drought during the growing season. Zone 3 should be heavily planted to ensure vigorous cover to protect the shoreline. This zone provides opportunities for a number of herbaceous plants, shrubs and trees.

Select plants that can:

- Stabilize the shoreline to minimize erosion caused by wave and wind action or water fluctuation;
- Withstand regular inundation of water, as plants will be partially submerged at times;

- Provide shade along the southern exposure to help reduce temperature of open waters;
- enhance pollutant uptake;
- Provide food and cover for waterfowl, songbirds, and wildlife (large plants can be selected and located to control overpopulation of waterfowl);
- Be located to reduce human access to potential hazards without blocking maintenance access;
- Have little or no maintenance requirements because they may be difficult or impossible to reach; and,

Herbaceous species that do well in Zone 3 include: blue flag iris (*Iris versicolor*), sweet flag (*Acorus calamus*), swamp milkweed (*Asclepias incarnata*), reedtop (*Agrostis* spp.), switchgrass (*Panicum virgatum*), Canada bluejoint (*Calamagrostis canadensis*), many bulrushes (*Scirpus* spp.), and spike rushes (*Eleocharis* spp.). If shading is needed along the shoreline, the following woody species are suggested: smooth or speckled alder (*Alnus* spp.), pussy willow (*Salix discolor*), swamp rose (*Rosa palustris*), buttonbush (*Cephalanthus occidentalis*), highbush blueberry (*Vaccinium corymbosum*), red osier/silky dogwood (*Cornus stolonifera/amomum*), gray dogwood (*Cornus racemosa*), arrowwood (*Viburnum dentatum*), spicebush (*Lindera Benzoin*), sweet pepperbush (*Clethra alnifolia*), winterberry (*Ilex verticillata*), inkberry holly (*Ilex glabra*), serviceberry (*Amelanchier* spp.), river birch (*Betula nigra*), red maple (*Acer rubrum*), silver maple (*Acer saccharinum*), green ash (*Fraxinus pennsylvanica*), sweetgum (*Liquidambar styraciflua*), sweet bay magnolia (*Magnolia virginiana*), black gum (*Nyssa sylvatica*), American sycamore (*Platanus occidentalis*) willow oak (*Quercus phellos*), swamp white oak (*Quercus bicolor*), pin oak (*Quercus palustris*) and black willow (*Salix nigra*).

**Zone 4: BMP Fringe: High Marsh (periodic inundation, saturated soils)**

Zone 4 extends upslope from Zone 3 and encompasses the area that may be subject to periodic inundation after storms. The width of this zone will depend on the design slope. This zone will include the majority of the temporary extended detention area. The soil substrate will be periodically saturated.

Select plants that can:

- Withstand periodic inundation of water after storms, as well as significant drought during the warm summer months;
- Stabilize the ground from erosion caused by run-off;
- Provide shade along the southern exposure to help reduce temperature of open waters;
- Enhance pollutant uptake;
- Be very low maintenance, as they may be difficult or impossible to access;
- provide food and cover for waterfowl, songbirds, and wildlife (plants may also be selected and located to control overpopulation of waterfowl); and
- be located to create a natural barrier to the deeper pools.
- many species available for planting in this zone also include aesthetic qualities.

Native plants are preferred because they are low-maintenance and disease-resistant.

Frequently used plant species in Zone 4 include: asters (*Aster* spp.) and goldenrods (*Solidago* spp.), beebalm (*Monarda didyma*), bergamot (*Monarda fistulosa*), ironweed (*Vernonia noveboracensis*), blue vervain (*Verbena hastata*), spotted and purple Joe-pye weed (*Eupatorium* spp.), swamp milkweed (*Asclepias incarnata*), switchgrass (*Panicum virgatum*), shrub dogwoods (*Cornus* spp.), swamp rose (*Rosa palustris*), inkberry (*Ilex glabra*), arrowwood (*Viburnum dentatum*), sweet pepperbush (*Clethra alnifolia*), bayberry (*Myrica pennsylvanica*), elderberry (*Sambucus canadensis*), serviceberry (*Amelanchier arborea*), sweetbay magnolia (*Magnolia virginiana*), green ash (*Fraxinus pennsylvanica*), river birch (*Betula nigra*), sweetgum (*Liquidambar styraciflua*), Ironwood (*Carpinus caroliniana*), eastern red cedar (*Juniperus virginiana*), and red maple (*Acer rubrum*).

### **Zone 5: Floodplain Terrace (infrequent inundation, temporarily saturated soils)**

Zone 5 is infrequently inundated by floodwaters that quickly recede in a day or less. Key landscaping objectives for Zone 5 are to stabilize the slopes characteristic of this zone and establish low maintenance natural vegetation.

Select plants that can:

- Withstand infrequent but brief inundation during storms and, between storms, typical moisture conditions that may be moist, slightly wet, or even swinging entirely to drought conditions during the dry weather period;
- Stabilize the basin slopes from erosion;
- Be very low maintenance as ground cover since they may be difficult to access on steep slopes or mowing frequency may be limited (a dense tree cover may help reduce maintenance and discourage resident geese); and
- Provide food and cover for waterfowl, songbirds, and wildlife.

Some commonly planted species in Zone 5 include:

black eyed Susan (*Rudbeckia hirta*), purple coneflower (*Echinacea purpurea*), warm season grasses such as switchgrass (*Panicum virgatum*), Indian grass (*Sorghastrum nutans*), and little bluestem (*Schizachyrium scoparium*), many viburnums (*Viburnum* spp.), Virginia rose (*Rosa virginiana*), Ironwood (*Carpinus caroliniana*), cherries (*Prunus* spp.), red oak (*Quercus rubra*), scarlet oak (*Quercus coccinea*), willow oak (*Quercus phellos*), hickories (*Carya* spp.), eastern red cedar (*Juniperus virginiana*), hackberry (*Celtis occidentalis*) and witch-hazel (*Hamamelis virginiana*).

### **Zone 6: Upland (never inundated)**

This zone extends above the maximum design water surface elevation and often includes the outermost buffer of a pond or wetland. Plant selections should be made based on soil condition, light, and function within the landscape because little or no water inundation will occur. Ground covers should require infrequent mowing to reduce the cost of maintaining this landscape. Placement of plants in Zone 6 is important since they are often used to create a visual focal point, frame a desirable view, screen undesirable views, serve as a buffer, or provide shade to allow a greater variety of plant materials. Particular attention should be paid to seasonal color and texture of these plantings.

Some frequently used plant species in Zone 6 include:

Large growing trees such as basswood (*Tilia americana*), white oak (*Quercus alba*), scarlet oak (*Quercus coccinea*), Black oak (*Quercus velutina*), American beech (*Fagus grandifolia*), white ash (*Fraxinus americana*), Tulip poplar (*Liriodendron tulipifera*) and white pine (*Pinus strobus*); and small ornamental trees such as Flowering dogwood (*Cornus florida*) and redbud (*Cercis canadensis*). The herbaceous layer should be seeded or planted with a mix of warm season grasses and upland wildflowers.

### **Notes**

This column contains helpful details about the plant species.

BMP PLANT LIST

Common Name	Scientific Name	Plant Type	Wetland Indicator	Hydrologic Zone	Inundation Tolerance	Hardiness Zone	Commercial Availability	Wildlife Value	Notes
Fern, hay-scented	<i>Dennstaedtia punctilobula</i>	Fern	NI	4,5,6	No	4-8	Plants	Tolerate Deer Browsing.	Shade to partial sun.
Fern, marginal shield	<i>Dryopteris marginalis</i>	Fern	FACU-	4,5,6	No	5-8	Plants		Partial sun. Shade tolerant. Evergreen.
Fern, sensitive	<i>Onoclea sensibilis</i>	Fern	FACW	[3,4],5	Saturated	4-9	Plants	Moderate. Songbirds and small mammals	Full to partial sun. Shade tolerant
Fern, cinnamon	<i>Osmunda cinnamomea</i>	Fern	FACW	2,[3,4]	Saturated	4-8	Plants	Moderate. Songbirds and small mammals	Full to partial sun. Shade tolerant. Young "fiddle heads"
Fern, royal	<i>Osmunda regalis</i>	Fern	OBL	2,[3,4]	Saturated	4-9	Plants	Moderate. Small mammals.	Full to partial sun. Shade
Fern, New York	<i>Thelypteris noveboracensis</i>	Fern	FAC	[3,4],5	Saturated	2-8	Plants	Moderate. Songbirds and small mammals.	Partial sun. Shade tolerant. Drought tolerant.
Sweetflag	<i>Acorus americanus</i>	Forb	OBL	3,4	Seasonal		Plants, Rhizome	Low food. Good cover.	Tolerant of dry periods. Not a rapid colonizer. Tolerates acidic conditions.
Plantain, water	<i>Alisma plantago-aquatica (subcordatum)</i>	Forb	OBL			3-7			
Columbine, wild	<i>Aquilegia canadensis</i>	Forb	FAC	[4,5],6	No	3-8	Plants, Seed	Moderate. Butterflies, hummingbirds, and beneficial insects.	Full sun to full shade. Spreads by seed. Early spring flowers.
Milkweed, swamp	<i>Asclepias incarnata</i>	Forb	OBL	2,[3,4]	Saturated, 0-6"	3-8	Plants, Seed	Moderate. Butterflies, small mammals, and beneficial insects.	Full to partial sun. Drought tolerant. Not eaten by wildlife. Attractive flowers.
Milkweed, common	<i>Asclepias syriaca</i>	Forb	NI	5,6	No	4-9	Plants, Seed	High. Food for butterflies (esp. Monarch) and beneficial insects.	Full sun. Drought tolerant.
Butterflyweed	<i>Asclepias tuberosa</i>	Forb	NI	5,6	No	4-10	Plants, Seed	Moderate. Butterflies and beneficial insects.	Full to partial sun. Attractive orange flower.
Aster, white wood	<i>Aster divaricatus</i>	Forb	NI	4,[5,6]	No	4-8	Plants	Low. Butterflies and beneficial insects.	Very shade tolerant. Long lasting white flowers.
Aster, New England	<i>Aster novae-angliae</i>	Forb	FACW	[3,4],5	Seasonal	3-9	Plants, Seed	Cover for birds and mammals.	Attractive purple flowers. Tolerates dry soils.
Aster, New York	<i>Aster novibelgii</i>	Forb	FACW+	[3,4],5	Seasonal		Plants, Seed	Low. Butterflies and beneficial insects.	Pale purple flowers. Tolerates dry soils.
Trumpetweed	<i>Eupatorium fistulosum</i>	Forb	FACW	[3,4],5	Seasonal		Plants, Seed	Moderate. Butterflies, songbirds, and beneficial insects.	Full to partial sun. Tall plant with pink-purple flowers.
Joe-pye-weed, spotted	<i>Eupatorium maculatum</i>	Forb	FACW	[3,4],5	Seasonal		Plants, Seed	Moderate. Butterflies, songbirds, and beneficial insects.	Full to partial sun. Tall plant with pale purple flowers.
Boneset	<i>Eupatorium perfoliatum</i>	Forb	FACW+	[2,3],4	Seasonal		Plants, Seed	Moderate. Butterflies, songbirds, and beneficial insects.	Full to partial sun. Shade tolerant. Long lasting white
Joe-pye-weed, purple	<i>Eupatorium purpureum</i>	Forb	FAC	3,[4,5]	Seasonal		Plants, Seed	Moderate. Butterflies, songbirds, and beneficial insects.	Full to partial sun. Tall with showy flower.
Hibiscus, marsh	<i>Hibiscus moscheutos</i>	Forb	OBL	2,3	0-12"	5-11	Plants	Low. Hummingbirds.	Full to partial sun. Persistent during winter. Drought tolerant. Very showy pink to white flowers.
Iris, blue flag	<i>Iris versicolor</i>	Forb	OBL	2,[3,4]	0-6"	2-7	Plants, Seed	Moderate. Food muskrat and wildfowl. Cover, marshbirds. Persists under heavy grazing.	Slow growth. Full sun to partial shade. Tolerates clay. Fresh to moderately brackish water. Attractive blue flower.
Cardinal flower	<i>Lobelia cardinalis</i>	Forb	FACW+	3,4	Saturated	2-8	Plants, Seed	High. Nectar for hummingbird, oriole, butterflies.	Tolerates Partial shade. Does not persist well. Blood red flower.
Blue lobelia	<i>Lobelia siphilitica</i>	Forb	FACW+	3,4	Saturated		Plants, Seed	Moderate. Butterflies, hummingbirds, songbirds, and beneficial insects.	Full to partial sun. Shade tolerant. Attractive blue flower.
Monkey-flower	<i>Mimulus ringens</i>	Forb	OBL	3,4	Saturated	4-10	Plants, Seed	Low.	Full to partial sun. Interesting flower.



Common Name	Scientific Name	Plant Type	Wetland Indicator	Hydrologic Zone	Inundation Tolerance	Hardiness Zone	Commercial Availability	Wildlife Value	Notes
Fern, hay-scented	<i>Dennstaedtia punctilobula</i>	Fern	NI	4,5,6	No	4-8	Plants	Tolerate Deer Browsing.	Shade to partial sun.
Fern, marginal shield	<i>Dryopteris marginalis</i>	Fern	FACU-	4,5,6	No	5-8	Plants		Partial sun. Shade tolerant. Evergreen.
Fern, sensitive	<i>Onoclea sensibilis</i>	Fern	FACW	[3,4],5	Saturated	4-9	Plants	Moderate. Songbirds and small mammals	Full to partial sun. Shade tolerant
Fern, cinnamon	<i>Osmunda cinnamomea</i>	Fern	FACW	2,[3,4]	Saturated	4-8	Plants	Moderate. Songbirds and small mammals	Full to partial sun. Shade tolerant. Young "fiddle heads" edible.
Fern, royal	<i>Osmunda regalis</i>	Fern	OBL	2,[3,4]	Saturated	4-9	Plants	Moderate. Small mammals.	Full to partial sun. Shade tolerant.
Fern, New York	<i>Thelypteris noveboracensis</i>	Fern	FAC	[3,4],5	Saturated	2-8	Plants	Moderate. Songbirds and small mammals.	Partial sun. Shade tolerant. Drought tolerant.
Sweetflag	<i>Acorus americanus</i>	Forb	OBL	3,4	Seasonal		Plants, Rhizomes	Low food. Good cover.	Tolerant of dry periods. Not a rapid colonizer. Tolerates acidic conditions.
Plantain, water	<i>Alisma plantago-aquatica (subcordatum)</i>	Forb	OBL			3-7			
Columbine, wild	<i>Aquilegia canadensis</i>	Forb	FAC	[4,5],6	No	3-8	Plants, Seed	Moderate. Butterflies, hummingbirds, and beneficial insects.	Full sun to full shade. Spreads by seed. Early spring flowers.
Milkweed, swamp	<i>Asclepias incarnata</i>	Forb	OBL	2,[3,4]	Saturated, 0-6"	3-8	Plants, Seed	Moderate. Butterflies, small mammals, and beneficial insects.	Full to partial sun. Drought tolerant. Not eaten by wildlife. Attractive flowers.
Milkweed, common	<i>Asclepias syriaca</i>	Forb	NI	5,6	No	4-9	Plants, Seed	High. Food for butterflies (esp. Monarch) and beneficial insects.	Full sun. Drought tolerant.
Butterflyweed	<i>Asclepias tuberosa</i>	Forb	NI	5,6	No	4-10	Plants, Seed	Moderate. Butterflies and beneficial insects.	Full to partial sun. Attractive orange flower.
Aster, white wood	<i>Aster divaricatus</i>	Forb	NI	4,[5,6]	No	4-8	Plants	Low. Butterflies and beneficial insects.	Very shade tolerant. Long lasting white flowers.
Aster, New England	<i>Aster novae-angliae</i>	Forb	FACW	[3,4],5	Seasonal	3-9	Plants, Seed	Cover for birds and mammals.	Attractive purple flowers. Tolerates dry soils.
Aster, New York	<i>Aster novibelgii</i>	Forb	FACW+	[3,4],5	Seasonal		Plants, Seed	Low. Butterflies and beneficial insects.	Pale purple flowers. Tolerates dry soils.
Trumpetweed	<i>Eupatorium fistulosum</i>	Forb	FACW	[3,4],5	Seasonal		Plants, Seed	Moderate. Butterflies, songbirds, and beneficial insects.	Full to partial sun. Tall plant with pink-purple flowers.
Joe-pye-weed, spotted	<i>Eupatorium maculatum</i>	Forb	FACW	[3,4],5	Seasonal		Plants, Seed	Moderate. Butterflies, songbirds, and beneficial insects.	Full to partial sun. Tall plant with pale purple flowers.
Boneset	<i>Eupatorium perfoliatum</i>	Forb	FACW+	[2,3],4	Seasonal		Plants, Seed	Moderate. Butterflies, songbirds, and beneficial insects.	Full to partial sun. Shade tolerant. Long lasting white flower.
Joe-pye-weed, purple	<i>Eupatorium purpureum</i>	Forb	FAC	3,[4,5]	Seasonal		Plants, Seed	Moderate. Butterflies, songbirds, and beneficial insects.	Full to partial sun. Tall with showy flower.
Hibiscus, marsh	<i>Hibiscus moscheutos</i>	Forb	OBL	2,3	0-12"	5-11	Plants	Low. Hummingbirds.	Full to partial sun. Persistent during winter. Drought tolerant. Very showy pink to white flowers. Slow growth. Full sun to partial shade. Tolerates clay. Fresh to moderately brackish water.
Iris, blue flag	<i>Iris versicolor</i>	Forb	OBL	2,[3,4]	0-6"	2-7	Plants, Seed	Moderate. Food muskrat and wildfowl. Cover, marshbirds. Persists under heavy grazing.	Attractive blue flower
Cardinal flower	<i>Lobelia cardinalis</i>	Forb	FACW+	3,4	Saturated	2-8	Plants, Seed	High. Nectar for hummingbird, oriole, butterflies.	Tolerates Partial shade. Does not persist well. Blood red flower.

Common Name	Scientific Name	Plant Type	Wetland Indicator	Hydrologic Zone	Inundation Tolerance	Hardiness Zone	Commercial Availability	Wildlife Value	Notes
Reedgrass, bluejoint	<i>Calamagrostis canadensis</i>	Grass	FACW+	2,[3,4]	0-6", saturated		Seed, Plants		
Managrass, fowl	<i>Glyceria striata</i>	Grass	OBL	[2,3],4	Seasonal		Plants, Seed		
Fowl mannagrass	<i>Glyceria striata</i>	Grass	OBL	[2,3],4	Seasonal		Plants, Seed	High. Food for waterfowl, muskrat, and deer.	Partial to full shade.
Cutgrass, rice	<i>Leersia oryzoides</i>	Grass	OBL	[2,3],4	0-6"		Plants, Seed	High. Food and cover.	Full sun although tolerant of shade. Shoreline stabilization.
Switchgrass	<i>Panicum virgatum</i>	Grass	FAC	[4,5],6	Seasonal	4-9	Seed and Plants	High. Seeds, cover for waterfowl, songbirds.	Tolerates wet/dry conditions.
Indiangrass	<i>Sorghastrum nutans</i>	Grass	UPL	5,6	No	3-9	Seed, Plants	High. Good food and cover.	Full sun. Grows 4-6 feet tall.
Bluestem, little	<i>Schizachyrium scoparium</i>	Grass	FACU-	6	No	3-9	Seed, Plants		Full sun. Tolerates poor soils and drought.
Sedge, fringed	<i>Carex crinita</i>	Grass-like	OBL	2,[3,4]	Saturated		Plants, Seed	Moderate. Songbirds and waterfowl. Good food and cover.	Full to partial sun.
Sedge, Pennsylvania	<i>Carex pennsylvanica</i>	Grass-like	NI	5,6	Yes	4-8	Plants, Seed	Moderate. Songbirds and waterfowl.	Partial sun. Shade tolerant.
Sedge, broom	<i>Carex scoparia</i>	Grass-like	FACW	3,[4],5	Sat, 0-6"		Plants, Seed	Moderate. Good food and wildlife cover.	Tolerates moist to dry conditions.
Sedge, tussock	<i>Carex stricta</i>	Grass-like	OBL	1,[2,3],4	Sat. 0-6"	5-9	Plants, Seed	Moderate. Songbirds.	Full sun. Persists during winter.
Sedge, fox	<i>Carex vulpinoidea</i>	Grass-like	OBL	1,2,[3],4	Sat. 0-6"		Plants, Seed	High. Songbirds and waterfowl.	Full to partial sun. Prefers fluctuating water levels.
Rush, Canada	<i>Juncus canadensis</i>	Grass-like	OBL	2,[3,4]	Sat. 0-6"		Plants, Seed	Moderate. Songbirds, waterfowl, and small mammals	Full to partial sun. Shown to have good nutrient uptake
Rush, soft	<i>Juncus effusus</i>	Grass-like	FACW+	[2,3],4	0-1'	3-8	Plants, Seed	Moderate	Tolerates occasional dry conditions. Full to partial sun. Shown to have good nutrient uptake properties
Bulrush, hard-stem	<i>Scirpus acutus</i>	Grass-like	OBL	[1,2],3	0-3'		Plants, Seed	High. Cover, food (achenes, rhizomes) ducks, geese, muskrat, fish. Nesting for bluegill and bass.	Quick to establish, fresh to brackish. Good for sediment stabilization and erosion control. Shown to have good nutrient uptake
Woolgrass	<i>Scirpus cyperinus</i>	Grass-like	FACW	2,[3,4]	Saturated	4-8	Plants, Seed	Moderate. Cover, food.	Requires full sun. Can tolerate acidic soils, drought. Colonizes disturbed areas, moderate growth. Shown to have good nutrient uptake
Bulrush, three-square	<i>Scirpus pungens</i>	Grass-like	FACW+	[2,3],4	Saturated, 0-6"		Plants, Seed	High. Seeds, cover. Waterfowl and fish.	Shown to have good nutrient uptake. High metal removal. Drought tolerant.
Bulrush, softstem	<i>Scirpus tabermontanii</i>	Grass-like	OBL	1,[2,3]	0-1'		Plants, Seed	High. Good cover and food.	Full sun. Aggressive colonizer. High pollutant removal.
Bur-reed, American	<i>Sparganium americanum</i>	Grass-like	OBL	[2,3],4	Saturated, 0-6"		Plants, Seed	Good food and cover.	Spreads rapidly. Tolerates partial shade.
Bur-reed, giant	<i>Sparganium eurycarpum</i>	Grass-like	OBL	1,[2,3]	0-12"		Plants, Seed	High. Food (seeds, plant) waterfowl, beaver and other mammals. Cover for marshbirds, waterfowl.	Rapid spreading. Tolerates partial sun. Good for shoreline stabilization. Salinity <0.5 ppt.
Cattail, narrowleaf	<i>Typha angustifolia</i>	Grass-like	OBL	1,[2,3]	0-1'	3-11	Plants	Low food. Good nesting and cover.	Spreads rapidly, can be invasive. Shown to have good nutrient uptake properties.
Cattail, broadleaf	<i>Typha latifolia</i>	Grass-like	OBL	1,[2,3]	0-1'	3-9	Plants	Low food. Good nesting and cover.	Spreads rapidly, can be invasive. Shown to have good nutrient uptake properties.
Alder, speckled	<i>Alnus rugosa</i>	Shrub	FACW+	2,3	Saturated		Yes	High. Cover, browse for deer, seeds for birds.	Rapid growth. Stabilizes streambanks. Roots fix N2.
Alder, smooth	<i>Alnus serrulata</i>	Shrub	OBL	[1,2],3	Saturated, 0-3"		Yes	High. Food, cover.	Rapid growth. Stabilizes streambanks. Roots fix N2.

Common Name	Scientific Name	Plant Type	Wetland Indicator	Hydrologic Zone	Inundation Tolerance	Hardiness Zone	Commercial Availability	Wildlife Value	Notes
Choke Berry, Red	<i>Aronia arbutifolia</i>	Shrub	FACW	3,[4,5]	Seasonal	4-9	Yes	Moderate. Songbirds.	Bank stabilizer. Partial sun. White flowers with red fruit.
Choke Berry, Black	<i>Aronia melanocarpa</i>	Shrub	FAC	3,[4,5]	Seasonal		Yes	Moderate. Songbirds.	Partial sun. White flowers with black fruit.
Bottonbush, common	<i>Cephalanthus occidentalis</i>	Shrub	OBL	[1,2],3	0-3'	5-10	Yes	High. Ducks and shorebirds. Seeds, nectar and nesting.	Full sun to partial shade. Will grow in dry areas. Interesting flowers and seed.
Pepper-bush, sweet	<i>Clethra alnifolia</i>	Shrub	FAC+	[3,4],5	Seasonal	3-9	Yes	Moderate. Butterflies, songbirds, waterfowl, small mammals, and beneficial insects.	Partial sun. Shade tolerant. Attractive white flower spikes.
Dogwood, silky	<i>Cornus amomum</i>	Shrub	FACW	[3,4],5	Seasonal	5-8	Yes	High. Songbirds and mammals.	Shade and drought tolerant. Good bank stabilizer. White flowers with blue fruit. Stems have good winter color.
Dogwood, gray	<i>Cornus racemosa</i>	Shrub	FAC	3,[4,5]	Seasonal		Yes	High. Songbirds, waterfowl, and small mammals.	Full to partial sun. Shade tolerant. Drought tolerant. White flowers and fruit.
Dogwood, redbud	<i>Cornus sericea</i>	Shrub	FACW+	[3,4],5	Seasonal		Yes	High. Songbirds, waterfowl, and small mammals.	Full to partial sun. Shade tolerant. Drought tolerant. Good streambank stabilizer. White flowers and fruit.
Hazel-nut, American	<i>Corylus americana</i>	Shrub	FACU-	4,[5,6]	No	4-9	Yes	Moderate. Songbirds and small mammals	Partial sun to shade. Inhabits dry woodlands. Edible nuts. Wood used for divining rods.
Witch-hazel, American	<i>Hamamelis virginiana</i>	Shrub	FAC-	4,[5,6]	No	4-9	Yes	Low. Food for squirrels, deer, and ruffed grouse.	Prefers shade. Ornamental. Unusual flowers in Nov. - Dec.
Inkberry	<i>Ilex glabra</i>	Shrub	FACW-	3,[4,5]	Seasonal		Yes	High. Songbirds, waterfowl, and small mammals.	Full to partial sun. Shade tolerant. Evergreen. Avoided by
Winterberry, common	<i>Ilex verticillata</i>	Shrub	FACW+	[3,4],5	Seasonal	3-9	Yes	High. Cover and fruit for birds. Holds berries into winter.	Full sun to partial shade. Seasonally flooded areas. Red fruits persist through winter.
Spice Bush	<i>Lindera benzoin</i>	Shrub	FACW-	3,4,5	seasonal	5-9	Yes	Very high. Songbirds.	Shade and rich soils. Tolerates acidic soils. Good understory species. Red berries.
Bayberry, northern	<i>Myrica pennsylvanica</i>	Shrub	FAC	[3,4],5	Seasonal		Yes	High. Nesting, food, cover. Berries last into winter.	Coastal Plain species. Roots fix N2. Drought tolerant.
Azalea, swamp	<i>Rhododendron viscosum</i>	Shrub	OBL	[3,4],5	Saturated	3-9	Yes	Low. Waterfowl and small mammals.	Full to partial sun. Susceptible to damage from disease and insects. Showy pink and white flowers.
Sumac, smooth	<i>Rhus glabra</i>	Shrub	NI	4,[5,6]	No	3-8	Yes	High. Songbirds, small mammals, and beneficial insects.	Full sun. Drought resistant.
Rose, pasture	<i>Rosa carolina</i>	Shrub	NI	5,6	No	5-9	Yes	High. Songbirds, and small mammals.	Full to partial sun.
Rose, swamp	<i>Rosa palustris</i>	Shrub	OBL	2,[3,4]	Saturated	5-8	Yes	High. Food (hips) for birds including turkey, ruffed grouse and mammals. Fox cover.	Prefers full sun. Easy to establish. Low salt tolerance. Avoided by deer.
Rose, Virginia	<i>Rosa virginiana</i>	Shrub	FAC	3,[4,5]	Seasonal	3-8	Yes	High. Songbirds, and small mammals.	Full to partial sun.
Blackberry, common	<i>Rubus allegheniensis</i>	Shrub	FACU-	4,5,6	No		Yes	High Butterflies, songbirds, small mammals, and beneficial insects.	Full to partial sun. Edible fruit.
Willow, pussy	<i>Salix discolor</i>	Shrub	FACW	[3,4],5	Yes	4-8	Yes	Low. Buds eaten by grouse.	Furry catkins are a harbinger of spring. Good streambank stabilizer. Roots easily from cuttings.
Elderberry	<i>Sambucus canadensis</i>	Shrub	FACW-	3,4,5,6	Yes	3-9	Yes	Extremely high. Food and cover, birds and mammals.	Full sun to partial shade. Drought tolerant. Bears fruit when four years old.

Common Name	Scientific Name	Plant Type	Wetland Indicator	Hydrologic Zone	Inundation Tolerance	Hardiness Zone	Commercial Availability	Wildlife Value	Notes
Blueberry, highbush	<i>Vaccinium corymbosum</i>	Shrub	FACW-	[3,4],5,6	Seasonal	3-8	Yes	High. Butterflies, songbirds, waterfowl, and small mammals.	Full to partial sun. Shade tolerant. Prefers acid soils. Attractive plant year round.
Arrow-wood, southern	<i>Viburnum dentatum</i>	Shrub	FAC	3,[4,5],6	Seasonal	4-8	Yes	High. Songbirds and mammals.	Grows best in sun to partial shade. Drought tolerant.
Black-haw	<i>Viburnum prunifolia</i>	Shrub	FACU	4,5,6	No	3-9	Yes	High. Songbirds and small mammals.	Full to partial sun. Shade tolerant.
Box-elder	<i>Acer negundo</i>	Tree	FAC+	3,[4,5]	Seasonal	2-9	Yes	Moderate. Songbirds and small mammals.	Full to partial sun. Forms thickets. Wood can be brittle. Rapid growth. Tolerates acidic soil.
Maple, red	<i>Acer rubrum</i>	Tree	FAC	3,[4,5]	Seasonal	3-9	Yes	High. Seeds and browse.	
Maple, silver	<i>Acer saccharinum</i>	Tree	FACW	3,[4,5]	Seasonal	3-9	Yes	Moderate. Songbirds and small mammals. Excellent for cavity nesting wildlife.	Full to partial sun.
Birch, river	<i>Betula nigra</i>	Tree	FACW	[3,4],5	Seasonal	4-9	Yes	High. Songbirds.	Bank erosion control. Full sun. Nice ornamental.
Birch, gray	<i>Betula populifolia</i>	Tree	FAC	[4,5],6	Seasonal		Yes	Moderate. Songbirds.	Short lived tree (30-50 years). Early successional species. Partial sun. Shade tolerant.
Ironwood	<i>Carpinus caroliniana</i>	Tree	FAC	3,[4,5],6	Seasonal	3-9	Yes	Moderate. Songbirds, waterfowl, and small mammals.	Small understory tree. Smooth gray bark.
Hickory, sweet pignut	<i>Carya glabra</i>	Tree	FACU-	4,[5,6]	No	4-9	No	Moderate. Songbirds, waterfowl, and small mammals.	Full to partial sun. Hardy and slow growing.
Hickory, shag-bark	<i>Carya ovata</i>	Tree	FACU-	4,[5,6]	No	4-8	Yes	Moderate. Songbirds, waterfowl, and small mammals.	Full sun. Distinctive peeling bark.
Cedar, Atlantic white	<i>Chamaecyparis thyoides</i>	Tree	OBL	[1,2],3,4	Saturated	4-8	Yes		Partial sun. Shade tolerant. Edible nuts, prolific seed production. Usually found in areas with fluctuating water tables. Evergreen.
Beech, American	<i>Fagus grandifolia</i>	Tree	FACU	4,[5,6]	No	4-9	Yes	High. Songbirds, waterfowl, and small mammals.	Full to partial sun. Good nut crop every 2-3 years. Smooth gray bark.
Ash, white	<i>Fraxinus americana</i>	Tree	FACU	4,[5,6]	No	4-9	Yes	High. Food.	All sunlight conditions. Well drained soils. Grows to 100' tall.
Ash, black	<i>Fraxinus nigra</i>	Tree	FACW	3,4,5	Saturated		Yes	Moderate.	Rapid growth.
Ash, green	<i>Fraxinus pennsylvanica</i>	Tree	FACW	3,4,5	Seasonal	2-9	Yes	Moderate. Songbirds. Prolific seeder.	Rapid growing streambank stabilizer. Full sun to partial shade. Small tree 30-50' tall.
Holly, American	<i>Ilex opaca</i>	Tree	FACU	4,5,6	No	5-9	Yes	Moderate. Songbirds.	Full to partial sun. Shade tolerant. Evergreen. Attractive red fruits persist through winter.
Cedar, eastern red	<i>Juniperus virginiana</i>	tree	FACU	4,5,6	No	2-9	Yes	High. Songbirds and small mammals.	Full sun. Good wind break or screening plant. Early successional species. Evergreen.
Tuliptree	<i>Liriodendron tulipifera</i>	Tree	FACU	4,5,6	No	4-9	Yes	Moderate. Seeds and nest sites.	Full sun to partial shade. Well drained soils. Rapid growth. Grows to 120' tall.
Blackgum	<i>Nyssa sylvatica</i>	Tree	FACW+	2,[3,4],5	Seasonal	3-9	Yes	High. Songbirds, egrets, herons, raccoons, owls.	Can be difficult to transplant. Prefers sun to partial shade. Nice ornamental with deep red fall color.
Pine, pitch	<i>Pinus rigida</i>	Tree	FACU	4,5,6	No	4-7	Yes	High. Songbirds and small mammals.	Full sun. Old trees are fire resistant due to their thick bark. Grows well on poor sites. Evergreen.

Common Name	Scientific Name	Plant Type	Wetland Indicator	Hydrologic Zone	Inundation Tolerance	Hardiness Zone	Commercial Availability	Wildlife Value	Notes
Pine, eastern white	<i>Pinus strobus</i>	Tree	FACU	4,5,6	No	3-8	Yes	High. Songbirds and small mammals.	Full sun. Rapid growth. Large and long lived tree. Evergreen.
Sycamore, American	<i>Platanus occidentalis</i>	Tree	FACW-	[3,4],5	Seasonal	4-9	Yes	Low. Food, cavities for nesting.	Rapid growth. Common in floodplains and alluvial woodlands. Drought tolerant.
Cotton-wood, eastern	<i>Populus deltoides</i>	Tree	FAC	[3,4],5	Seasonal	2-9	Yes	Moderate. Cover, food.	Shallow rooted, subject to windthrow. Invasive roots. Will grow on dry sites. Weak wooded. Rapid growth.
Aspen, big-tooth	<i>Populus grandidentata</i>	Tree	FACU	[4,5,6]	No		Yes	Moderate. Ruffed Grouse eats buds and catkins.	Rapid growing and short lived (40-50 years).
Aspen, quaking	<i>Populus tremuloides</i>	Tree	FACU	[4,5],6	Seasonal	1-7	Yes	Moderate. Buds and some nesting.	Nice fall color. Short lived tree.
Cherry, black	<i>Prunus serotina</i>	Tree	FACU	[4,5],6	No	2-8	Yes	High. Food.	Moist soils or wet bottomland areas. Excellent fruit production. Early successional species.
Oak, white	<i>Quercus alba</i>	Tree	FACU	4,5,6	No	3-9	Yes	High. Songbirds and small mammals.	Full to partial sun. Slow growing. Longest lived tree in the northeast.
Oak, swamp white	<i>Quercus bicolor</i>	Tree	FACW+	2,[3,4],5	Seasonal	4-8	Yes	High. Songbirds, waterfowl and small mammals.	Full sun to partial shade. Good bottomland tree. Drought tolerant. Nice ornamental.
Oak, scarlet	<i>Quercus coccinea</i>	Tree	NI	5,6	No	4-9	Yes	High. Songbirds and small mammals.	Full to partial sun. Rapid growing and long lived. Nice fall color.
Oak, pin	<i>Quercus palustris</i>	Tree	FACW	[3],4,5,6	Seasonal	4-8	Yes	High. Songbirds and small mammals.	Gypsy moth target.
Oak, willow	<i>Quercus phellos</i>	Tree	FAC+	[3,4],5	Seasonal	5-9	Yes	High. Songbirds, waterfowl, and small mammals.	Full to partial sun.
Oak, red	<i>Quercus rubra</i>	Tree	FACU-	5,6	No	3-8	Yes	High. Small mammals.	Full to partial sun. Rapid growing and long lived. Valuable timber tree.
Willow, black	<i>Salix nigra</i>	Tree	FACW+	[2,3],4	Seasonal		Yes	High. Browsing and cavity nesters.	Rapid growth, stabilizes streambanks. Full sun. Roots easily from cuttings.
Bald Cypress	<i>Taxodium distichum</i>	Tree	OBL	1,[2,3],4	Saturated, 0-2	4-9	Yes	Little food value, but good perching site for waterfowl.	Tolerates drought.
Basswood, American	<i>Tilia americana</i>	Tree	FACU	[4,5],6	No	2-8	Yes	Moderate. Butterflies, songbirds, small mammals, and beneficial insects.	Partial sun. Shade tolerant. Important pollen source for honey bees.
Serviceberry, downy	<i>Amelanchier arborea</i>	Tree (small)	FAC-	3,[4,5],6	Seasonal	4-9	Yes	Moderate. songbirds and small mammals.	Partial sun. Shade tolerant. Very early spring flowers. Handsome tree.
Serviceberry, shadbush	<i>Amelanchier canadensis</i>	Tree (small)	FAC	4,5,6	Seasonal	4-7	Yes	High. Nesting, cover, food. Birds and mammals.	Prefers partial shade. Common in forested wetlands and upland woods. Very early spring flowers.
Hackberry, common	<i>Celtis occidentalis</i>	Tree (small)	FACU	4,5,6	No	3-9	Yes	High. Food and cover.	Full sun to partial shade. Small tree 30-50' tall. Fruit persists into winter.
Redbud, eastern	<i>Cercis canadensis</i>	Tree (small)	FACU-	4,5,6	No	4-9	Yes	Moderate. Butterflies, songbirds, and small mammals.	Partial sun. Shade tolerant. Nitrogen fixer. Nice ornamental.
Hackberry, common	<i>Celtis occidentalis</i>	Tree (small)	FACU	4,5,6	No	3-9	Yes	High. Food and cover.	Full sun to partial shade. Small tree 30-50' tall. Fruit persists into winter.
Redbud, eastern	<i>Cercis canadensis</i>	Tree (small)	FACU-	4,5,6	No	4-9	Yes	Moderate. Butterflies, songbirds, and small mammals.	Partial sun. Shade tolerant. Nitrogen fixer. Nice ornamental.
Dogwood, flowering	<i>Cornus florida</i>	Tree (small)	FACU-	4,5,6	No	5-9	Yes	High. Songbirds, waterfowl, and small mammals. Fruits eaten by >100 species of bird.	Partial sun to shade. Understory plant in hardwood forests. Nice ornamental.
Magnolia, sweetbay	<i>Magnolia virginiana</i>	Tree (small)	FACW+	[3,4],5	Seasonal		Yes	Moderate. Seeds.	Southeast part of state. Shade and drought tolerant. Attractive and fragrant flowers.



---

# Pennsylvania Stormwater Best Management Practices Manual

---

## Appendix C – Site Evaluation and Soil Testing







## Protocol 1 Site Evaluation and Soil Infiltration Testing

### A. Purpose of this Protocol

The purpose of the *Site Evaluation and Soil Infiltration Testing Protocol* is to describe evaluation and field testing procedures to:

- a. Determine if Infiltration BMPs are suitable at a site, and at what locations.
- b. Obtain the required data for infiltration BMP design.

### B. When to Conduct Testing

Designers are encouraged to conduct the Soil Evaluation and Investigation early in the site planning and design process. The Site Development process outlined in Chapters 4 and 5 of this Manual describe a process for site development and BMPs. Soil Evaluation and Investigation should be conducted early in the preliminary design of the project so that information developed in the testing process can be incorporated into the design. Adjustments to the design can be made as necessary. It is recommended that Soil Evaluation and Investigation be conducted following the development of an early Preliminary Plan. The Designer should possess a preliminary understanding of potential BMP locations prior to testing. Prescreening test may be carried out in advance to site potential BMP locations.

### C. Who Should Conduct Testing

Qualified professionals who can substantiate by qualifications/experience their ability carry out the evaluation should conduct test pit soil evaluations. A professional, experienced in observing and evaluating soils conditions is necessary to ascertain conditions that might affect BMP performance, which can not be thoroughly assessed with the testing procedures. Such professionals must conduct these evaluations in risk areas, or areas indicated in the guidance as non-preferred locations for testing or BMP implementation.

### D. Importance of Stormwater BMP Areas

Sites are often defined as unsuitable for Infiltration BMPs and soil based BMPs due to proposed grade changes (excessive cut or fill) or lack of suitable areas. Many sites will be constrained and unsuitable for infiltration BMPs. However, if suitable areas exist, these areas should be identified early in the design process and should not be subject to a building program that precludes infiltration BMPs. An exemption should not be provided for “full build-outs” where suitable soils otherwise exist for infiltration.

### E. Safety

As with all field work and testing, attention should be given to all applicable OSHA regulations and local guidelines related to earthwork and excavation. Digging and excavation should never be conducted without adequate notification through the Pennsylvania One Call system (**PA OneCall** 1-800-242-1776 or [www.paonecall.org](http://www.paonecall.org)). Excavations should never be left unsecured and unmarked, and all applicable authorities should be notified prior to any work.

## INFILTRATION TESTING: A MULTI-STEP PROCESS

Infiltration Testing is a four-step process to obtain the necessary data for the design of the stormwater management plan. The four steps include:

1. Background Evaluation
  - Based on available published and site specific data
  - Includes consideration of proposed development plan
  - Used to identify potential BMP locations and testing locations
  - Prior to field work (desktop)
  - On-site screening test
2. Test Pit (Deep Hole) Observation
  - Includes Multiple Testing Locations
  - Provides an understanding of sub-surface conditions
  - Identifies limiting conditions
3. Infiltration Testing
  - Must be conducted on-site
  - Different testing methods available
  - Alternate methods for - additional-Screening and Verification testing
4. Design Considerations
  - Determination of a suitable infiltration rate for design calculations
  - Consideration of BMP drawdown
  - Consideration of peak rate attenuation

### Step 1. Background Evaluation

Prior to performing testing and developing a detailed site plan, existing conditions at the site should be inventoried and mapped including, but not limited to:

- Existing mapped individual soils and USDA Hydrologic Soil Group classifications.
- Existing geology, including the location of any dikes, faults, fracture traces, solution cavities, landslide prone strata, or other features of note.
- Existing streams (perennial and intermittent, including intermittent swales), water bodies, wetlands, hydric soils, floodplains, alluvial soils, stream classifications, headwaters and 1<sup>st</sup> order streams.
- Existing topography, slope, and drainage patterns.
- Existing and previous land uses.
- Other natural or man-made features or conditions that may impact design, such as past uses of site, existing nearby structures (buildings, walls), etc.

A sketch plan or preliminary layout plan for development should be evaluated, including:

- The preliminary grading plan and areas of cut and fill.
- The location and water surface elevation of all existing and location of proposed water supply sources and wells.
- The location of all existing and proposed on-site wastewater systems.
- The location of other features of note such as utility right-of-ways, water and sewer lines, etc.
- Existing data such as structural borings, drillings, and geophysical testing.

- The proposed location of development features (buildings, roads, utilities, walls, etc.). In Step 1, the Designer should determine the potential location of infiltration BMPs. The approximate location of these BMPs should be located on the proposed development plan and should serve as the basis for the location and number of tests to be performed on-site.

**Important:** If the proposed development program is located on areas that may otherwise be suitable for BMP location, or if the proposed grading plan is such that potential BMP locations are eliminated, the Designer is *strongly* encouraged to revisit the proposed layout and grading plan and adjust the development plan as necessary. Full build-out of areas suitable for infiltration BMPs should *not* preclude the use of BMPs for volume reduction and groundwater recharge.

**Step 2. Test Pits (Deep Holes)**

A Test Pit (Deep Hole) allows visual observation of the soil horizons and overall soil conditions both horizontally and vertically in that portion of the site. An extensive number of Test Pit observations can be made across a site at a relatively low cost and in a short time period. The use of soil borings as a substitute for Test Pits strongly is discouraged, as visual observation is narrowly limited in a soil boring and the soil horizons cannot be observed in-situ, but must be observed from the extracted borings. Borings and other procedures, however, might be suitable for initial screening to develop a preliminary plan for testing, or verification testing.

A Test Pit consists of a backhoe-excavated trench, 2-1/2 to 3 feet wide, to a depth of between 72 inches and 90 inches, or until bedrock or fully saturated conditions are encountered. The trench should be benched at a depth of 2-3 feet for access and/or infiltration testing.

At each Test Pit, the following conditions shall be noted and described. Depth measurements should be described as depth below the ground surface:

- \_\_\_ Soil Horizons (upper and lower boundary)
- \_\_\_ Soil Texture and Color for each horizon
- \_\_\_ Color Patterns (mottling) and observed depth
- \_\_\_ Depth to Water Table
- \_\_\_ Depth to Bedrock
- \_\_\_ Observance of Pores or Roots (size, depth)
- \_\_\_ Estimated Type and Percent Coarse Fragments
- \_\_\_ Hardpan or Limiting Layers
- \_\_\_ Strike and dip of horizons (especially lateral direction of flow at limiting layers)

— Additional comments or observations

The Sample Soil Log Form at the end of this protocol may be used for documentation of each Test Pit.

At the Designer's discretion, soil samples may be collected at various horizons for additional analysis. Following testing, the test pits should be refilled with the original soil and the surface replaced with the original topsoil. A Test Pit should *never* be accessed if soil conditions are unsuitable for safe entry, or if site constraints preclude entry. OSHA regulations should always be observed.

It is important that the Test Pit provide information related to conditions at the bottom of the proposed Infiltration BMP. If the BMP depth will be greater than 90 inches below existing grade, deeper excavation will be required. However, *such depths are discouraged, especially in Karst topography*. Except for surface discharge BMPs (filter strips, etc.) the designer is cautioned regarding the proposal of systems that are significantly lower than the existing topography. The suitability for infiltration may decrease, and risk factors are likely to increase. *Locations that are not preferred* for testing *and* subsurface infiltration BMPs include swales, the toe of slopes for most sites, and soil mantels of less than three feet in Karst topography.

The designer and contractors should reducing grading and earthwork as needed to reduce site disturbance and compaction so that a greater opportunity exists for testing and stormwater management.

The number of Test Pits varies depending on site conditions and the proposed development plan. General guidelines are as follows:

- For single-family residential subdivisions with on-lot BMPs, one test pit per lot is recommended, preferably within 25 feet of the proposed BMP area. Verification testing should take place when BMPs are sited at greater distances.
- For multi-family and high density residential developments, one test pit per BMP area or acre is recommended.
- For large infiltration areas (basins, commercial, institutional, industrial, and other proposed land uses), multiple test pits should be evenly distributed at the rate of four (4) to six (6) tests per acre of BMP area.

The recommendations above are guidelines. Additional tests should be conducted if local conditions indicate significant variability in soil types, geology, water table levels, bedrock, topography, etc. Similarly, uniform site conditions may indicate that fewer test pits are required. Excessive testing and disturbance of the site prior to construction is not recommended.

### **Step 3. Infiltration Tests/Permeability Tests**

A variety of field tests exist for determining the infiltration capacity of a soil. Laboratory tests are strongly discouraged, as a homogeneous laboratory sample does not represent field conditions. Infiltration tests should be conducted in the field. Tests should not be conducted in the rain or within 24 hours of significant rainfall events (>0.5 inches), or when the temperature is below

freezing. However, the preferred testing *is* between January and June, the wet season. This is the period when infiltration is likely to be diminished by saturated conditions. Percolation tests carried out between June 1 and December 31 should use a 24 hour presoaking before the testing. This procedure is not required for Infiltrometer testing, or permeometer testing

At least one test should be conducted at the proposed bottom elevation of an infiltration BMP, and a minimum of two tests per Test Pit is recommended. More tests may be warranted if the results for first two tests are substantially different. The highest rate (inches/hour) for test results should be discarded when more than two are employed for design purposes. The geometric mean should be used to determine the average rate following multiple tests.

Based on observed field conditions, the Designer may elect to modify the proposed bottom elevation of a BMP. Personnel conducting Infiltration Tests should be prepared to adjust test locations and depths depending upon observed conditions.

Methodologies discussed in this protocol include:

- Double-ring Infiltrometer tests.
- Percolation tests (such as for on-site wastewater systems and described in Pa Code Chapter 73).

There are differences between the two methods. A Double-ring Infiltrometer test estimates the vertical movement of water through the bottom of the test area. The outer ring helps to reduce the lateral movement of water in the soil. A percolation test allows water movement through both the bottom and sides of the test area. For this reason, the measured rate of water level drop in a percolation test must be adjusted to represent the discharge that is occurring on both the bottom and sides of the percolation test hole.

For *infiltration basins*, it is *strongly* advised that an Infiltration Test be carried out with an infiltrometer (not percolation test) to determine the saturated hydraulic conductivity rate. This precaution is taken to account for the fact that only the surface of the basin functions to infiltrate, as measured by the test. Alternatively, permeability test procedures that yield a saturated hydraulic conductivity rate can be used (see formulas developed by Elrick and Reynolds (1992), or others for computation of hydraulic conductivity and saturated hydraulic conductivity).

Other testing methodologies and standards that are available but not discussed in detail in this protocol include (but are not limited to):

- Constant head double-ring infiltrometer
- Testing as described in the Maryland Stormwater Manual Appendix D.1 using 5-inch diameter casing.
- ASTM 2003 Volume 4.08, Soil and Rock (I): Designation D 3385-03, Standard Test Method for Infiltration Rate of Soils in Field Using a Double-Ring Infiltrometer.
- ASTM 2002 Volume 4.09, Soil and Rock (II): Designation D 5093-90, Standard Test Method for Field Measurement of Infiltration Rate Using a Double-Ring Infiltrometer with a Sealed-Inner Ring.
- Guelph Permeameter
- Constant Head Permeameter (Amoozemeter)

### **a. Methodology for Double-Ring Infiltrometer Field Test**

A Double-ring Infiltrometer consists of two concentric metal rings. The rings are driven into the ground and filled with water. The outer ring helps to prevent divergent flow. The drop in water level or volume in the inner ring is used to calculate an infiltration rate. The infiltration rate is determined as the amount of water per surface area and time unit that penetrates the soils. The diameter of the inner ring should be approximately 50% to 70% of the diameter of the outer ring, with a minimum inner ring size of 4-inches, preferably much larger. (Bouwer, 1986). Double-ring infiltrometer testing equipment that is designed specifically for that purpose may be purchased. However, field testing for stormwater BMP design may also be conducted with readily available materials.

#### Equipment for Double-Ring Infiltrometer Test:

- \_\_\_ Two concentric cylinder rings 6-inches or greater in height. Inner ring diameter equal to 50% - 70% of outer ring diameter (i.e., an 8-inch ring and a 12-inch ring). Material typically available at a hardware store may be acceptable.
- \_\_\_ Water supply
- \_\_\_ Stopwatch or timer
- \_\_\_ Ruler or metal measuring tape
- \_\_\_ Flat wooden board for driving cylinders uniformly into soil
- \_\_\_ Rubber mallet
- \_\_\_ Log sheets for recording data

#### Procedure for Double-Ring Infiltrometer Test

- \_\_\_ Prepare level testing area.
- \_\_\_ Place outer ring in place; place flat board on ring and drive ring into soil to a minimum depth of two inches.
- \_\_\_ Place inner ring in center of outer ring; place flat board on ring and drive ring into soil a minimum of two inches. The bottom rim of both rings should be at the same level.
- \_\_\_ The test area should be presoaked immediately prior to testing. Fill both rings with water to water level indicator mark or rim at 30 minute intervals for 1 hour. The minimum water depth should be 4-inches. The drop in the water level during the

last 30 minutes of the presoaking period should be applied to the following standard to determine the time interval between readings:

- If water level drop is 2-inches or more, use 10-minute measurement intervals.
  - If water level drop is less than 2-inches, use 30-minute measurement intervals.
- \_\_\_ Obtain a reading of the drop in water level in the center ring at appropriate time intervals. After each reading, refill both rings to water level indicator mark or rim. Measurement to the water level in the center ring shall be made from a fixed reference point and shall continue at the interval determined until a minimum of eight readings are completed or until a stabilized rate of drop is obtained, whichever occurs first. A stabilized rate of drop means a difference of 1/4 inch or less of drop between the highest and lowest readings of four consecutive readings.
- \_\_\_ The drop that occurs in the center ring during the final period or the average stabilized rate, expressed as inches per hour, shall represent the infiltration rate for that test location.

**b. Methodology for Percolation Test**

Equipment for Percolation Test:

- \_\_\_ Post hole digger or auger
- \_\_\_ Water supply
- \_\_\_ Stopwatch or timer
- \_\_\_ Ruler or metal measuring tape
- \_\_\_ Log sheets for recording data
- \_\_\_ Knife blade or sharp-pointed instrument (for soil scarification)
- \_\_\_ Course sand or fine gravel
- \_\_\_ Object for fixed-reference point during measurement (nail, toothpick, etc.)

Procedure for Percolation Test

This percolation test methodology is based largely on the Pennsylvania Department of Environmental Protection (PADEP) criteria for on-site sewage investigation of soils (as described in Chapter 73 of the Pennsylvania Code). This should include the 24 hour presoak procedure between June 1 and December 31. The presoak is done primarily to simulate saturated conditions in the environment (generally Spring) and to minimize the influence of

unsaturated flow. If a presoak procedure is not employed between June 1 and December 31, then the rate reduction formula described by Elrick and Reynolds (1992), or Fritton, et al. (1986) is recommended to account for the influence of unsaturated conditions in the test.

Prepare level testing area.

- Prepare hole having a uniform diameter of 6 to 10 inches and a depth of 8 to 12-inches. The bottom and sides of the hole should be scarified with a knife blade or sharp-pointed instrument to completely remove any smeared soil surfaces and to provide a natural soil interface into which water may percolate. Loose material should be removed from the hole.
- (Optional) two inches of coarse sand or fine gravel may be placed in the bottom of the hole to protect the soil from scouring and clogging of the pores.
- Test holes should be presoaked immediately prior to testing. Water should be placed in the hole to a minimum depth of 6 inches over the bottom and readjusted every 30 minutes for 1 hour.
- The drop in the water level during the last 30 minutes of the final presoaking period should be applied to the following standard to determine the time interval between readings for each percolation hole:
  - If water remains in the hole, the interval for readings during the percolation test should be 30 minutes.
  - If no water remains in the hole, the interval for readings during the percolation test may be reduced to 10 minutes.
- After the final presoaking period, water in the hole should again be adjusted to a minimum depth of 6-inches and readjusted when necessary after each reading. A nail or marker should be placed at a fixed reference point to indicate the water refill level. The water level depth and hole diameter should be recorded.
- Measurement to the water level in the individual percolation holes should be made from a fixed reference point and should continue at the interval determined from the previous step for each individual percolation hole until a minimum of eight readings are completed or until a stabilized rate of drop is obtained, whichever occurs first. A stabilized rate of drop means a difference of 1/4 inch or less of drop between the highest and lowest readings of four consecutive readings.
- The drop that occurs in the percolation hole during the final period, expressed as inches per hour, shall represent the percolation rate for that test location.
- The average measured rate must be adjusted to account for the discharge of water from both the sides and bottom of the hole and to develop a representative infiltration rate. The average/final percolation rate should be adjusted for each percolation test according to the following formula:

$$\text{Infiltration Rate} = (\text{Percolation Rate}) / (\text{Reduction Factor})$$



Where the Reduction Factor is given by\*\*:

$$R_f = \frac{2d_1 - \Delta d}{DIA} + 1$$

With:

- d<sub>1</sub> = Initial Water Depth (in.)
- Δd = Average/Final Water Level Drop (in.)
- DIA = Diameter of the Percolation Hole (in.)

The Percolation Rate is simply divided by the Reduction Factor as calculated above or shown in the table below to yield the representative Infiltration Rate. In most cases, the Reduction Factor varies from about 2 to 4 depending on the percolation hole dimensions and water level drop – wider and shallower tests have lower Reduction Factors because proportionately less water exfiltrates through the sides. For design purposes additional safety factors are employed (see Protocol 2, Infiltration Systems Design and Construction Guidelines)

*\*\* The area Reduction Factor accounts for the exfiltration occurring through the sides of percolation hole. It assumes that the percolation rate is affected by the depth of water in the hole and that the percolating surface of the hole is in uniform soil. If there are significant problems with either of these assumptions then other adjustments may be necessary.*

Perc. Hole Diameter, DIA (in.)	Initial Water Depth, $d_1$ (in.)	Ave./Final Water Level Drop, $\Delta d$ (in.)	Reduction Factor, $R_f$
6	6	0.1	3.0
		0.5	2.9
		2.5	2.6
	8	0.1	3.7
		0.5	3.6
		2.5	3.3
	10	0.1	4.3
		0.5	4.3
		2.5	3.9
8	6	0.1	2.5
		0.5	2.4
		2.5	2.2
	8	0.1	3.0
		0.5	2.9
		2.5	2.7
	10	0.1	3.5
		0.5	3.4
		2.5	3.2
10	6	0.1	2.2
		0.5	2.2
		2.5	2.0
	8	0.1	2.6
		0.5	2.6
		2.5	2.4
	10	0.1	3.0
		0.5	3.0
		2.5	2.8

**Table 1. Sample Percolation Rate Adjustments**

**Step 4. Design Considerations beginning with *Protocol 2 – Infiltration System Design and Construction Guidelines***

**ADDITIONAL POSSIBLE TESTING - BULK DENSITY, OTHERS**

Other testing methods are acceptable to assess a soil's suitability for infiltration for early screening and occasionally for verification. They can be especially helpful where consultants wish to cull out the better soils. Percolation testing can also be performed without presoaking as a *pre*-screening procedure.

Alternate tests or investigations can be used for verification. For instance, if the BMPs are not located precisely over the test locations, alternate testing or investigations can be used to verify that the soils are the same as the soils that yielded the earlier test results. However, consultants should document these verification test results or investigations. Professionals with substantiated qualifications should carry out verification procedures.

Bulk Density Tests measure the level of compaction of a soil, which is an indicator of a soils' ability to absorb rainfall. Developed and urbanized sites often have very high bulk densities and therefore possess limited ability to absorb rainfall (and have high rates of stormwater runoff). Vegetative and soil improvement programs can improve, (i.e. lower), the soil bulk density and improve the site's ability to absorb rainfall and reduce runoff.

Macropores occur primarily in the upper soil horizons and are formed by plant roots (both living and decaying), soil fauna such as insects, the weathering processes caused by the movement of water, the freeze-thaw cycle, soil shrinkage due to desiccation of clays, chemical processes, and other mechanisms. These macropores provide an important mechanism for infiltration prior to development, extending vertically and horizontally for considerable distances. It is the intent of good engineering and design practice to maintain these macropores in the installation of Infiltration BMPs as much as possible. Bulk Density Tests can help determine the relative compaction of soils before and after site disturbance and/or restoration and should be used at the discretion of the designer/reviewer.

Various procedures are available to conduct bulk density tests. The density measurements should be carried out in conjunction with a soil texture analysis. Sandy soils infiltrate well, but tend to have a somewhat higher bulk density than finer soils. Experienced personnel can do the texture analysis manually on site.

**Sample Soil Log**

Tested by: \_\_\_\_\_ Date: \_\_\_\_\_ Equipment Used: \_\_\_\_\_  
 Test Pit: \_\_\_\_\_ Soil Type: \_\_\_\_\_ Elevation: \_\_\_\_\_  
 Geology: \_\_\_\_\_ Land Use: \_\_\_\_\_ Weather: \_\_\_\_\_

Additional comments:

Horizon	Upper Boundary	Lower Boundary	Soil Textural Class	Type, Size, Coarse Fragments, etc.	Soil Color	Color Patterns	Pores, Roots, Rock Structure	Depth to Bedrock	Depth to Water	Comments

## Protocol 2 Infiltration Systems Design and Construction Guidelines

### Role of Infiltration BMPs

The phrase “infiltration BMPs” describes a wide range of stormwater management practices aimed at infiltrating some fraction of stormwater runoff from developed surfaces into the soil horizon and eventually into deeper groundwater. In this manual the major infiltration strategies are grouped into four categories or types, based on construction and performance similarities:

- Surface Infiltration Basins
- Subsurface Infiltration Beds
- Bioretention Areas/Rain Gardens
- Other BMPs that support infiltration (vegetated filter/buffer strips, level spreaders, and vegetated swales)

Infiltration BMPs are one of the most beneficial approaches to stormwater management for a variety of reasons including:

- Reduction of the peak rate of runoff
- Reduction of the volume of runoff
- Removal of a significant portion of the particulate-associated pollutants and some portion of the solute pollutants.
- Recharge of groundwater and maintenance of stream baseflow.

Infiltration BMPs attempt to replicate the natural hydrologic regime. During periods of rainfall, infiltration BMPs reduce the volume of runoff and help to mitigate potential flooding events. During periods of reduced rainfall, this recharged water serves to provide baseflow to streams and maintain in-stream water quality. Qualitatively, infiltration BMPs are known to remove nonpoint source pollutants from runoff through a complex mix of physical, chemical, and biological removal processes. Infiltration promotes maintenance of the natural temperature regimes of stream systems (cooler in summer, warmer in winter), which can be critical to the aquatic ecology. Because of the ability of infiltration BMPs to reduce the volume of runoff, there is also a corresponding reduction in erosive “bankfull” conditions and downstream erosion and channel morphology changes.

Infiltration BMPs are designed to infiltrate some portion of runoff during every runoff event. During small storm events, a large percentage of the runoff may infiltrate, whereas during large storm events, the volume that infiltrates may only be a small portion of the total runoff. However, because most of the rainfall in Pennsylvania occurs in small (less than 1-inch) rainfalls, the annual benefits of an infiltration system may be significant.

## Purpose of Protocol 2: Infiltration Systems Guidelines

The purpose of this protocol is to provide the designer with specific guidelines for the successful construction and long-term performance of Infiltration BMPs. These guidelines fall into three categories:

1. Site conditions and constraints
2. Design considerations
3. Construction requirements

All of these guidelines are important, and successful infiltration is dependent on careful consideration of site conditions, careful design, and careful construction.

### 1. SITE CONDITIONS and CONSTRAINTS

- a) It is desirable to **maintain a 2-foot clearance above regularly occurring seasonally high water table**. This reduces the likelihood that temporary groundwater mounding will affect the system, and allows sufficient distance of water movement through the soil to allow adequate pollutant removal. Some minor exceptions for very shallow systems and on grade systems, filter strips, buffers, etc.
- b) **Maintain a minimum depth to bedrock of 2-feet to assure adequate pollutant removal**. In special circumstances, filter media may be employed to remove pollutants if adequate soil mantle does not exist.
- c) It is desired that **soils underlying infiltration devices should have infiltration rates between 0.1 and 10 inches per hour**, which in most development programs should result in reasonably sized infiltration systems. Where soil permeability is extremely low, infiltration may still be possible but the surface area required could be large, and other volume reduction methods may be warranted. Undisturbed Hydrologic Soil Groups B and C often fall within this range and cover most of the state. Soils with rates in excess of 6.0 inches per hour may require an additional soil buffer (such as an organic layer over the bed bottom) if the Cation Exchange Capacity (CEC) is less than 5 and pollutant loading is expected to be significant. In carbonate soils, excessively rapid drainage may increase the risk of sinkhole formation, and some compaction or additional soil may be appropriate.
- d) **Infiltration BMPs should be sited so that any risk to groundwater quality is minimized**, at least 50 feet from individual water supply wells, and 100 feet from community or municipal water supply wells. Horizontal separation distances or buffers may also be appropriate from Special Geologic Features, such as fractures traces and faults, depending on water supply sources.
- e) **Infiltration BMPs should be sited so that they present no threat to sub-surface structures**, at least 10 feet down gradient or 100 feet up gradient from building basement foundations, and 50 feet from septic system drain fields unless specific circumstances allow for reduced separation distances.

In general, soils of Hydrologic Soil Group D will not be suitable for infiltration. Similarly, areas of floodplains and areas of close proximity to wetlands and streams will generally not be suitable

for infiltration (due to high water table and/or low permeability). In developing areas that were previously used for agricultural purposes, the designer should consider the past patterns of land use. Areas that were suitable for cultivation will likely be suitable for some level of infiltration. Areas that were left out of cultivation often indicate locations that are too wet or too rocky, and will likely not be suitable for infiltration.

## 2. DESIGN CONSIDERATIONS

- a) **Do Not Infiltrate in Compacted Fill.** Infiltration in native soil without prior fill or disturbance is preferred but not always possible. Areas that have experienced historic disturbance or fill are suitable for infiltration provided sufficient time has elapsed and the Soil Testing indicates the infiltration is feasible. In disturbed areas it may be necessary to infiltrate at a depth that is beneath soils that have previously been compacted by construction methods or long periods of mowing, often 18-inches.
- b) **A Level Infiltration Area (1% or less slope) is preferred.** Bed bottoms should always be graded into the existing soil mantle, with terracing as required to construct flat structures. Sloped bottoms tend to pool and concentrate water in small areas, reducing the overall rate of infiltration and longevity of the BMP. Infiltration areas should be flat, nearly so, or on contour.
- c) **The soil mantle should be preserved to the maximum extent possible,** and excavation should be minimized. Those soils that do not need to be disturbed for the building program should be left undisturbed. Macropores can provide a significant mechanism for water movement in infiltration systems, and the extent of macropores often decreases with depth. Maximizing the soil mantle also increases the pollutant removal capacity and reduces concerns about groundwater mounding. Therefore, excessive excavation for the construction of infiltration systems is strongly discouraged.
- d) **Isolate “hot spot areas”.** Site plans that include ‘hot spots’ need to be considered. ‘Hot spots’ are most often associated with some industrial uses and high traffic – gasoline stations, vehicle maintenance areas, and high intensity commercial uses (fast food restaurants, convenience stores, etc.). These “hot spots” are defined in Section 3.3, Stormwater Standards for Special Areas. Infiltration may occur in areas of hot spots provided pretreatment is suitable to address concerns. Pretreatment requirements need to be analyzed, especially for ‘hot spots’ and areas that produce high sediment loading. Pretreatment devices that operate effectively in conjunction with infiltration include grass swales, vegetated filter strips, settling chambers, oil/grit separators, constructed wetlands, sediment sumps, and water quality inserts. The pollutants of greatest concern, site by site, should guide selection of pretreatment depending upon the nature and extent of the land development under consideration. Selection of pretreatment techniques will vary depending upon whether the pollutants are of a particulate (sediment, phosphorus, metals, etc.) versus soluble (nitrogen and others) nature. Types of pretreatment (i.e., filters) should be matched with the nature of the pollutants expected to be generated.
- e) **The Loading Ratio of impervious area to bed bottom area must be considered.** One of the more common reasons for infiltration system failure is the design of a system that attempts to infiltrate a substantial volume of water in a very small area. Infiltration

systems work best when the water is “spread out”. The Loading Ratio describes the ratio of impervious drainage area to infiltration area, or the ratio of total drainage area to infiltration area. In general, the following Loading Ratio guidelines are recommended:

- Maximum Impervious Loading Ratio of 5:1 relating impervious drainage area to infiltration area.
  - A Maximum Total Loading Ratio of 8:1 relating total drainage area to infiltration area.
  - Maximum Impervious Loading Ratio of 3:1 relating impervious drainage area to infiltration area for Karst areas.
- f) **The Hydraulic Head or Depth of Water should be limited.** The total effective depth of water should generally not be greater than two feet to avoid excessive pressure and potential sealing of the bed bottom. Typically the water depth is limited by the Loading Ratio and Drawdown Time and is not an issue.
- g) **Drawdown Time must be considered.** In general, infiltration BMPs should be designed so that they completely empty within the time period specified in Chapter 3.
- h) **All infiltration BMPs should be designed with a positive overflow** that discharges excess volume in a non-erosive manner, and allows for controlled discharge during extreme rainfall events or frozen bed conditions. Infiltration BMPs should never be closed systems dependent entirely upon infiltration in all situations.
- i) **Geotextiles should be incorporated into the design as necessary in certain infiltration BMPs.** Infiltration BMPs that are subject to soil movement and deposition must be constructed with suitably well-draining non-woven geotextiles to prevent to movement of fines and sediment into the infiltration system. The designer is encouraged to err on the side of caution and use geotextiles as necessary at the soil/BMP interface.
- j) Avoid severe slopes (>20%), and toes of slopes, where possible. Specific on-site investigations by experienced personnel need to be made to determine acceptability of each case.

### 3. CONSTRUCTION REQUIREMENTS

- a) **Do not compact soil infiltration beds during construction.** Prohibit all heavy equipment from the infiltration area and minimize all other traffic. Equipment should be limited to vehicles that will cause the least compaction, such as tracked vehicles.
- b) **Protect the infiltration area from sediment until the surrounding site is completely stabilized.** Methods to prevent sediment from washing into BMPs should be clearly shown on plans. Where geo-textile is used as a bed bottom liner, this should be extended several feet beyond the bed and folded over the edge to protect from sediment wash into the bed during construction, and then trimmed. Runoff from construction areas should never be allowed to drain to infiltration BMPs. This can usually be accomplished by diversion berms and immediate vegetative stabilization. The infiltration area may be used as a temporary sediment trap or basin during earlier stages of construction. However, if an infiltration area is also to be utilized as a temporary



sediment basin, excavation should be limited to within 1 foot of the final bottom invert of the infiltration BMP to prevent clogging and compacting the soil horizon, and final grade removed when the contributing site is fully stabilized. All infiltration BMPs should be finalized at the end of the construction process, when upstream soil areas have a dense vegetative cover.

- c) **Provide thorough construction oversight.** Long-term performance of infiltration BMPs is dependent on the care taken during construction. Plans and specifications must be followed precisely. The designer is encouraged to meet with the contractor to review the plans and construction sequence prior to construction, and to inspect the construction at regular intervals and prior to final acceptance of the BMP.
- d) **Provide Quality Control of Materials.** As with all BMPs, the final product is only as good as the materials and workmanship that went into it. The designer is encouraged to review and approve materials and workmanship, especially as related to aggregates, geotextiles, soil and topsoil, and vegetative materials.

### **BMP Effectiveness**

Infiltration BMPs produce excellent pollutant removal effectiveness because of the combination of a variety of natural functions occurring within the soil mantle, complemented by existing vegetation (where this vegetation is preserved). Soil functions include physical filtering, chemical interactions (e.g., ion exchange, adsorption), as well as a variety of forms of biological processing, conversion, and uptake. The inclusion of native vegetation for filter strips, rain gardens, and some vegetated infiltration basins, reinforces the work of the soil by reducing velocity and erosive forces, soil anchoring, and further uptake of nonpoint source pollutants. In some cases the more difficult-to-remove soluble nitrates can be reduced as well. It should be noted that infiltration BMPs tend to be excellent for removal of many pollutants, especially those that are in particulate form; however, there are limitations to the removal of highly solubilized pollutants, such as nitrate, which can be transmitted through the soil.

In addition to the removal of chemical pollutants, infiltration can address thermal pollution. Maintaining natural temperatures in stream systems is recognized as an issue of increasing importance for protection of overall stream ecology. Detention facilities tend to discharge heated runoff flows. The return of runoff to the groundwater through use of infiltration BMPs guarantees that these waters will be returned at natural groundwater temperatures, considerably cooler than ambient air in summer and warmer in winter, so that seasonal extreme fluctuations in stream water temperature are minimized. Fish, macroinvertebrates, and a variety of other biota will benefit as the result.

Although precise data on pollutant removal efficiencies is somewhat limited, infiltration BMPs have been shown to have excellent efficiencies for a wide range of pollutants. In fact, recent EPA guidance has suggested that infiltration BMPs can be considered 100 percent effective at removing pollutants from surface water for the fraction of water that infiltrates (EPA, 1999a). Other more conservative removals are reported in a variety of other sources. Estimated removals for all BMPs are contained in Section 9.

### **Fate of Infiltrated Contaminants**

The protection of groundwater quality is of utmost importance in any PA watershed. The potential to contaminate groundwater by infiltrating stormwater in properly designed and constructed BMPs with proper pretreatment is low, if some common sense rules are followed, as discussed above. Numerous studies have shown that stormwater infiltration BMPs have a minor risk of contaminating either groundwater or soil. Perhaps the most comprehensive research was conducted by the U.S. Environmental Protection Agency, summarized in "Potential Groundwater Contamination from Intentional and Nonintentional Stormwater Infiltration" (Pitt et al., 1994). The publication presents a summary table that identifies the potential of pollutants to contaminate groundwater as either low, low/moderate, moderate, or high. Of the 25 physical pollutants listed, only one has a "high" potential (chloride), and only two have even "moderate" potential (fluoranthene and pyrene) for polluting groundwater through the use of shallow infiltration systems with some sediment pretreatment. While chloride can be found in significant quantities due to winter salting, relatively high concentrations are generally safe for both humans and aquatic biota (in fact, chloride is not even included in U.S. EPA's primary drinking water standards and the secondary standard concentration is given as 250 mg/L at <http://www.epa.gov/safewater/mcl.html#mcls>). Pentachlorophenol, cadmium, zinc, chromium, lead, and all the pesticides listed are classified as having a "low" contamination potential. Even nitrate which is soluble and mobile (discussed further below) is only given a "low/moderate" potential.

Legret et al. (1999) simulated the long term effects of heavy metals in infiltrating stormwater and concluded that the "long-term pollution risks for both soil and groundwater are low," and "metals are generally well retained in the upper layers of the soil (0-20 cm) [0-8 inches]..." Barraud et al. (1999) studied a thirty year-old infiltration BMP and found that both metal and hydrocarbon concentrations in the soil under the infiltration device decreased rapidly with depth "to a low level after a few decimeters down [3 decimeters = 1 foot]..." A study concerning the infiltration of highway runoff (Dierkes and Geiger, 1999) found that polycyclic aromatic hydrocarbons (PAH) were effectively removed in the upper 4 inches of the soil and that runoff that had passed through 14 inches of soil met drinking water standards for cadmium, zinc, and copper. This extremely high pollutant removal and retention capacity of soils is the result of a multitude of natural processes including physical filtering, ion exchange, adsorption, biological processing, conversion, and uptake.

Several studies have also found that porous pavement and stone-filled subsurface infiltration beds can significantly reduce the pollutant concentrations (especially hydrocarbons and heavy metals) of stormwater runoff before it even reaches the underlying soil due to adsorption, filtering, sedimentation, and bio-degradation by a diverse microbial community in the pavement and infiltration beds (Legret and Colandini, 1999; Balades et al., 1995; Swisher, 2002; Newman et al., 2002; and Pratt et al., 1999).

### **Common Causes of Infiltration BMP "Failures"**

The concept of failure is simple – a design no longer provides the benefit or performance anticipated. With respect to stormwater infiltration BMPs, the term requires some qualification, since the net result of "failure" may be a reduction in the volume of runoff anticipated or the discharge of stormwater with excessive levels of some pollutants. Where the system includes built structures, such as porous pavements, failure may include loss of structural integrity for the wearing surface, whereas the infiltration function may continue uncompromised. For infiltration

systems with vegetated surfaces, such as play fields or rain gardens, failure may include the inability to support surface vegetation, caused by too much or too little water.

The primary causes of reduced performance appear to be:

- a) Poor construction techniques, especially soil compaction/smearing, which results in significantly reduced infiltration rates.
- b) A lack of site soil stabilization prior to the BMP receiving runoff, which greatly increases the potential for sediment clogging from contiguous land surfaces.
- c) Inadequate pretreatment, especially of sediment-laden runoff, which can cause a gradual reduction of infiltration rates.
- d) Lack of proper maintenance (erosion repair, re-vegetation, removal of detritus, catch basin cleaning, vacuuming of pervious pavement, etc.), which can reduce the longevity of infiltration BMPs.
- e) Inadequate design

Infiltration systems should always be designed such that failure of the infiltration component does not completely eliminate the peak rate attenuation capability of the BMP. Because infiltration BMPs are designed to infiltrate small, frequent storms, the loss or reduction of this capability may not significantly impact the storage and peak rate mitigation of the BMP during extreme events.

### Consideration of Infiltration Rate in Design and Modeling Application

For the purposes of site suitability, areas with tested soil infiltration rates as low as 0.1 inches per hour may be used for infiltration BMPs. However, in the design of these BMPs and the sizing of the BMP, the designer should incorporate a safety factor. Safety factors between 1 (no adjustment) and 10 have commonly been used in the design of stormwater infiltration systems, with a factor of two being recommended for most cases.

The minimum safety for design purposes that may used for any type of tests is two (2). For percolation tests this safety factor is only applicable for soils more coarse than a loam. It should be applied **after** (in addition to) using the reduction formula outlined in Protocol 1, Site Evaluation and Soil Infiltration Testing.

For Percolation tests in loams and finer soils (silty loam, clay loams, silty clay loams, sandy clay loams, clays) a minimum design safety factor of three (3) is recommended **after** using the reduction formula in Protocol 1, Site Evaluation and Soil Infiltration Testing. This higher factor is to account for the unwanted capillary suction force that can occur from *unsaturated* conditions during percolation testing.

Therefore, a percolation rate of 0.5 inches per hour (**after** reduction formula) should generally be considered as a rate of 0.25 inches per hour when designing an infiltration BMP for a sandy loam. The same rate for a loam would yield a *design* rate of 0.17 inches/hour.

For other test procedures a safety factor of 3 should also be considered for problem or less preferred locations, basins, swales, toe of slopes, loadings greater than 5:1 (drainage area to infiltration area) where saturated hydraulic conductivity rate (Ksat) was **not** determined (A raw infiltration rate was used. The Ksat rate will normally be less than the infiltration rate.)

As discussed in Section 9 of this Manual, infiltration systems can be modeled similarly to traditional detention basins. The marked difference with modeling infiltration systems is the inclusion of the infiltration rate, which can be considered as another outlet. For modeling purposes, it is convenient to develop infiltration rates that vary (based on the infiltration area provided as the system fills with runoff) for inclusion in the Stage-Storage-Discharge table.

## References

- Balades et al., 1995. "Permeable Pavements: Pollution Management Tools," *Water Science and Technology*. Vol. 32, No. 1, pp. 49-56, 1995.
- Barraud et al., 1999. "The Impact of Intentional Stormwater Infiltration on Soil and Groundwater," *Water Science and Technology*. Vol. 39, No. 2, pp. 185-192, 1999.
- Dierkes and Geiger, 1999. "Pollution Retention Capabilities of Roadside Soils," *Water Science and Technology*. Vol. 39, No. 2, pp. 201-208, 1999.
- Elrick, D.E. and W.D. Reynolds. 1992. Infiltration from constant-head well permeameters and infiltrometers. p. 1-24. In: Topp, G.C., W.D. Reynolds, and R. E. Green (eds.). Advances in measurement of the soil physical properties: Bringing theory into practice. Soil Society of America Publication Number 30. Soil Science Society of America, Inc., Madison, WI.
- Fritton, D.D., T.T. Ratvasky, and G. W. Peterson. 1986. Determination of saturated hydraulic conductivity from soil percolation test results. *Soil Sci. Soc. Am. J.* 50:273-276.
- Kessler, J., and Ooterbaan, R.J. 1974. Determining hydraulic conductivity of soils. Drainage principles and applications: III Surveys and investigations. Publ. No. 16. Wagenigen. The Netherlands: ILRI pp. 253-296.
- Legret and Colandini, 1999. "Effects of a Porous Pavement with Reservoir Structure on Runoff Water: Water Quality and Fate of Heavy Metals", *Water Science and Technology*. Vol. 39, No. 2, pp. 111-117, 1999.
- Legret et al., 1999. "Simulation of Heavy Metal Pollution from Stormwater Infiltration through a Porous Pavement with Reservoir Structure", *Water Science and Technology*. Vol. 39, No. 2, pp. 119-125, 1999.
- Newman et al., 2002. "Oil Bio-Degradation in Permeable Pavements by Microbial Communities," *Water Science and Technology*. Vol. 45, No. 7, pp. 51-56, 2002.

Pitt et al., 1994. *Potential Groundwater Contamination from Intentional and Nonintentional Stormwater Infiltration*, U.S. Environmental Protection Agency's Risk Reduction Engineering Laboratory, May 1994. EPA/600/SR-94/051.

Pratt et al., 1999. "Mineral Oil Bio-Degradation within a Permeable Pavement: Long Term Observations," *Water Science and Technology*. Vol. 39, No. 2, pp. 103-109, 1999.

Swisher, David. "Chemical and Hydraulic Performance of a Porous Pavement Parking Lot with Infiltration to Ground Water," Unpublished Master's Thesis, Department of Civil and Environmental Engineering, The Pennsylvania State University, 2002.



---

# **Pennsylvania Stormwater Best Management Practices Manual**

---

## **Appendix D – Stormwater Calculations and Methodology: Case Study**







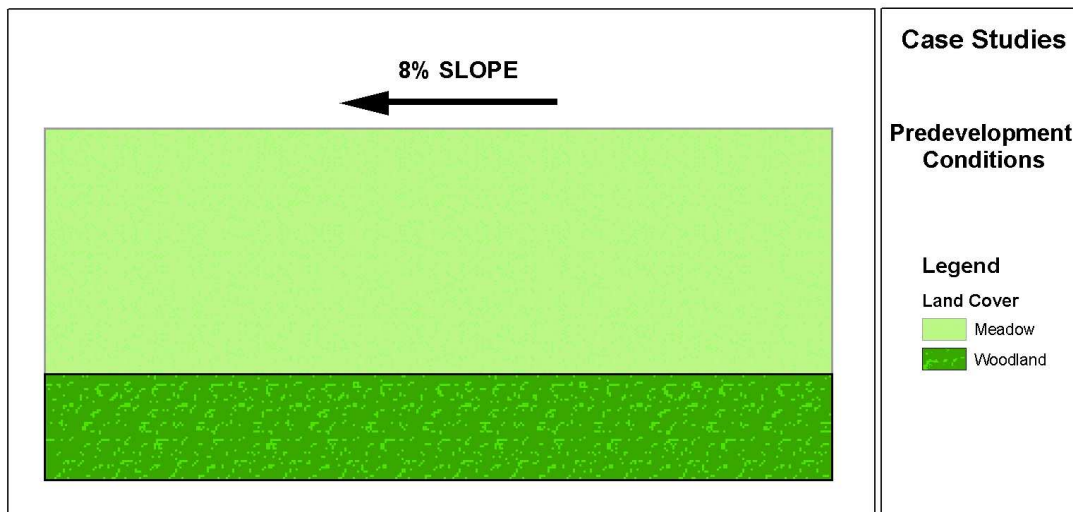
**EXAMPLE 1: Control Guideline 1 for Residential 10-Lot Subdivision**

This example describes a 10-lot residential subdivision in Blair County, Pennsylvania with the following conditions:

1. In this 10-lot subdivision, on-lot structural BMPs provide volume reduction and infiltration for the net increase in volume for the 2-year, 24-hour storm event. Peak rate calculations are developed by two different techniques. Because of the relatively slow-draining soils and a small total infiltration area, increased storage in the BMPs or downstream detention is required to mitigate the peak rate of runoff for the larger storm events.
2. The same design is then revised to incorporate Non-structural BMPs to reduce the requirements of the structural BMPs. Adjusted volume calculations are provided.
3. In addition, the 10-lot subdivision is modeled with a dry detention basin for conventional peak rate control for comparison. Finally, the site is routed with an extended detention (ED) basin for ED of the 1-year storm and peak rate control for the larger storms.

**Follow Flow Chart A**

- **Step 1:** Provide General Site Information (Worksheet 1)



In this example, the pre-development condition is a 10-acre site with 7 acres of meadow and 3 acres of woods. The underlying soils are classified as hydrologic group “C”, and the overall site slope is approximately 8%.

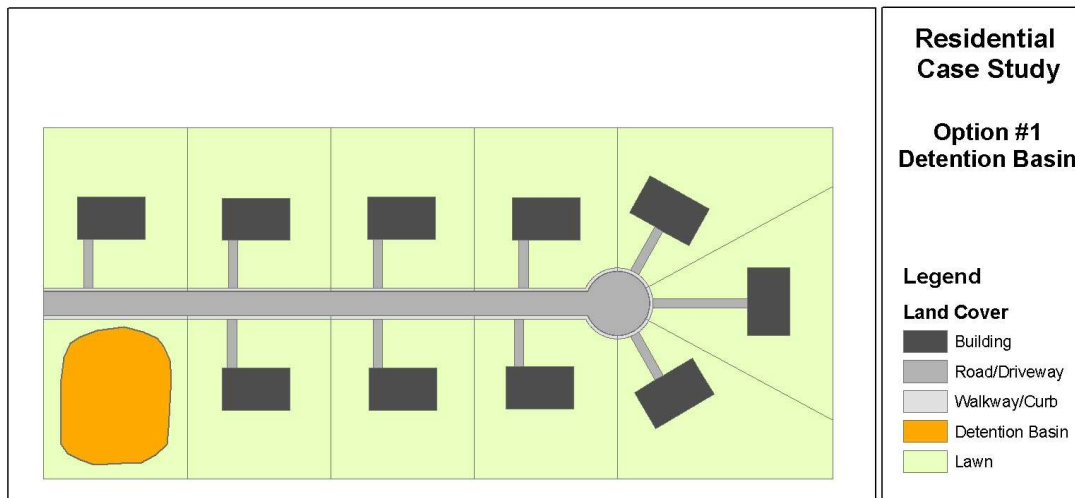
- **Step 2:** Identify sensitive natural resources (if applicable) and what areas will be protected or maintained. (Worksheet 2).

**Note:** *In this example, there are 3 acres of woodlands that are not protected.*

- **Step 3:** Estimate the benefits of Non-structural BMPs in the stormwater design (Worksheet 3).

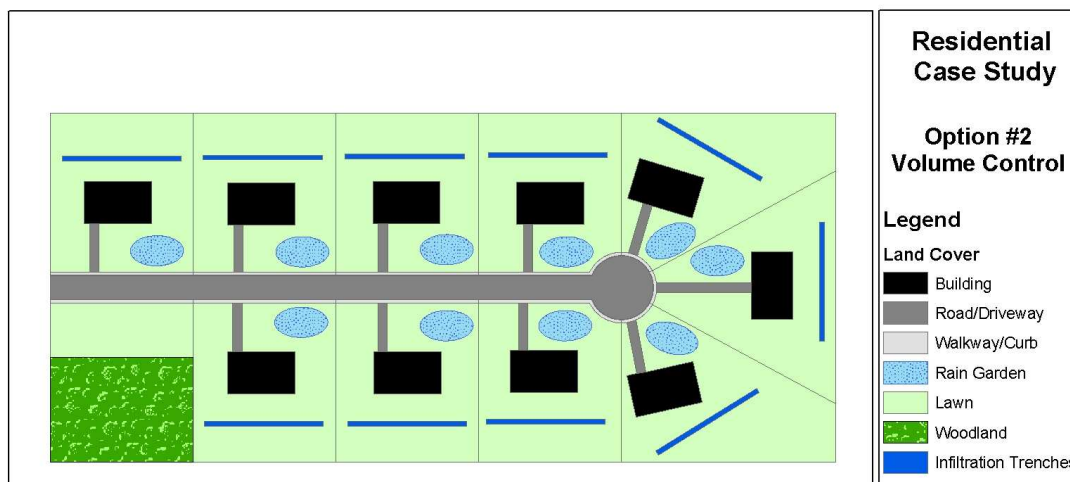
**Note:** In this example, Non-structural BMPs are not initially applied.

- **Step 4:** Based on the proposed design, estimate the increased volume of runoff for the 2-year storm event, using the Cover Complex Curve Number method. **Using a weighted curve number is NOT acceptable.** Runoff volume should be calculated based on major land use types and soil types (Worksheet 4).



The proposed development includes 10 residential lots, each covering 0.91 acres.

- **Step 5:** Design and incorporate Structural and Non-Structural BMPs that provide volume control for the 2-Year volume increase (Worksheet 5).



**Note:** In this example, Rain Gardens and Infiltration Trenches are placed on each lot.

Calculations are provided to demonstrate that the required volume is provided. The storage volume is calculated for each rain garden and infiltration trench. The total

volume is indicated on Worksheet 5 and compared to the volume requirement for CG1 of the net increase in runoff volume for the 2-year storm (Worksheet 4).

For this example, the net increase in runoff volume for the 2-year storm is approximately 25,913 ft<sup>3</sup>, and the combined storage provided by the rain garden and infiltration trench BMPs is approximately 26,020 ft<sup>3</sup>, so the volume requirement of CG1 has been met.

- **Step 6:** Demonstrate Peak Rate Control for the 2-year through 100-year events.
  - If Conditions for Peak Rate mitigation can be met, detailed Peak Rate Analysis and Flood Routing can be waived (Worksheet 6). This example does not meet those conditions because it has 2 acres of impervious cover. The maximum impervious area for a waiver is 1 acre.
  - If Conditions for Peak Rate mitigation cannot be met, detailed Peak Rate Analysis and Flood routing is required.

One of the challenges designers often face in using many BMPs throughout the site is that traditional engineering models and methods of peak rate calculation do not lend themselves to this type of design. As a result, designers often include BMPs for volume control, infiltration, or water quality, and then add detention measures. These detention measures may be greatly oversized because the volume-reduction and detention benefits of the BMPs and the effects of slowing the movement of runoff from the site are not accounted for. Chapter 8 provides a discussion titled “Guidelines: Volume Credits for Detention Routing” that proposes several options for considering the volume and rate mitigation benefits of multiple volume-reducing BMPs.

In this example, some of those techniques are applied, including: Composite BMP and Travel Time Adjustment with Volume Diversion.

For the Composite BMP example, the volume and discharge of the multiple BMPs (ten rain gardens and ten infiltration trenches) are combined to create a “synthetic” storage reservoir with a composite stage-storage-discharge curve. The post-development runoff hydrograph for the entire site is routed into the composite storage reservoir represented by the combined stage-storage-discharge characteristics of the many BMPs. The routed discharge from this “synthetic reservoir” is then used to size the required detention facility for the site to meet the peak rate attenuation requirements of the 1- to 100- year storm events. This method allows the designer to “take credit” for the storage/detention volume and infiltration occurring in the many BMPs, and to reduce the size of the downstream detention facility that will be built. The method is limited because it does not provide adequate consideration of the effect that many BMPs have on how fast water travels from and across the site. Since the peak of the runoff hydrograph is strongly influenced by how fast water travels across the site (or the Time of Concentration,  $T_c$ ), this method is somewhat conservative.

For the Travel Time Adjustment example, the post-development Time of Concentration ( $T_c$ ) is increased to take into consideration the amount of time it takes for runoff to move through the various BMPs. Both structural and non-structural

BMPs can significantly slow the movement of water and reduce the peak flow rate. In this approach, the total storage of the volume-reduction BMPs (in cubic feet) is divided by the peak flow rate (calculated without the BMPs in place, in cubic feet per second) for the 100-year storm event to estimate how long it will take for water to move “through” the BMPs. This estimated time where runoff is essentially slowed by the BMP is added to the original post-development  $T_c$  in determining the post-development runoff hydrograph. Because the  $T_c$  increases, the calculated peak rate of flow for the site will be lower and the required downstream detention facility will be smaller. To account for the actual storage and infiltration of the volume-reducing BMPs (trenches and rain gardens), a diversion is incorporated into the modeling framework.

## Residential 10 Lot Subdivision – Part 2

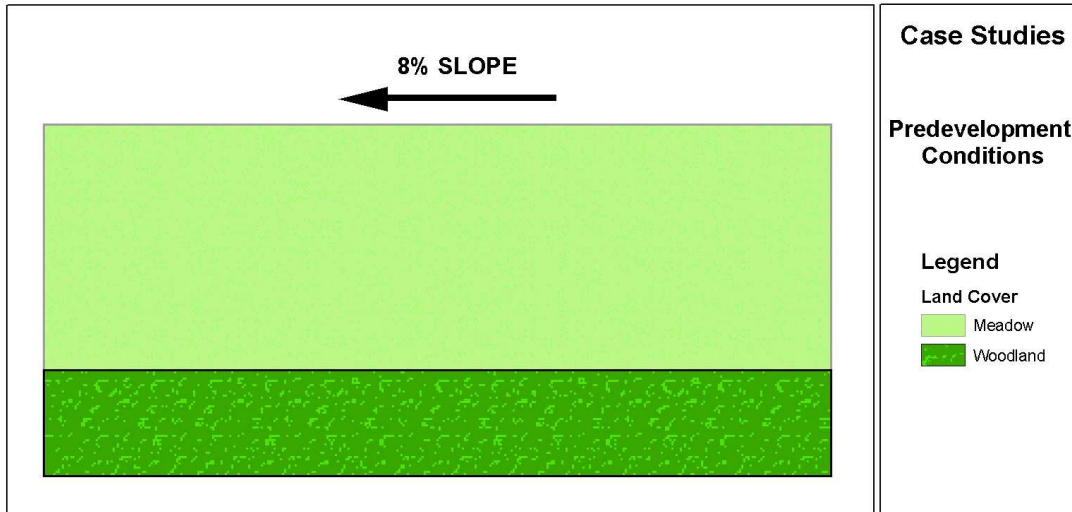
In this example, the same 10-lot residential subdivision is evaluated, but the design has been revised to incorporate Non-structural BMPs. These non-Structural BMPs include:

- Maintaining the existing 3 acres of woods (BMP 5.4.1, Protect Sensitive/Special Value Features and BMP 5.6.1, Minimize Total Disturbed Area). This has the effect of reducing the volume and rate of runoff that must be managed. ***Because this area remains undisturbed, there is no requirement to manage the volume of runoff. The total area considered in Worksheet 4 is reduced from 10 acres to 7 acres.***
- Reducing the amount of cleared and disturbed area in the construction of the homes (BMP 5.6.2, Minimize Soil compaction). Rather than clearing and grading the entire site, approximately one-half of the proposed lawn area on the lots will not be graded and stripped of topsoil. This area will be protected from heavy equipment movement during construction, but much of this area will be converted into lawn as part of the development. A portion of the site (approximately ½ an acre) will be planted in meadow mix (BMP 5.6.3, Re-vegetate Using Native Species). Protecting these areas from grading and compaction during construction maintains their ability to both absorb rainfall and slow the rate of flow across the site. ***To encourage this practice, a “volume credit” is given under BMP 5.6.2. This reduces the volume of runoff to be managed in structural BMPs.***
- Shortening the house setbacks and driveway lengths reduces the amount of impervious cover (BMP 5.5.1, Cluster) as does reducing the street width (BMP 5.7.1 Reduce Street Imperviousness). ***The benefit of BMPs 5.5.1 and 5.7.2 is significant – the amount of impervious area is reduced from 2 acres to 1.6 acres, and the total site imperviousness is reduced from 20% to 16%.***

Rooftop leaders will also be disconnected, but because the disconnected roof leaders will discharge into the Rain Gardens and Infiltration Trenches, the 75-foot overland flow requirement will not be met, and so no additional volume reduction credit is given. Existing trees will also be protected, but because this area is addressed under BMP 5.6.1 (Minimize Total Disturbed Area) additional credit for protecting trees is not given. In other words, credit for a measure (structural or non-structural) can only be taken once.

Following the same Design and Calculation Process for the design with Non-Structural BMPs is as follows:

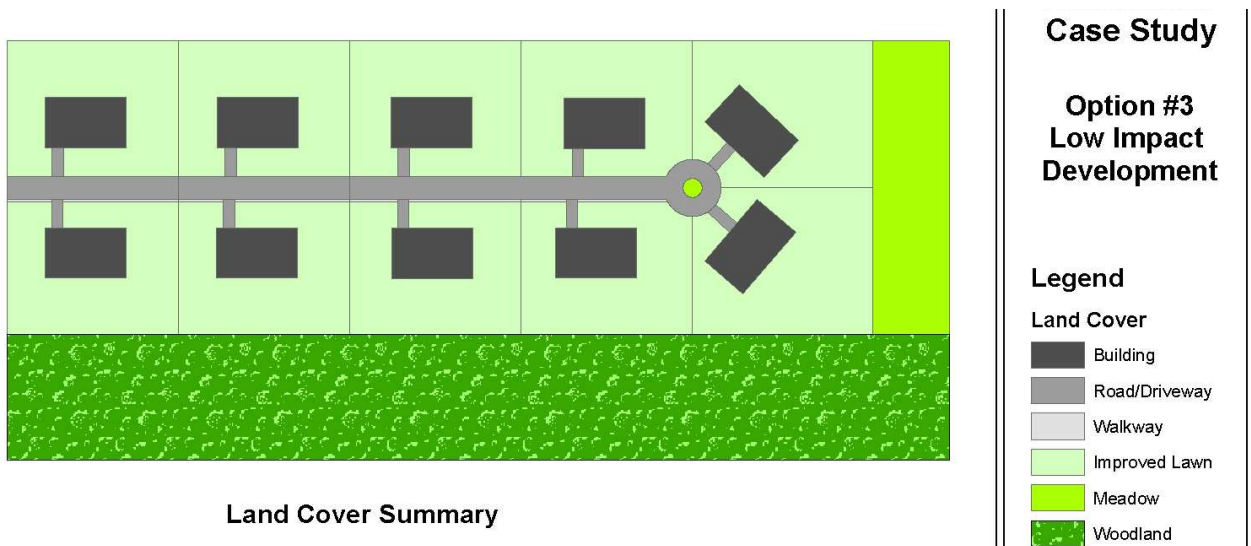
- **Step 1:** Provide General Site Information (Worksheet 1). The Existing Site conditions are the same.



- **Step 2:** Identify sensitive natural resources (if applicable) and what areas will be protected or maintained. (Worksheet 2).

**Note:** In this example, there are 3 acres of woodlands that ARE protected. Therefore, the overall site area contributing to runoff volume requirements is reduced from 10 acres to 7 acres.

- **Step 3:** Estimate the benefits of Non-structural BMPs in the stormwater design (Worksheet 3).



Land Cover Summary

**In this example, Woods are maintained, lot setbacks and driveway lengths are reduced, the street width is reduced, and areas of lawn are protected from topsoil**

**removal and compaction. Portions of lawn are replaced with meadow. Rain Gardens and Infiltration Trenches are placed on each lot, however, these BMPs are reduced in size. The proposed development still includes 10 residential lots.**

**Note: Direct volume credit can be calculated for certain Non-Structural BMPs. In this example, a volume credit of approximately 2,900 ft<sup>3</sup> is provided by creating lawns and meadows in areas that have NOT been cleared of topsoil and have been protected from compaction during construction.**

- **Step 4:** Based on the proposed design, estimate the increased volume of runoff for the 2-Year storm event, using the Cover Complex Curve Number method. **Using a weighted curve number is NOT acceptable.** Runoff volume should be calculated based on major land use types and soil types (Worksheet 4).

**Note: Because a number of Non-structural BMPs are applied (as discussed above), the stormwater management volume requirement is reduced from 25,913 ft<sup>3</sup> to 18,088 ft<sup>3</sup>. This is a 30% reduction in the volume requirement.**

- **Step 5:** Design and incorporate Structural and Non-Structural BMPs that provide volume control for the 2-Year volume increase (Worksheet 5).

Calculations are provided to demonstrate that the required volume is provided. The storage volume is calculated for each rain garden and infiltration trench. The total volume is indicated on Worksheet 5 and compared to the volume requirement for CG1 of the net increase in runoff volume for the 2-year storm (Worksheet 4).

For this example that includes Non-Structural BMPs, the volume requirement has been reduced and so the Structural BMPs are reduced in size. The volume requirement for the original design (without Non-structural BMPs) was 25,913 ft<sup>3</sup>. By incorporating the Non-structural BMPs, this volume requirement has been reduced to 15,199 ft<sup>3</sup> (including the non-structural volume credits). Correspondingly, the structural BMPs have been reduced in size: the rain gardens are reduced from 1,820 ft<sup>2</sup> to 1,070 ft<sup>2</sup> each, and the infiltration trenches are reduced from 1,500 ft<sup>2</sup> to 875 ft<sup>2</sup>.

**Part 1 – Structural BMP Design**

<b>Worksheet 1. General Site Information</b>	
<b>INSTRUCTIONS:</b> Fill out Worksheet 1 for each watershed	
<b>Date:</b>	_____
<b>Project Name:</b>	<u>10 Lot Residential Subdivision</u>
<b>Municipality:</b>	<u>Smith Township</u>
<b>County:</b>	<u>Blair County</u>
<b>Total Area (acres):</b>	<u>10</u>
<b>Major River Basin:</b>	_____
	<a href="http://www.dep.state.pa.us/dep/deputate/watermgt/wc/default.htm#newtopics">http://www.dep.state.pa.us/dep/deputate/watermgt/wc/default.htm#newtopics</a>
<b>Watershed:</b>	<u>Purdy Creek</u>
<b>Sub-Basin:</b>	_____
<b>Nearest Surface Water(s) to Receive Runoff:</b>	<u>Tributary to Purdy Creek</u>
<b>Chapter 93 - Designated Water Use:</b>	<u>HQ</u>
	<a href="http://www.pacode.com/secure/data/025/chapter93/chap93toc.html">http://www.pacode.com/secure/data/025/chapter93/chap93toc.html</a>
<b>Impaired according to Chapter 303(d) List?</b>	Yes <input type="checkbox"/>
	No <input checked="" type="checkbox"/>
<b>List Causes of Impairment:</b>	
<i>Is project subject to, or part of:</i>	
<b>Municipal Separate Storm Sewer System (MS4) Requirements?</b>	Yes <input type="checkbox"/>
	No <input checked="" type="checkbox"/>
<b>Existing or planned drinking water supply?</b>	Yes <input type="checkbox"/>
	No <input checked="" type="checkbox"/>
<b>If yes, distance from proposed discharge (miles):</b>	_____
<b>Approved Act 167 Plan?</b>	Yes <input type="checkbox"/>
	No <input checked="" type="checkbox"/>
	<a href="http://www.dep.state.pa.us/dep/deputate/watermgt/wc/Subjects/StormwaterManagement/GeneralPermits/default.htm">http://www.dep.state.pa.us/dep/deputate/watermgt/wc/Subjects/StormwaterManagement/GeneralPermits/default.htm</a>
<b>Existing River Conservation Plan?</b>	Yes <input type="checkbox"/>
	No <input checked="" type="checkbox"/>
	<a href="http://www.dcnr.state.pa.us/brc/rivers/riversconservation/planningprojects/">http://www.dcnr.state.pa.us/brc/rivers/riversconservation/planningprojects/</a>

**Worksheet 2. Sensitive Natural Resources**

**INSTRUCTIONS:**

1. Provide Sensitive Resources Map according to non-structural BMP 1.1 in Section 5.0 Non-Structural BMPs. This map should identify waterbodies, floodplains, riparian areas, wetlands, woodlands, natural drainage ways, steep slopes, and other sensitive natural features.

2. Summarize the existing extent of each sensitive resource in the Existing Sensitive Resources Table (below, using Acres).

3. Summarize Total Protected Area as defined under BMPs in Section 5.0.

4. Do not count any area twice. For example, an area that is both a floodplain and a wetland may only be considered once.

<b>EXISTING NATURAL SENSITIVE RESOURCE</b>	<b>MAPPED? yes/no/n/a</b>	<b>TOTAL AREA (Ac.)</b>	<b>PROTECTED AREA (Ac.)</b>
Waterbodies			
Floodplains			
Riparian Areas			
Wetlands			
Woodlands	YES	3	0
Natural Drainage Ways			
Steep Slopes, 15% - 25%			
Steep Slopes, over 25%			
Other:			
Other:			
<b>TOTAL EXISTING:</b>		3	0



Worksheet 3. Nonstructural BMP Credits																
<b>PROTECTED AREA</b>																
5.1 Area of Protected Sensitive/Special Value Features (see WS 2)	0 Ac.															
5.2 Area of Riparian Forest Buffer Protection	0 Ac.															
5.6 Area of Minimum Disturbance/Reduced Grading	0 Ac.															
<b>TOTAL</b>	<b>0 Ac.</b>															
<table border="1" style="margin: auto; border-collapse: collapse;"> <tr> <td style="padding: 5px;">Site Area</td> <td style="padding: 5px;"><i>minus</i></td> <td style="padding: 5px;">Protected Area</td> <td style="padding: 5px;">=</td> <td style="padding: 5px;">Stormwater Management Area</td> </tr> <tr> <td style="text-align: center; padding: 5px;"><b>10</b></td> <td style="padding: 5px;">-</td> <td style="text-align: center; padding: 5px;"><b>0</b></td> <td style="padding: 5px;">=</td> <td style="text-align: center; padding: 5px;"><b>10</b></td> </tr> <tr> <td colspan="5" style="text-align: center; padding: 5px;"><i>This is the area that requires stormwater management</i></td> </tr> </table>		Site Area	<i>minus</i>	Protected Area	=	Stormwater Management Area	<b>10</b>	-	<b>0</b>	=	<b>10</b>	<i>This is the area that requires stormwater management</i>				
Site Area	<i>minus</i>	Protected Area	=	Stormwater Management Area												
<b>10</b>	-	<b>0</b>	=	<b>10</b>												
<i>This is the area that requires stormwater management</i>																
<b>VOLUME CREDITS</b>																
<b>5.3 Protect/Utilize Natural Flow Paths</b>																
Flow Path/Depression _____ ft <sup>2</sup>	_____ ft <sup>3</sup>															
x 1/4" x 1/12 =																
<b>5.7 Minimum Soil Compaction</b>																
Lawn _____ ft <sup>2</sup>	_____ ft <sup>3</sup>															
x 1/4" x 1/12 =																
Meadow _____ ft <sup>2</sup>	_____ ft <sup>3</sup>															
x 1/3" x 1/12 =																
<b>3.3 Protect Existing Trees</b>																
<i>For Trees within 100 feet of impervious area:</i>																
Tree Canopy _____ ft <sup>2</sup>	_____ ft <sup>3</sup>															
x 1/2" x 1/12 =																
<i>For Trees within 20 feet of impervious area:</i>																
Tree Canopy _____ ft <sup>2</sup>	_____ ft <sup>3</sup>															
x 1" x 1/12 =																
<b>5.1 Disconnect Roof Leaders to Vegetated Areas</b>																
<i>For Runoff directed to areas protected under 3.1 and 3.2</i>																
Roof Area _____ ft <sup>2</sup>	_____ ft <sup>3</sup>															
x 1/3" x 1/12 =																
<i>For all other disconnected roof areas</i>																
Roof Area _____ ft <sup>2</sup>	_____ ft <sup>3</sup>															
x 1/4" x 1/12 =																
<b>5.2 Disconnect Non-Roof impervious to Vegetated Areas</b>																
<i>For Runoff directed to areas protected under 3.1 and 3.2</i>																
Impervious Area _____ ft <sup>2</sup>	_____ ft <sup>3</sup>															
x 1/3" x 1/12 =																
<i>For all other disconnected roof areas</i>																
Impervious Area _____ ft <sup>2</sup>	_____ ft <sup>3</sup>															
x 1/4" x 1/12 =																
<table border="1" style="margin: auto; border-collapse: collapse;"> <tr> <td style="padding: 5px;"><b>TOTAL NON-STRUCTURAL VOLUME CREDIT*</b></td> <td style="padding: 5px;"><b>0</b></td> <td style="padding: 5px;">ft<sup>3</sup></td> </tr> </table>		<b>TOTAL NON-STRUCTURAL VOLUME CREDIT*</b>	<b>0</b>	ft <sup>3</sup>												
<b>TOTAL NON-STRUCTURAL VOLUME CREDIT*</b>	<b>0</b>	ft <sup>3</sup>														
<small>* For use on Worksheet 5</small>																

**WORKSHEET 4 . CHANGE IN RUNOFF VOLUME FOR 2-YR STORM EVENT**

**PROJECT:** 10 Lot Subdivision  
**Drainage Area:** 1 (acres)  
**2-Year Rainfall:** 2.8 in

**Total Site Area:** 10 acres  
**Protected Site Area:** 0 acres  
**Stormwater Management Area:** 10 acres (From Worksheet 3)

**Existing Conditions:**

Cover Type	Soil Type	Area (sf)	Area (ac)	CN	S	Q Runoff <sup>1</sup> (in)	Runoff Volume <sup>2</sup> (ft <sup>3</sup> )
Woodland	C	130,680	3.0	70	4.29	0.61	6,600
Meadow	C	304,920	7.0	71	4.08	0.65	16,469
Impervious	C	-	0.0				
<b>TOTAL:</b>			<b>10</b>				<b>23,069</b>

**Developed Conditions:**

Cover Type	Soil Type	Area (sf)	Area (ac)	CN	S	Q Runoff <sup>1</sup> (in)	Runoff Volume <sup>2</sup> (ft <sup>3</sup> )
Buildings	C	45050	1.0	98	0.20	2.57	9,645
Roads, Driveways, walks	C	42070	1.0	98	0.20	2.57	9,007
Lawn	C	333480	7.7	79	2.66	1.04	29,024
Detention Basin	C	15,000	0.3	79	2.66	1.04	1,306
<b>TOTAL:</b>			<b>10</b>				<b>48,982</b>

**2-Year Volume Increase (ft<sup>3</sup>):** 25,913

**2-Year Volume Increase = Developed Conditions Runoff Volume - Existing Conditions Runoff Volume**  
 = 48,982 - 23,069 = 25, 913 ft<sup>3</sup>

1. Runoff (in) =  $Q = (P - 0.2S)^2 / (P + 0.8S)$  where

P = 2-Year Rainfall (in)

s =  $(1000/CN) - 10$

2. Runoff Volume (CF) =  $Q \times \text{Area} \times 1/12 \times 43,560 \text{ ft}^2/\text{acre}$

Q = Runoff (in)

Area = Stormwater Management Area (ac) from Worksheet 3

**Note:** Runoff Volume must be calculated for EACH land use type and soil. The use of a weighted CN value for volume calculations is not acceptable.

**WORKSHEET 5 . STRUCTURAL BMP VOLUME CREDITS**

**PROJECT:** 10 Lot Subdivision

**SUB-BASIN:** 1

Required Control Volume (ft<sup>3</sup>) - from Worksheet 4: 25,913  
 Non-structural Volume Credit (ft<sup>3</sup>) - from Worksheet 3: - 0

Structural Volume Reqmt (ft<sup>3</sup>) 25,913  
 (Required Control Volume minus Non-structural Credit)

Proposed BMP*	Area (ft <sup>2</sup> )	Storage Volume (ft <sup>3</sup> )
6.4.1 Porous Pavement		
6.4.2 Infiltration Basin		
6.4.3 Infiltration Bed		
6.4.4 Infiltration Trench	10	6,000
6.4.5 Rain Garden/Bioretenion	10	20,020
6.4.6 Dry Well / Seepage Pit		
6.4.7 Constructed Filter		
6.4.8 Vegetated Swale		
6.4.9 Vegetated Filter Strip		
6.4.10 Berm		
6.5.1 Vegetated Roof		
6.5.2 Capture and Re-use		
6.6.1 Constructed Wetlands		
6.6.2 Wet Pond / Retention Basin		
6.6.3 Dry Extended Detention Basin		
6.6.4 Water Quality Filters		
6.7.1 Riparian Buffer Restoration		
6.7.2 Landscape Restoration / Reforestation		
6.7.3 Soil Amendment		
6.8.1 Level Spreader		
6.8.2 Special Storage Areas		
<i>Other</i>		26,020

Total Structural Volume (ft<sup>3</sup>): 26,020  
 Structural Volume Requirement (ft<sup>3</sup>): 25,913

DIFFERENCE 107

\* Complete BMP Design Checklist for each measure proposed  
 Note: provide supporting Volume Calculations for each Structural BMP

**Supporting Calculations for Worksheet 5: Part 1 Structural BMPs**

**Design Volume Calculations for Structural, Volume-Reduction BMPs**

**1. Infiltration Trenches:**

$$\begin{aligned}
 \text{Storage Volume} &= \text{Area} \times \text{Depth to overflow} \times \text{Void Space in Stone} \\
 &= 1,500 \text{ ft}^2 \times 1.0 \text{ ft} \times 40\% \\
 &= \mathbf{600 \text{ ft}^3}
 \end{aligned}$$

Infiltration Volume for “Volume Abstraction” in Routing Process:

$$\begin{aligned}
 &= \text{Infiltration Rate} \times \text{Infiltration Area} \times \text{Infiltration Period (assume 6 hours)} \\
 &= 1/2 \text{ in/hour} \times 1,500 \text{ ft}^2 \times 6 \text{ hr} \times (1/12) \text{ ft/in} \\
 &= 375 \text{ ft}^3
 \end{aligned}$$

$$\begin{aligned}
 \text{Total “Volume Abstraction”} &= \text{Storage Volume} + \text{Infiltration Volume} \\
 &= 600 \text{ ft}^3 + 375 \text{ ft}^3 = \mathbf{975 \text{ ft}^3}
 \end{aligned}$$

**2. Rain Gardens**

$$\begin{aligned}
 \text{Storage Volume} &= \text{Surface Storage} + \text{Soil Storage}^* \\
 &= (\text{Area} \times \text{Depth}) + (\text{Area} \times \text{Soil Depth} \times 10\%) \\
 &= (1,820 \text{ ft}^2 \times 1.0 \text{ ft}) + (1,820 \text{ ft}^2 \times 1 \text{ ft} \times 10\%) \\
 &= \mathbf{2,002 \text{ ft}^3}
 \end{aligned}$$

Infiltration Volume for “Volume Abstraction” in Routing Process:

$$\begin{aligned}
 &= \text{Infiltration Rate} \times \text{Infiltration Area} \times \text{Infiltration Period (assume 6 hours)} \\
 &= 1/2 \text{ in/hour} \times 1,820 \text{ ft}^2 \times 6 \text{ hr} \times (1/12) \text{ ft/in} \\
 &= 455 \text{ ft}^3
 \end{aligned}$$

$$\begin{aligned}
 \text{Total “Volume Abstraction”} &= \text{Storage Volume} + \text{Infiltration Volume} \\
 &= 2,002 \text{ ft}^3 + 455 \text{ ft}^3 = \mathbf{2,457 \text{ ft}^3}
 \end{aligned}$$

Structural Volume Storage per Lot = Infiltration Trench + Rain Garden = 2,602 ft<sup>3</sup>

*\* Assume 1 ft depth modified soil with 10% void space for water retention.*

## WORKSHEET 6 . SMALL SITE / SMALL IMPERVIOUS AREA EXCEPTION FOR PEAK RATE MITIGATION CALCULATIONS

*The following conditions must be met for exemption from peak rate analysis for small sites under CG-1:*

Yes The 2-Year Runoff Volume increase must be met in BMPs designed in accordance with Manual Standards

No Total Site Impervious Area may not exceed **1 acre**.

Yes Maximum Development Area is **10 acres**.

Yes Maximum site impervious cover cannot be greater than 50%.

Yes No more than 25% Volume Control can be in Non-structural BMPs

Yes Infiltration BMPs must have an infiltration rate of 0.5 in/hr.

Site Area	Percent Impervious	Total Impervious
10 acre	10%	1 acre
5 acre	20%	1 acre
2 acre	50%	1 acre
1 acre	50%	0.5 acre
0.5 acre	50%	0.25 acre

**Peak Rate Calculations for Structural BMP Case**

As discussed previously, the residential subdivision was modeled for peak rate mitigation using two techniques: Composite BMP and Travel Time Adjustment with Volume Diversion. As a comparison, dry detention basins were also simulated for conventional peak rate control as well as for extended detention. The properties of the infiltration trenches and rain gardens as shown in tables D-1 and D-2.

**Table D-1. Properties of Infiltration Trenches**

Stage (ft)	Area (SF)	Individual Storage (AF)	Total Storage (AF)	Individual Discharge (cfs)	Total Discharge (cfs)	Individual Infiltration (cfs)	Total Infiltration (cfs)
0.00	1,500	0.000	0.000	0.00	0.00	0.00	0.00
0.01	1,500	0.000	0.001	0.02	0.17	0.02	0.17
0.1	1,500	0.001	0.014	0.02	0.17	0.02	0.17
0.2	1,500	0.003	0.028	0.02	0.17	0.02	0.17
0.3	1,500	0.004	0.041	0.02	0.17	0.02	0.17
0.4	1,500	0.006	0.055	0.02	0.17	0.02	0.17
0.5	1,500	0.007	0.069	0.02	0.17	0.02	0.17
0.6	1,500	0.008	0.083	0.02	0.17	0.02	0.17
0.7	1,500	0.010	0.096	0.02	0.17	0.02	0.17
0.8	1,500	0.011	0.110	0.25	2.54	0.02	0.17
0.9	1,500	0.012	0.124	0.69	6.88	0.02	0.17
1	1,500	0.014	0.138	1.25	12.49	0.02	0.17

**Table D-2. Properties of Rain Gardens**

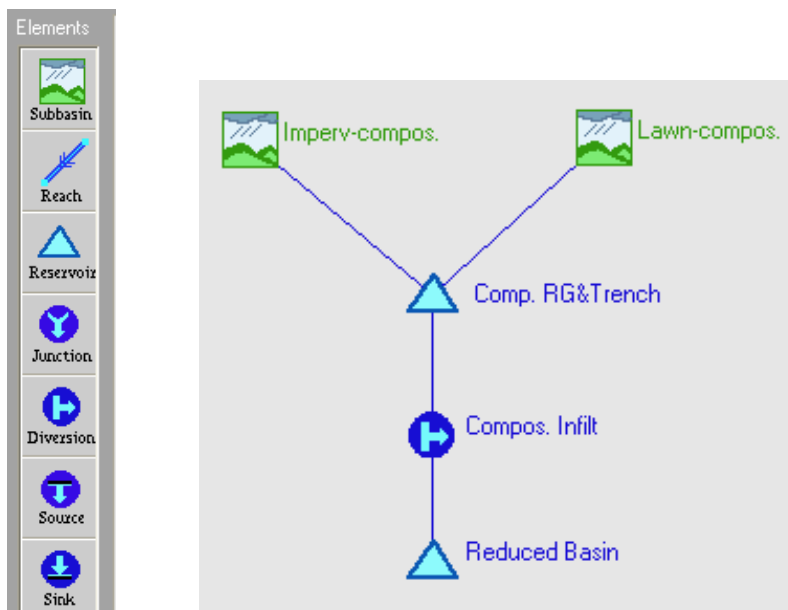
Stage (ft)	Area (SF)	Individual Storage (AF)	Total Storage (AF)	Individual Discharge (cfs)	Total Discharge (cfs)	Individual Infiltration (cfs)	Total Infiltration (cfs)
0.00	1,820	0.000	0.000	0.00	0.00	0.00	0.00
0.01	1,820	0.005	0.046	0.02	0.21	0.02	0.21
0.1	1,820	0.008	0.084	0.02	0.21	0.02	0.21
0.2	1,820	0.013	0.125	0.02	0.21	0.02	0.21
0.3	1,820	0.017	0.167	0.02	0.21	0.02	0.21
0.4	1,820	0.021	0.209	0.02	0.21	0.02	0.21
0.5	1,820	0.025	0.251	0.02	0.21	0.02	0.21
0.6	1,820	0.029	0.292	0.38	3.81	0.02	0.21
0.7	1,820	0.033	0.334	1.02	10.21	0.02	0.21
0.8	1,820	0.038	0.376	1.78	17.81	0.02	0.21
0.9	1,820	0.042	0.418	2.74	27.41	0.02	0.21
1	1,820	0.046	0.460	3.06	30.61	0.02	0.21

For the Composite BMP method, the infiltration trenches and rain gardens are summed into a single combined storage reservoir for modeling purposes. The properties of the “Composite BMP” are given in Table D-3.

**Table D-3.** Properties of Composite Infiltration Trench/Rain Garden

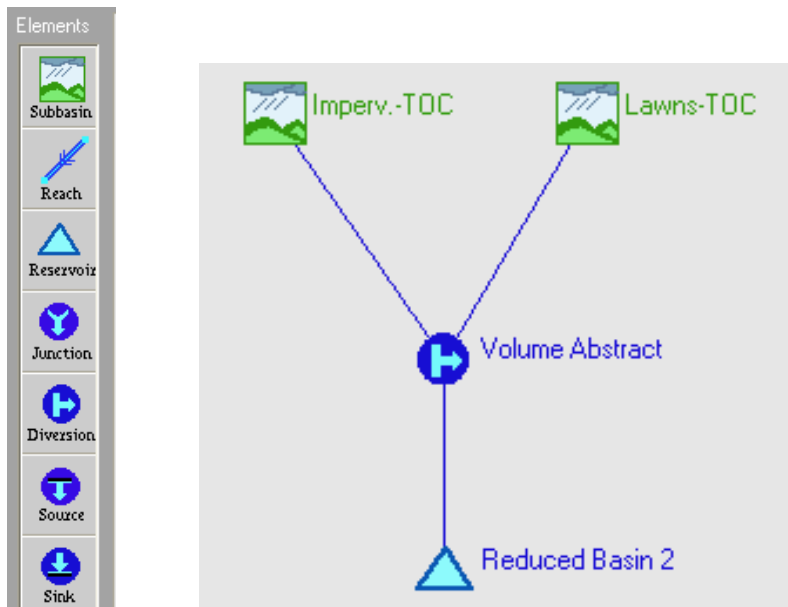
Stage (ft)	Total Storage (AF)	Total Discharge (cfs)	Total Infiltration (cfs)
0.00	0.000	0.00	0.00
0.01	0.047	0.38	0.38
0.1	0.097	0.38	0.38
0.2	0.153	0.38	0.38
0.3	0.208	0.38	0.38
0.4	0.264	0.38	0.38
0.5	0.320	0.38	0.38
0.6	0.375	3.98	0.38
0.7	0.431	10.38	0.38
0.8	0.486	20.35	0.38
0.9	0.542	34.29	0.38
1	0.597	43.10	0.38

All scenarios were modeled using the U.S. Army Corp of Engineers' Hydrologic Modeling System (HEC-HMS) Version 2.2.2 (May 28, 2003). The model schematic for the Composite BMP method is shown in Figure D-1. Notice that the impervious and pervious areas are routed separately to the Composite Storage Reservoir ("Comp. RG&Trench") and then the runoff being infiltrated is removed through a Composite Infiltration Rate ("Compos. Infiltr") based on the design infiltration rate of the BMPs.

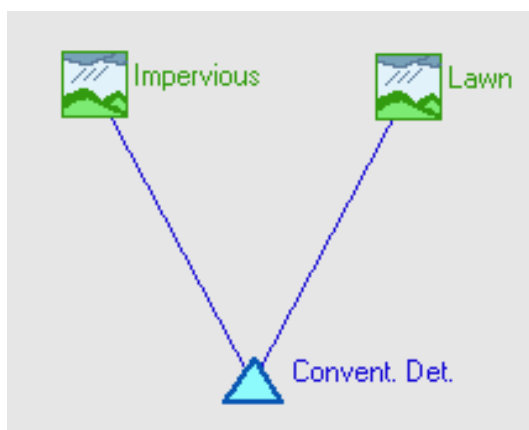


**Figure D-1.** Model Schematic for Composite BMP

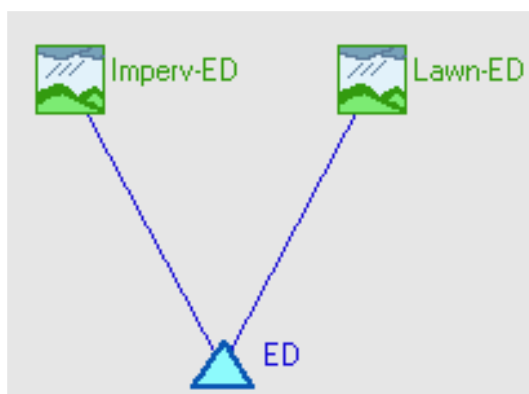
The model schematic for 'Travel Time Adjustment with Volume Diversion' method is shown in Figure D-2. Figures D-3 and D-4 shown the model setups for conventional peak rate control and extended detention respectively.



**Figure D-2.** Model Schematic for 'Travel Time Adjustment with Volume Diversion' method



**Figure D-3.** Model Schematic for conventional peak rate control



**Figure D-4.** Model Schematic for extended detention



In the ‘Travel Time Adjustment with Volume Diversion’ method the Time of Concentration was increased by the average residence time of the volume-reducing BMPs that were not be routed. The residence time for the 100-year storm was used to be conservative. The residence time is simply calculated by dividing the storage volume of the BMPs by the unmitigated post-development 100-year peak flow. As shown in Table D-4, this results in an average residence time of 9.1 minutes. The post-development time of concentration was increased by this amount in the model to account for the slowing effect of the volume-reduction BMPs.

**Table D-4.** Time of Concentration Adjustment

Storm Event	Peak Flow without BMPs (cfs)	Volume Control BMP Storage (CF)	Ave. Residence Time/ Time of Conc. Increase (min.)
100	47.5	26,020	9.1

In addition to increasing the time of concentration, the volume-reduction BMPs will also significantly reduce the amount of runoff being discharged by the site. In order to account for this in the ‘Travel Time Adjustment with Volume Diversion’ method and “volume abstraction” is incorporated into the model. The runoff simulated in the model is abstracted or “diverted” until the storage and infiltration volume of the BMPs is full. After that point, the diversion has no effect on the runoff rate or volume. The total volume abstracted in the model is calculated in Table D-5.

**Table D-5.** Total Volume Abstraction from Infiltration Trenches and Rain Gardens

BMP Type	Total Bottom Area (SF)	Design Infiltration Rate (in./hr)	Applied Infiltration Period Prior to Peak Runoff (hr)	Infiltration Volume (CF)	Storage Volume (CF)	Total Volume Abstraction (CF)
Infiltr. Trench	15,000	0.5	6	3,750	6,000	9,750
Rain Garden	18,200	0.5	6	4,550	20,020	24,570
<b>TOTAL</b>	33,200	---	---	8,300	26,020	<b>34,320</b>

The results for the various scenarios are shown in Table D-6. Important results to note include:

- **The drastic increase in runoff for both cases without volume-reduction BMPs**
- **The volume control provided by infiltration BMPs, even for the 10- and 100-year storms**
- **The reduced downstream extended detention requirements when using infiltration BMPs:**
  - **Reduced from 45,000 to 25,000 for the “Composite BMP” method**
  - **Reduced from 45,000 to 16,000 for the “Travel Time Adjustment with Volume Diversion” method**
- **The improved peak rate control with volume-reduction BMPs**

**Table D-6.** Modeling Results for all scenarios

**Runoff Volume Results**

Storm Event	Pre-Dev. Runoff (in.)	Conv. Basin (40,000 CF)		Infilt. BMPs (26,000 CF)	
		Post-Dev. Runoff (in.)	Change (%)	Post-Dev. Runoff (in.)	Change (%)
1	0.43	1.09	153%	0.23	-47%
2	0.64	1.39	117%	0.47	-27%
10	1.57	2.62	67%	1.58	1%
100	2.71	3.96	46%	2.86	6%

**Peak Rate for Detention - 40,000 CF Conventional Basin & 45,000 CF E.D. Basin\***

Storm Event	Pre-Dev. Peak (cfs)	Post-Dev. Peak (cfs)	Conventional Basin		Extended Det. Basin	
			Post-Dev. Peak w/ Basin (cfs)	Change (%)	Post-Dev. Peak w/ ED (cfs)	Change (%)
1	3.9	12.2	3.0	-23.1%	1.14	-62.0%
2	6.3	16.0	5.0	-20.6%	2.6	-48.0%
10	17.6	31.2	15.4	-12.6%	14.2	-7.8%
100	30.9	47.5	29.9	-3.2%	29.2	-2.3%

\* Extended detention flow target for 1-year storm is 1.15 cfs from WS 9

**Peak Rate for Volume Control Approaches (Trenches/RGs & Reduced Detention)**

Storm Event	Pre-Dev. Peak (cfs)	Post-Dev. Peak (cfs)	Composite Volume BMPs & 25,000 Det.		TOC Adj./ Vol. Abstract. & 16,000 CF Det.	
			Post-Dev. Peak w/ Volume Control (cfs)	Change (%)	Post-Dev. Peak w/ Volume Control (cfs)	Change (%)
1	3.9	12.2	1.2	-69.2%	0.22	-81.7%
2	6.3	16.0	3.0	-52.4%	0.7	-78.3%
10	17.6	31.2	14.9	-15.5%	11.8	-20.8%
100	30.9	47.5	30.8	-0.3%	30.4	-1.3%

**Part 2 – Structural and Non-structural BMP Design**

Worksheet 1. General Site Information	
<b>INSTRUCTIONS:</b> Fill out Worksheet 1 for each watershed	
<b>Date:</b>	_____
<b>Project Name:</b>	<u>10 Lot Residential Subdivision</u>
<b>Municipality:</b>	<u>Smith Township</u>
<b>County:</b>	<u>Blair County</u>
<b>Total Area (acres):</b>	<u>10</u>
<b>Major River Basin:</b>	_____
	<a href="http://www.dep.state.pa.us/dep/deputate/watermgt/wc/default.htm#newtopics">http://www.dep.state.pa.us/dep/deputate/watermgt/wc/default.htm#newtopics</a>
<b>Watershed:</b>	<u>Purdy Creek</u>
<b>Sub-Basin:</b>	_____
<b>Nearest Surface Water(s) to Receive Runoff:</b>	<u>Tributary to Purdy Creek</u>
<b>Chapter 93 - Designated Water Use:</b>	<u>HQ</u>
	<a href="http://www.pacode.com/secure/data/025/chapter93/chap93toc.html">http://www.pacode.com/secure/data/025/chapter93/chap93toc.html</a>
<b>Impaired according to Chapter 303(d) List?</b>	Yes <input type="checkbox"/>
	No <input checked="" type="checkbox"/>
<b>List Causes of Impairment:</b>	
<i>Is project subject to, or part of:</i>	
<b>Municipal Separate Storm Sewer System (MS4) Requirements?</b>	Yes <input type="checkbox"/>
	No <input checked="" type="checkbox"/>
<b>Existing or planned drinking water supply?</b>	Yes <input type="checkbox"/>
	No <input checked="" type="checkbox"/>
<b>If yes, distance from proposed discharge (miles):</b>	_____
<b>Approved Act 167 Plan?</b>	Yes <input type="checkbox"/>
	No <input checked="" type="checkbox"/>
	<a href="http://www.dep.state.pa.us/dep/deputate/watermgt/wc/Subjects/StormwaterManagement/GeneralPermits/default.htm">http://www.dep.state.pa.us/dep/deputate/watermgt/wc/Subjects/StormwaterManagement/GeneralPermits/default.htm</a>
<b>Existing River Conservation Plan?</b>	Yes <input type="checkbox"/>
	No <input checked="" type="checkbox"/>
	<a href="http://www.dcnr.state.pa.us/brc/rivers/riversconservation/planningprojects/">http://www.dcnr.state.pa.us/brc/rivers/riversconservation/planningprojects/</a>

**Worksheet 2. Sensitive Natural Resources**

**INSTRUCTIONS:**

1. Provide Sensitive Resources Map according to non-structural BMP 1.1 in Section 5.0 Non-Structural BMPs. This map should identify waterbodies, floodplains, riparian areas, wetlands, woodlands, natural drainage ways, steep slopes, and other sensitive natural features.

2. Summarize the existing extent of each sensitive resource in the Existing Sensitive Resources Table (below, using Acres).

3. Summarize Total Protected Area as defined under BMPs in Section 5.0.

4. Do not count any area twice. For example, an area that is both a floodplain and a wetland may only be considered once.

<b>EXISTING NATURAL SENSITIVE RESOURCE</b>	<b>MAPPED? yes/no/n/a</b>	<b>TOTAL AREA (Ac.)</b>	<b>PROTECTED AREA (Ac.)</b>
Waterbodies			
Floodplains			
Riparian Areas			
Wetlands			
Woodlands	YES	3	3
Natural Drainage Ways			
Steep Slopes, 15% - 25%			
Steep Slopes, over 25%			
Other:			
Other:			
<b>TOTAL EXISTING:</b>		3	3

Worksheet 3. Nonstructural BMP Credits																
<b>PROTECTED AREA</b>																
5.1 Area of Protected Sensitive/Special Value Features (see WS 2)	<u>  0  </u> Ac.															
5.2 Area of Riparian Forest Buffer Protection	<u>  0  </u> Ac.															
5.6 Area of Minimum Disturbance/Reduced Grading	<u>  3  </u> Ac.															
<b>TOTAL</b>	<b><u>  3  </u> Ac.</b>															
<table border="1" style="margin: auto; border-collapse: collapse;"> <tr> <td style="padding: 5px;">Site Area</td> <td style="padding: 5px;"><i>minus</i></td> <td style="padding: 5px;">Protected Area</td> <td style="padding: 5px;">=</td> <td style="padding: 5px;">Stormwater Management Area</td> </tr> <tr> <td style="text-align: center; padding: 5px;"><u>  10  </u></td> <td style="padding: 5px;">-</td> <td style="text-align: center; padding: 5px;"><u>  3  </u></td> <td style="padding: 5px;">=</td> <td style="text-align: center; padding: 5px;"><u>  7  </u></td> </tr> <tr> <td colspan="5" style="text-align: center; padding: 5px;"><i>This is the area that requires stormwater management</i></td> </tr> </table>		Site Area	<i>minus</i>	Protected Area	=	Stormwater Management Area	<u>  10  </u>	-	<u>  3  </u>	=	<u>  7  </u>	<i>This is the area that requires stormwater management</i>				
Site Area	<i>minus</i>	Protected Area	=	Stormwater Management Area												
<u>  10  </u>	-	<u>  3  </u>	=	<u>  7  </u>												
<i>This is the area that requires stormwater management</i>																
<b>VOLUME CREDITS</b>																
<b>5.3 Protect/Utilize Natural Flow Paths</b>																
Flow Path/Depression <u>  NA  </u> ft <sup>2</sup>	x 1/4" x 1/12 = <u>  0  </u> ft <sup>3</sup>															
<b>5.7 Minimum Soil Compaction</b>																
Lawn <u>  105,006  </u> ft <sup>2</sup>	x 1/4" x 1/12 = <u>  2,188  </u> ft <sup>3</sup>															
Meadow <u>  25,240  </u> ft <sup>2</sup>	x 1/3" x 1/12 = <u>  701  </u> ft <sup>3</sup>															
<b>3.3 Protect Existing Trees</b>																
<i>For Trees within 100 feet of impervious area:</i>																
Tree Canopy <u>  NA  </u> ft <sup>2</sup>	x 1/2" x 1/12 = <u>  0  </u> ft <sup>3</sup>															
<i>For Trees within 20 feet of impervious area:</i>																
Tree Canopy <u>  NA  </u> ft <sup>2</sup>	x 1" x 1/12 = <u>  0  </u> ft <sup>3</sup>															
<b>5.1 Disconnect Roof Leaders to Vegetated Areas</b>																
<i>For Runoff directed to areas protected under 3.1 and 3.2</i>																
Roof Area <u>  NA  </u> ft <sup>2</sup>	x 1/3" x 1/12 = <u>  0  </u> ft <sup>3</sup>															
<i>For all other disconnected roof areas</i>																
Roof Area <u>  NA  </u> ft <sup>2</sup>	x 1/4" x 1/12 = <u>  0  </u> ft <sup>3</sup>															
<b>5.2 Disconnect Non-Roof impervious to Vegetated Areas</b>																
<i>For Runoff directed to areas protected under 3.1 and 3.2</i>																
Impervious Area <u>  NA  </u> ft <sup>2</sup>	x 1/3" x 1/12 = <u>  0  </u> ft <sup>3</sup>															
<i>For all other disconnected roof areas</i>																
Impervious Area <u>  NA  </u> ft <sup>2</sup>	x 1/4" x 1/12 = <u>  0  </u> ft <sup>3</sup>															
<b>TOTAL NON-STRUCTURAL VOLUME CREDIT*</b> <u>  2,889  </u> ft <sup>3</sup>																
<small>* For use on Worksheet 5</small>																

**WORKSHEET 4 . CHANGE IN RUNOFF VOLUME FOR 2-YR STORM EVENT**

**PROJECT:** 10 Lot Subdivision  
**Drainage Area:** 1 (acres)  
**2-Year Rainfall:** 2.8 in

**Total Site Area:** 10 acres  
**Protected Site Area:** 3 acres  
**Stormwater Management Area:** 7 acres (From Worksheet 3)

**Existing Conditions:**

Cover Type	Soil Type	Area (sf)	Area (ac)	CN	S	Q Runoff <sup>1</sup> (in)	Runoff Volume <sup>2</sup> (ft <sup>3</sup> )
Woodland Not Included							
Meadow	C	304,920	7.0	71	4.08	0.65	16,469
Impervious	C	-	0.0				
<b>TOTAL:</b>			<b>7</b>				<b>16,469</b>

**Developed Conditions:**

Cover Type	Soil Type	Area (sf)	Area (ac)	CN	S	Q Runoff <sup>1</sup> (in)	Runoff Volume <sup>2</sup> (ft <sup>3</sup> )
Buildings	C	45050	1.0	98	0.20	2.57	9,645
Roads, Driveways, walks	C	24619	0.6	98	0.20	2.57	5,271
Lawn	C	90006	2.1	79	2.66	1.04	7,834
Detention Basin	C	15,000	0.3	79	2.66	1.04	1,306
Lawn with Minimal Comp	C	105,005	2.4	79	2.66	1.04	9,139
Meadow	C	25,240	0.6	71	4.08	0.65	1,363
Woods Not Included	C						
<b>TOTAL:</b>			<b>7</b>				<b>34,557</b>

**2-Year Volume Increase (ft3):** 18,088

**2-Year Volume Increase = Developed Conditions Runoff Volume - Existing Conditions Runoff Volume**  
 = 34,5577 - 16,469 = 18,088 ft3

1. Runoff (in) =  $Q = (P - 0.2S)^2 / (P + 0.8S)$  where

P = 2-Year Rainfall (in)

S =  $(1000/CN) - 10$

2. Runoff Volume (CF) =  $Q \times \text{Area} \times 1/12 \times 43,560 \text{ ft}^2/\text{acre}$

Q = Runoff (in)

Area = Stormwater Management Area (ac) from Worksheet 3

**Note: Runoff Volume must be calculated for EACH land use type and soil. The use of a weighted CN value for volume calculations is not acceptable.**

## WORKSHEET 5 . STRUCTURAL BMP VOLUME CREDITS

**PROJECT:** 10 Lot Subdivision  
**SUB-BASIN:** 1

Required Control Volume (ft <sup>3</sup> ) - <i>from Worksheet 4:</i>		18,088
Non-structural Volume Credit (ft <sup>3</sup> ) - <i>from Worksheet 3:</i>	-	2,889
<b>Structural Volume Reqmt (ft<sup>3</sup>)</b>		<b>15,199</b>
<i>(Required Control Volume minus Non-structural Credit)</i>		

Proposed BMP*	Area (ft <sup>2</sup> )	Storage Volume (ft <sup>3</sup> )
6.4.1 Porous Pavement		
6.4.2 Infiltration Basin		
6.4.3 Infiltration Bed		
6.4.4 Infiltration Trench	10	3,500
6.4.5 Rain Garden/Bioretenion	10	11,770
6.4.6 Dry Well / Seepage Pit		
6.4.7 Constructed Filter		
6.4.8 Vegetated Swale		
6.4.9 Vegetated Filter Strip		
6.4.10 Berm		
6.5.1 Vegetated Roof		
6.5.2 Capture and Re-use		
6.6.1 Constructed Wetlands		
6.6.2 Wet Pond / Retention Basin		
6.6.3 Dry Extended Detention Basin		
6.6.4 Water Quality Filters		
6.7.1 Riparian Buffer Restoration		
6.7.2 Landscape Restoration / Reforestation		
6.7.3 Soil Amendment		
6.8.1 Level Spreader		
6.8.2 Special Storage Areas		
<i>Other</i>		15,270

<b>Total Structural Volume (ft<sup>3</sup>):</b>		15,270
<b>Structural Volume Requirement (ft<sup>3</sup>):</b>		15,199
<b>DIFFERENCE</b>		<b>71</b>

\* Complete BMP Design Checklist for each measure proposed BMP  
 NOTE: Provide supporting Volume Calculations for each Structural BMP

**Supporting Calculations for Worksheet 5: Part 2 – Structural and Non-Structural BMP Design**

**Volume Credits for Structural BMPs**

**1. Infiltration Trench:**

$$\begin{aligned} \text{Storage Volume} &= \text{Area} \times \text{Depth to overflow} \times \text{Void Space in Stone} \\ &= 875 \text{ ft}^2 \times 1.0 \text{ ft} \times 40\% \\ &= \mathbf{350 \text{ ft}^3} \end{aligned}$$

Infiltration Volume for “Volume Abstraction” in Routing Process:

$$\begin{aligned} &= \text{Infiltration Rate} \times \text{Infiltration Area} \times \text{Infiltration Period (assume 6 hours)} \\ &= 1/2 \text{ in/hour} \times 875 \text{ ft}^2 \times 6 \text{ hr} \times (1/12) \text{ ft/in} \\ &= 219 \text{ ft}^3 \end{aligned}$$

$$\begin{aligned} \text{Total “Volume Abstraction”} &= \text{Storage Volume} + \text{Infiltration Volume} \\ &= 350 \text{ ft}^3 + 219 \text{ ft}^3 = \mathbf{569 \text{ ft}^3} \end{aligned}$$

**2. Rain Garden:**

$$\begin{aligned} \text{Storage Volume} &= \text{Surface Storage} + \text{Soil Storage}^* \\ &= (\text{Area} \times \text{Depth to Overflow}) + (\text{Area} \times \text{Soil Depth} \times 10\%) \\ &= (1,070 \text{ ft}^2 \times 1.0 \text{ ft}) + (1,070 \times 1 \text{ ft} \times 10\%) \\ &= \mathbf{1,177 \text{ ft}^3} \end{aligned}$$

Infiltration Volume for “Volume Abstraction” in Routing Process:

$$\begin{aligned} &= \text{Infiltration Rate} \times \text{Infiltration Area} \times \text{Infiltration Period (assume 6 hours)} \\ &= 1/2 \text{ in/hour} \times 1,070 \text{ ft}^2 \times 6 \text{ hr} \times (1/12) \text{ ft/in} \\ &= 268 \text{ ft}^3 \end{aligned}$$

$$\begin{aligned} \text{Total “Volume Abstraction”} &= \text{Storage Volume} + \text{Infiltration Volume} \\ &= 1,177 \text{ ft}^3 + 268 \text{ ft}^3 = \mathbf{1,445 \text{ ft}^3} \end{aligned}$$

Structural Volume Storage per Lot = Infiltration Trench + Rain Garden = 1,527 ft<sup>3</sup>

*\* Assume 1 ft depth modified soil with 10% void space for water retention.*





## GLOSSARY

**alkalinity** - A measure of the capacity of water to neutralize acids because of the presence of one or more of the following bases in the water: carbonates, bicarbonates, hydroxides, borates, silicates, or phosphates.

**ammonia nitrogen (NH<sub>4</sub>-N)** - A reduced form of nitrogen produced as a by-product of organic matter decomposition and synthesized from oxidized nitrogen by biological and physical processes.

**aspect ratio** - Ratio of wetland cell length to width.

**attenuation** - Reduction in magnitude, as in the lowering of peak runoff discharge rates, in the case of dry ponds; or the reduction of contaminant concentrations, as in the action of biodegradation in wetlands or bioretention facilities.

**base flow** - Normally refers to the stream levels associated primarily with groundwater or subsurface contributions, as opposed to storm flow which corresponds to stream levels associated with recent precipitation and surface runoff.

**bedrock** - Layer of consolidated rock over which lies an overburden of soil (regolith), including unconsolidated rock.

**benthic** - Pertaining to occurrence on or in the bottom sediment of wetland and aquatic ecosystems, including wetlands.

**Best Management Practices (BMP)** - Activities, facilities, measures, or procedures used to manage the volume, rate and water quality of stormwater runoff.

**biodiversity** - The number of species of plants and animals in a defined area. Biodiversity is measured by a variety of indices that consider the number of species and, in some cases, the distribution of individuals among species.

**biomass** - The total mass of living tissues (plant and animal).

**biochemical oxygen demand (BOD)** - A measure of the concentration of aerobically degradable compounds in water. Measured as the oxygen consumed during degradation of organic and inorganic materials in water.

**BMP fingerprinting** - A series of techniques for locating BMPs (particularly ponds) within a development site so as to minimize their impacts to wetlands, forest, and sensitive stream reaches.

**BOD<sub>5</sub>** - Five-day biochemical oxygen demand.

**buffer** - A vegetated strip immediately adjacent to a water body. The primary function of buffers is to protect the receiving water from sediment and pollutants derived from upstream areas. Ancillary benefits may include infiltration of rainfall and habitat enhancement. A buffer is a special case of a filter strip. Forested riparian buffers are one example of a best management practice related to the use of buffers.

**channelization** - The creation of a channel or channels resulting in faster water flow, a reduction in hydraulic residence time, and less contact between water and solid surfaces in the water body.

**chemical oxygen demand (COD)** - A measure of the concentration of substances which can be oxidized in water. Expressed as the oxygen equivalent consumed when an aqueous sample is reacted of the organic matter in water, based on reaction with a strong chemical oxidant.

**choker course** - A filter layer of finer material, usually crushed stone, that is installed over a coarse road base material. The purpose of the choker course is to provide a stable foundation for the construction of a pavement.

**critical depth** - The depth of flow at which the specific energy is a minimum for a given discharge rate. Flow is critical when the Froude number is equal to one:

$$F = \frac{V}{\sqrt{gD}}$$

where V, is the velocity of the flow, g, is the gravitational constant, and D, is the hydraulic depth of the flow.

**denitrification** – The removal of nitrate ions from soil or water, anaerobic microbial reduction of oxidized nitrate nitrogen to nitrogen gas.

**dense graded material** - Granular mixture characterized by a large range in particle sizes. Dense graded materials have superior structural properties to open graded materials. However, they are less permeable.

**detritus** - Dead plant material that is in the process of microbial decomposition.

**diurnal** - Occurring daily or during the daylight.

**ecosystem** - All organisms and the non-living environmental factors with which they interact.

**ecotone** - The boundary between adjacent ecosystem types. An ecotone can include environmental conditions that are common to both neighboring ecosystems and can have higher species diversity.

**Eh** - A measure of the reduction-oxidation (redox) potential of soil according to a hydrogen scale.

**emergent plant** - A rooted, vascular plant that grows in periodically or permanently flooded areas and has parts of the plant (stems and leaves) extending through and above the water plane.

**eutrophic** - Water containing an excess of plant-growth nutrients that typically result in algae blooms and extreme (high and low) dissolved-oxygen concentrations.

**evapotranspiration** - The combined processes of evaporation from the water or soil surface and transpiration of water by plants.

**excessively rapid drainage** - For purposes of this manual, corresponds to infiltration rates of soils in excess of 6 inches per hour. (Normally 6 inches is considered rapid drainage but the manual indicates that special precautions need to be taken with an infiltration rate of 6 inches per hour or more)

**exfiltrate** - The leaking of water to surrounding ground through openings in structures.

**exotic species** - A plant or animal species that has been intentionally or accidentally introduced and that does not naturally occur in a region.

**extended detention** - A function provided by BMPs which incorporate a water quality storage. BMPs with extended detention, intercept runoff and then release it over an extended period of time.

**extended detention (ED) pond** - Temporarily detains part of stormwater runoff for up to 24 hours after a storm by using a fixed orifice. ED ponds normally are "dry" between storm events and do not have permanent standing water. An enhanced ED pond is designed to prevent clogging and re-suspension. It provides flexibility in achieving target detention times. It may be equipped with plunge pools near the inlet, a micropool at the outlet, and may have an adjustable reverse-sloped pipe at the ED control device.

**extended detention control device** - A pipe or series of pipes that extend from the riser of the stormwater pond that are used to gradually release stormwater from the pond over a 12- to 48-hour interval.

**fascine** - Bundled willow cuttings used to stabilize stream banks. Bundling allows otherwise weak green twigs to reinforce each other and resist the forces of stream currents.

**field capacity** - The quantity of water which will not freely drain from the root zone of shallow soil layers. Usually measured as the moisture content (by volume) in soil at a capillary tension of .33 bars.

**filter strip** - A vegetated boundary characterized by uniform mild slopes. Filter strips may be provided down-gradient of developed tracts to trap sediment and sediment-borne pollutants and to reduce imperviousness. Filter strips may be forested or vegetated turf. Filter strips located adjacent to waterbodies are called buffers.

**flash boards** - Removable boards used in a weir to control water levels.

**floating aquatic plant** - A rooted or non-rooted vascular plant that is adapted to have some plant organs (generally the chlorophyll-bearing leaves) floating on the surface of the water in wetlands, lakes, and rivers.

**flood fringe** - The flood fringe occupies the distal parts of the floodplain, outside of the floodway. Complete obstruction of the flood fringe will not significantly increase flood levels. The flood fringe boundary is typically based on an increase in flood level of one foot during the 100-year return frequency flooding event.

**floodplain** – Lands adjoining a river or stream that have been or may be expected to be inundated by flood waters in a 100-year frequency flood.

**floodway** – The channel of the watercourse and portions of the adjoining floodplains which are reasonably required to carry and discharge the 100-year frequency flood. Unless otherwise specified, the boundary of the floodway is as indicated on maps and flood insurance studies provided by FEMA. In an area where no FEMA maps or studies have defined the boundary of the 100-year frequency floodway, it is assumed, absent evidence to the contrary, that the floodway extends from the stream to 50 feet from the top of the bank of the stream.

**forebay** - Stormwater design feature that uses a small basin to settle out incoming sediment before it is delivered to a stormwater BMP.

**freeboard** - The vertical distance between water surface elevation experienced during the design flood and the crest elevation of a dam, levee, floodwall or other embankment.

**fresh water** - Water with a total dissolved solids content less than 500 mg/L (0.5 parts per thousand salts).

**gabion** - Wire cage used to contain rip rap and stone. Gabions are used to increase the resistance of rip rap to movement caused by flowing water.

**geotextile** - A fabric manufactured from synthetic fiber that is designed to achieve specific engineering objectives, including seepage control, media separation (e.g., between sand and soil), filtration, or the protection of other construction elements such as geomembranes.

**greenway** - A strip or belt of vegetated land that typically includes both upland and riparian areas. Greenways are often used for recreation, as a land use buffer, or to provide a corridor and habitat for wildlife.

**habitat** - The environment occupied by individuals of a particular species, population, or community.

**headwall** - A wall of stone, metal, concrete, or wood at the end of a culvert or drain to protect fill from scour or undermining, increase hydraulic efficiency of conduit, divert flow, retard disjuncting of short sectional pipe, or serve as a retaining wall.

**heavy metals** - Metallic elements having atomic weights above 21 on the periodic table.

**herbaceous** - Plant parts that contain chlorophyll and are non-woody.

**hydraulic conductivity (K)** - An expression of the readiness with which a liquid such as water flows through a soil in response to a given potential gradient. Hydraulic conductivity is a constant physical property of soil or rock, one of several components responsible for the dynamic phenomenon of flow.

**hydraulic loading rate (HLR)** - Ratio of the surface area of a hydraulic device and the average rate at which water is delivered to the A measure of the application of a volume of water to a land area with units of volume per area per time or simply reduced to applied device water depth per time (for example,  $m^3/(m^2/d)$  or  $cm/d$ ).

**hydraulic residence time (HRT)** - A measure of the average time that water occupies a given volume with units of time. The theoretical HRT is calculated as the volume divided by the flow (for example,  $m^3/(m^2/d)$ ). The actual HRT is estimated on the basis of tracer studies that used conservative tracers such as lithium or dyes.

**hydric soil** - A soil that is saturated, flooded, or ponded long enough during the growing season to develop anaerobic conditions. Hydric soil that is in areas having indicators of hydrophytic vegetation and wetland hydrology is wetland soil.

**hydrograph** - A record of the change in flow rate with time.

**hydrologic soil group** - A designation developed by the NRCS which describes the infiltration capacity of soil. Soil associations are categorized in decreasing infiltration capacity from A to D.

**hydroperiod** - The period of wetland soil saturation or flooding. Hydroperiod is often expressed as a number of days or a percentage of time flooded during an annual period (for example, 25 days or 7 percent).

**infiltration** - The entrance of surface water into the soil, usually at the soil/air interface.

**infiltration testing** - Specific tests designed to measure the saturated movement of water into the soil in a single direction downward through a two dimensional soil surface.

**lacustrine** - The deep-water zone of a lake or reservoir.

**limnetic** - Relating to or inhabiting the open water part of a freshwater body with a depth that light penetrates. The area of a wetland without emergent vegetation.

**littoral zone** - The shoreward zone of a lake or wetland. The area where water is shallow enough for emergent vegetation to dominate.

**macrophyte** - Macroscopic (visible to the unassisted eye) vascular plants.

**manning's equation** - A formula for calculating the anticipated uniform flow in an open-channel flow, published by Manning in 1890.

**marsh** - A wetland dominated by herbaceous emergent plants.

**micronutrient** - A chemical substance that is required for biological growth in relatively low quantities and in small proportion to the major growth nutrients. Some typical micronutrients include molybdenum, copper, boron, cobalt, iron, and iodine.

**mitigation** - The replacement of functional values lost when an ecosystem is altered. Mitigation can include replacement, restoration, and enhancement of functional values.

**nitrification** - Biological transformation (oxidation) of ammonia nitrogen to nitrite and nitrate forms.

**nitrogen fixation** - A microbial process in which atmospheric nitrogen gas is incorporated into the synthesis of organic nitrogen.

**open graded material** - Uniform granular mixture with a narrow distribution of grain sizes. Open graded material has higher permeability than dense graded material.

**organic nitrogen (Org-N)** - Nitrogen that is bound in organic compounds.

**palustrine wetland** - All nontidal wetlands dominated by trees, shrubs, persistent emergents, emergent mosses, or lichens; and all such tidal wetlands in areas where salinity from ocean-derived salts is below 0.5 parts per thousand.

**peak attenuation storage** - The volume set aside within a BMP for the purpose of attenuating the inflow runoff peak rate.

**percolation** - The downward movement under the influence of gravity of water under hydrostatic pressure through the interstices of the rock or soil.

**perennial** - Persisting for more than one year. Perennial plant species persist as woody vegetation from year to year or resprout from their rootstock annually.

**periphyton** - The community of microscopic plants and animals that grows on the surface of emergent and submergent plants in water bodies.

**permeability** – The ability of rock, soil or other material to transmit a gas or liquid.

**permittivity (cross-plane flow capacity)** - Rate that water will flow freely through a thin layer, such as a geotextile. Equal to the hydraulic conductivity divided by the thickness of the layer. Permittivity is measured in units of inverse time (e.g.,  $\text{sec}^{-1}$ ).

**photic zone** - The area of a water body receiving sunlight.

**piezometric surface** - The surface defined by elevation to which groundwater will rise in a well.

**plant community** - All of the plant species and individuals occurring in a shared habitat or environment.

**plug flow** - Linear flow along the length of a wetland cell. Ideal plug flow does not involve the dispersion or diffusion of constituents. The flow can be perceived as a series of independent "packets" of water that do not interact with each other.

**plunge pool** - A small permanent pool at either the inlet to a BMP or at the outfall from a BMP. The primary purpose of the pool is to dissipate the velocity of stormwater runoff.

**pollutant removal** - Removing pollutants by decomposing them or eliminating them from an area or system (eg. volatilize), or rendering non-harmful or unavailable in a soil or medium by means of adsorption, chelation, and similar binding mechanisms.

**pore space** - Open space in rock or granular material; also known as interstices.

**precipitation** - A deposit on the earth of hail, mist, sleet, rain or snow.

**protozoa** - Small, one-celled animals including amoebae, ciliates, and flagellates.

**receiving water** - A water body into which wastewater or treated effluent is discharged.

**recharge** - Replenishment of groundwater reservoirs by infiltration through permeable soils.

**return period (storm event)** - The average period of time between the occurrence of storms of equal or greater magnitude. The probability that such a storm will occur in any given year is equal to the reciprocal of the return period (e.g. there is a 50% chance that a 2-year storm event will occur in any given year, but only a 10% chance that a 10-year storm event will occur).

**rhizosphere** - The chemical sphere of influence of plant roots growing in flooded soils. Depending on the overall oxygen balance (availability and consumption), the rhizosphere can be oxidized, resulting in the presence of aerobic soil properties in an otherwise anaerobic soil environment.



**riparian** - Pertaining to a stream or river. Also, plant communities occurring in association with any spring, lake, river, stream, or creek through which waters flow at least periodically.

**riparian corridor** - Narrow strip of land, centered on a stream, that includes the floodplain as well as related riparian habitats adjacent to the floodplain.

**riverine wetlands** - Wetlands associated with rivers.

**runoff capture design storm** - Benchmark rainfall event, used to develop criteria for designing the groundwater recharge function of BMPs. The runoff capture design storm is the largest rainfall event from which no appreciable runoff is expected to occur. Complete specification of the storm includes the rainfall depth in inches, return frequency and storm duration. The distribution of rainfall in Pennsylvania is a Type II rainfall distribution. See Section 5.3 of the Handbook.

**runoff capture storage** - The combined storage volume provided by BMPs on a site for the retention and eventual infiltration of rainfall.

**runoff capture volume** - The minimum volume of rainfall that should be retained and completely infiltrated onsite during every storm. It is also equal to the rainfall quantity associated with the runoff capture design storm. The runoff capture volume is conveniently stated as a rainfall volume, in inches, over the area of the site.

**runoff curve number (CN)** - A parameter developed by the NRCS which is an indicator of runoff potential. Curve number is related to hydrologic soil group and land use type. The larger the runoff curve number, the greater the percentage of rainfall that will appear as runoff.

**runoff peak attenuation design storm** - Benchmark rainfall event, used to develop criteria for the design of runoff peak attenuation BMPs. The design criteria generally requires that the predicted post development peak runoff rate for the selected runoff peak attenuation design storm will not exceed the peak associated with redeveloped condition. Complete specification of the storm includes rainfall depth in inches, return frequency and storm duration. The distribution of rainfall in Pennsylvania is a Type II rainfall distribution. See Section 5.3 of the Handbook.

**saturated soil** - Soil in which the pore space is completely filled with water.

**seasonally high water table** - Shallow water tables associated with periods of recent high levels of precipitation and/or low levels of evapo-transpiration. Frequently determined in the spring.

**seed bank** - The accumulation of viable plant seeds occurring in soil and available for germination under favorable environmental conditions.

**setback** - A distance from the edge of a water body within which intensive development is restricted. Setbacks are established by local regulation for the purpose of maintaining open

space next to streams, lakes, and other water bodies. The area within setbacks is frequently used for flood control, recreation, preservation of drinking water supply, and wildlife habitat enhancement.

**sheet flow** - Water flow with a relatively thin and uniform depth.

**short-circuit** - A faster, channelized water flow route that results in a lower actual hydraulic residence time than the theoretical hydraulic residence time. This may reduce the effectiveness of a BMP.

**spillway design flood (SDF)** - Benchmark rainfall event, used to develop criteria for the design of BMPs that incorporate emergency spillways or overflows. Complete specification of the storm includes rainfall depth in inches, return frequency and storm duration. The distribution of rainfall in Pennsylvania is a Type II rainfall distribution. See Section 5.3 of the Handbook.

**stage-area curve** – A line graph showing the relationship between the depth of water and the surface area of a pond, wetland, or lake.

**stage-discharge curve** – a line graph showing the relationship between water depth and outflow from a body of water.

**subcritical flow** - The state of flow when the depth is greater than the critical depth.

**substrate** - Substances used by organisms for growth in a liquid medium. Surface area of solids or soils used by organisms to attach.

**succession** - The temporal changes of plant and animal populations and species in an area that has been disturbed.

**super critical flow** - The state of flow when the depth is less than the critical depth. Transitions between supercritical and sub-critical flow may result in turbulence associated with a hydraulic jump.

**surface infiltration rate** - The rate at which water enters the soil or other porous surface. The measurement of surface infiltration rates requires that the underlying soil be completely saturated and that infiltration occurs by gravity under a unit hydraulic gradient.

**tailwater condition—minimum and maximum** - The depth of water in the receiving water body at a structure outfall.

**terrestrial** - Living or growing on land that is not normally flooded or saturated.

**total nitrogen (TN)** - A measure of all organic and inorganic nitrogen forms in a water sample. Functionally, TN is equal to the sum of TKN and  $\text{NO}_3 + \text{NO}_2\text{-N}$ .

**total organic carbon (TOC)** - A measure of the total reduced carbon in a water sample.

**total phosphorus (TP)** - A measure of the total phosphorus in a water sample, including organic and inorganic phosphorus in particulate and soluble forms.

**total suspended solids (TSS)** - A measure of the filterable matter in a water sample.

**tractive force** - The total cross-sectional force experienced by a rigid channel or conduit as a result of channel flow (expressed in units of force per length). This force tends to displace soil particles, rocks and channel liners in the downstream direction and must be resisted by friction or by structural anchors. The tractive force is equal to the unit tractive force multiplied by the wetted perimeter of the conduit.

**transition zone** - The area between habitats or ecosystems (see ecotones). Frequently, transition zone is used to refer to the area between uplands and wetlands. In other cases, wetlands are referred to as transitional areas between uplands and aquatic ecosystems.

**transmissivity (in-plane flow capacity)** - Rate that water can be made to flow through the cross section of a thin layer or conduit under the influence of a unit hydraulic gradient. Measured as a volumetric rate per unit width (e.g., square feet meters per minute, or gallons per minute per foot). Equal to the hydraulic conductivity times the thickness of the layer or conduit.

**transpiration** - The transport of water vapor from the soil to the atmosphere through growing plants.

**type II rainfall distribution** - Standard NRCS 24-hour rainfall distribution which applies to the state of Pennsylvania. The distribution allocates rainfall as a percentage of total rainfall over discrete time intervals.

**uniformity coefficient** - A measure of the range in particle sizes associated with a granular mixture. Materials with the lowest uniformity coefficients are most uniform. Uniform materials are also called open graded materials. If the uniformity coefficient is less than 4 or 5, the material is considered uniform in particle size. The uniformity coefficient is computed as follows:

$$C_u = (D_{60} / D_{10})$$

$D_{60}$  is the sieve opening size through which 60 percent of the layer material will pass.  $D_{10}$  is the sieve opening size through which 10 percent of the layer material will pass.

**unit tractive force (or tractive stress)** - The stress (expressed in units of force per area) induced by open channel flow on the bottom and sides of its conduit or channel. This stress is responsible for sediment erosion and the downstream transport of streambed materials. The average unit force acting on a channel cross-section is equal to the product of the unit weight of water, the slope of the channel, and the hydraulic radius of the flow.

**upland** - An area that is not an aquatic, wetland, or riparian habitat. An area that does not have the hydrologic regime necessary to support hydrophytic vegetation.

**water quality design storm** - Benchmark rainfall event, used to develop criteria for the design of water quality BMPs. Water quality design storms are used to size BMPs that are intended to achieve specific quality treatment objectives. Criteria based on water quality storms generally require that the design treatment efficiency be achieved during the water quality design storm and all smaller events. Complete specification of the storm includes rainfall depth in inches, return frequency and storm duration. The distribution of rainfall in Pennsylvania is a type II rainfall distribution. See Section 5.3 of the Handbook.

**water quality storage** - The volume set aside within a BMP to detain storm runoff. The detained water is released over an extended period of time. The water quality storage is frequently expressed as a multiple of the water quality volume.

**water quality velocity** - The maximum flow velocity encountered in a water quality BMP during the course of the water quality design storm.

**water quality volume** - The total volume of runoff which is delivered to the inlet of a water quality BMP during the course of the water quality design storm.

**wattles** - Fence or barrier constructed of interwoven twigs and branches used to stabilize soil from erosive forces.

**weir** - A device used to control and measure water flow.

**weir gate** - Water-control device used to adjust water levels and measure flows simultaneously.

**wetland** - An area that is inundated or saturated by surface water or groundwater at a frequency, duration, and depth sufficient to support, and that under normal circumstances do support, a prevalence of vegetation typically adapted for life in saturated soil conditions, including swamps, marshes, bogs and similar areas.

**wilting point** - Quantity of water which will not be removed from soil under normal conditions of evaporation and plant transpiration. Usually measured as the moisture content (by volume) in soil with a capillary tension of 15 bars.

**zonation** - The development of a visible progression of plant or animal communities in response to a gradient of water depth or some other environmental factor.

